



# Alignment Feasibility Study for the Core-2-Coast Trail

**Southern Section**

Final Report

December 2024



# Alignment Feasibility Study for the Core-2-Coast Trail

## Southern Section

Prepared For:



980 North Jefferson Street  
Jacksonville, FL 32209

Prepared By:



225 Water Street, Suite 1510  
Jacksonville, FL 32202

Contract No. P-21-018  
Task Authorization No. 7  
UPWP Task 5.24

December 2024

# TABLE OF CONTENTS

<b>EXECUTIVE SUMMARY .....</b>	<b>VII</b>
<b>1 INTRODUCTION .....</b>	<b>1</b>
1.1 Trails and Shared Use Paths .....	1
1.2 The Importance of Urban Trails in Cities .....	3
1.3 Development of the Report .....	3
<b>2 TRAIL ALIGNMENT .....</b>	<b>4</b>
2.1 Trail Typical Section .....	4
2.2 Initial Trail Alignment Options .....	4
2.3 Data Collection and Field Review .....	7
2.4 Corridor Typical Sections .....	7
<b>3 PUBLIC ENGAGEMENT .....</b>	<b>9</b>
3.1 Interagency Coordination .....	9
3.2 Online Survey .....	9
<b>4 TRAIL FACILITIES IN UTILITY CORRIDORS .....</b>	<b>14</b>
<b>5 ALIGNMENT EVALUATION .....</b>	<b>19</b>
5.1 Evaluation Criteria and Scoring .....	19
5.1.1 SUP/Trail Status .....	19
5.1.2 Right-of-Way .....	19
5.1.3 Number of Through Lanes on Adjacent Street .....	19
5.1.4 Posted Speed Limit .....	19
5.1.5 Daily Traffic Volume .....	20
5.1.6 Community Access .....	20

5.1.7	Equity.....	20
5.1.8	Transit Access.....	21
5.1.9	Total Evaluation Score.....	21
5.2	Recommended Alignment.....	33
5.3	Cost Estimate.....	37
<b>6</b>	<b>NEXT STEPS.....</b>	<b>41</b>

## LIST OF TABLES

Table 1 – Summary of Data and Sources for RCI .....	8
Table 2 – Benefits from Joint Use of Utility Corridors/Property for Shared Use Paths .....	15
Table 3 – Evaluation Criteria and Scoring .....	22
Table 4 – Status of Multimodal Facilities Along Recommended Alignment.....	35
Table 5 – Construction Cost Estimate .....	40

## LIST OF FIGURES

Figure 1 – Study Area.....	2
Figure 2 – Shared Use Path Typical Section.....	4
Figure 3 – Existing, Funded and Proposed Bicycle and Pedestrian Facilities .....	5
Figure 4 – Potential SUP Alignments by Owner and Facility Status .....	6
Figure 5 – Survey Respondents .....	11
Figure 6 – Satisfaction with Trails and Desired Amenities .....	12
Figure 7 – Likelihood of Using Trail.....	13
Figure 8 – JEA Parcels in Relation to Bicycle and Pedestrian Facilities.....	16
Figure 9 – High Power Transmission Corridors by Ownership.....	17
Figure 10 – Shared Use Path Status .....	24
Figure 11 – Right-of-Way Ownership .....	25
Figure 12 – Number of Lanes.....	26
Figure 13 – Posted Speed Limit .....	27
Figure 14 – Average Annual Daily Traffic .....	28
Figure 15 – Community Access.....	29
Figure 16 – Equity.....	30
Figure 17 – Transit Access .....	31
Figure 18 – Total Evaluation Scores .....	32
Figure 19 – Recommended Alignment.....	34
Figure 20 – Core-2-Coast Trail Links.....	39

## APPENDIX

- Appendix A Field Review Photographs
- Appendix B Existing Typical Sections
- Appendix C Feasibility of Shared Use Paths Within JEA Utility Corridors
- Appendix D Requests for Use of JEA Real Property Guidelines and Application
- Appendix E Examples, Interlocal Agreements for Joint Use of Property
- Appendix F Specific Considerations for a JEA/COJ Interlocal Agreement for a Shared Use Path
- Appendix G Example, Memorandum of Understanding, City of Bellingham, WA
- Appendix H Alignment Evaluation Scoring
- Appendix I Cost Estimate for Recommended Alignment

## ACRONYMS

AADT	Annual Average Daily Traffic
BRT	Bus Rapid Transit
COJ	City of Jacksonville
FDOT	Florida Department of Transportation
GIS	Geographic Information Systems
JEA	Jacksonville Electric Authority
JPDD	Jacksonville Planning and Development Department
JTA	Jacksonville Transit Authority
LF	Linear Feet
MOU	Memorandum of Understanding
MPH	Miles per hour
PSL	Posted speed limit
RAISE	Rebuilding American Infrastructure with Sustainability and Equity
RRR	Resurfacing, Restoration and Rehabilitation
ROW	Right-of-Way
RCI	Roadway Characteristics Inventory
S.R.	State Road
SUN Trail	Shared-Use Nonmotorized (SUN) Trail
SUP	Share Use Path
TPO	Transportation Planning Organization
UNF	University of North Florida

## EXECUTIVE SUMMARY

The North Florida Transportation Planning Organization (TPO) is partnered with the City of Jacksonville (COJ) to determine the most feasible alignment for a continuous shared-use path (SUP), oftentimes referred to as a “trail,” to extend from the Fuller Warren bicycle-pedestrian bridge in the Riverside/San Marco area of Jacksonville to the beach communities on the eastern border of Duval County (Atlantic Beach, Neptune Beach and Jacksonville Beach). This “core to coast” trail represents an exciting opportunity to provide regional connectivity and expand bicycle and pedestrian access across the City.

Trails serve as transportation corridors, connecting neighborhoods with schools, parks and transit. Other top benefits are that they provide opportunities for a safe place for people to enjoy recreational activities, community identity, health and fitness, and social connection. Jacksonville consistently ranks in the top 20 metro areas for pedestrian deaths, as determined by Smart Growth America’s annual *Dangerous by Design* report. Indeed, more than 100 people are killed on Jacksonville roadways each year and between a quarter and a third of the victims are pedestrians or bicyclists – mostly people on foot.

As depicted in Figure ES-1, the recommended alignment for the Core-2-Coast trail spans approximately 25 miles across the southeast quadrant of Jacksonville. As provided in Figure ES-2, it connects 17 schools, 12 parks and nearly 80 transit stops as it meanders through multiple neighborhoods, including St. Nicholas, Spring Park, South Point, Town Center and University of North Florida, Kernan, East Arlington and Mayport.

The trail is envisioned primarily as a 10-12-foot SUP, using existing ROW. The alignment incorporates existing and planned multimodal facilities, like the Kernan Boulevard side path, with gaps connected by new construction, road diets and/or widening existing sidewalks. A cycle track or sharrows on low traffic residential streets may be used on short ROW constrained segments. The overall project is estimated to cost approximately \$25 million.

Ultimately, the Core-2-Coast trail will connect the Emerald Trail and urban core neighborhoods to the East Coast Greenway, a multimodal path which extends through Florida’s coastal cities and 14 other states for 3,000 miles from Maine to Florida.



# Preferred Core to Coast Trail Alignment Map

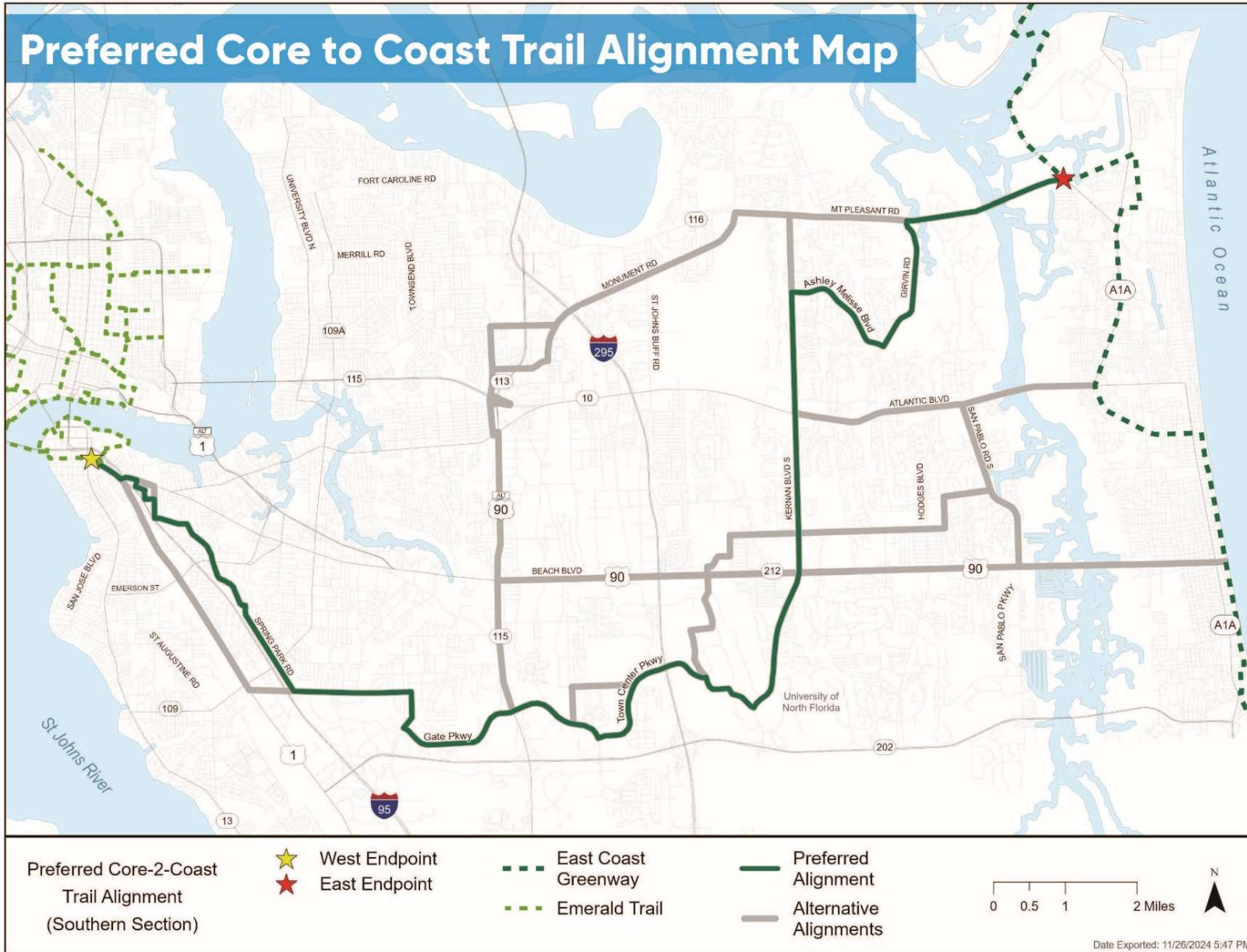

# Preferred Core to Coast Trail Alignment

## Southern Section

Alignment Feasibility Study Highlights

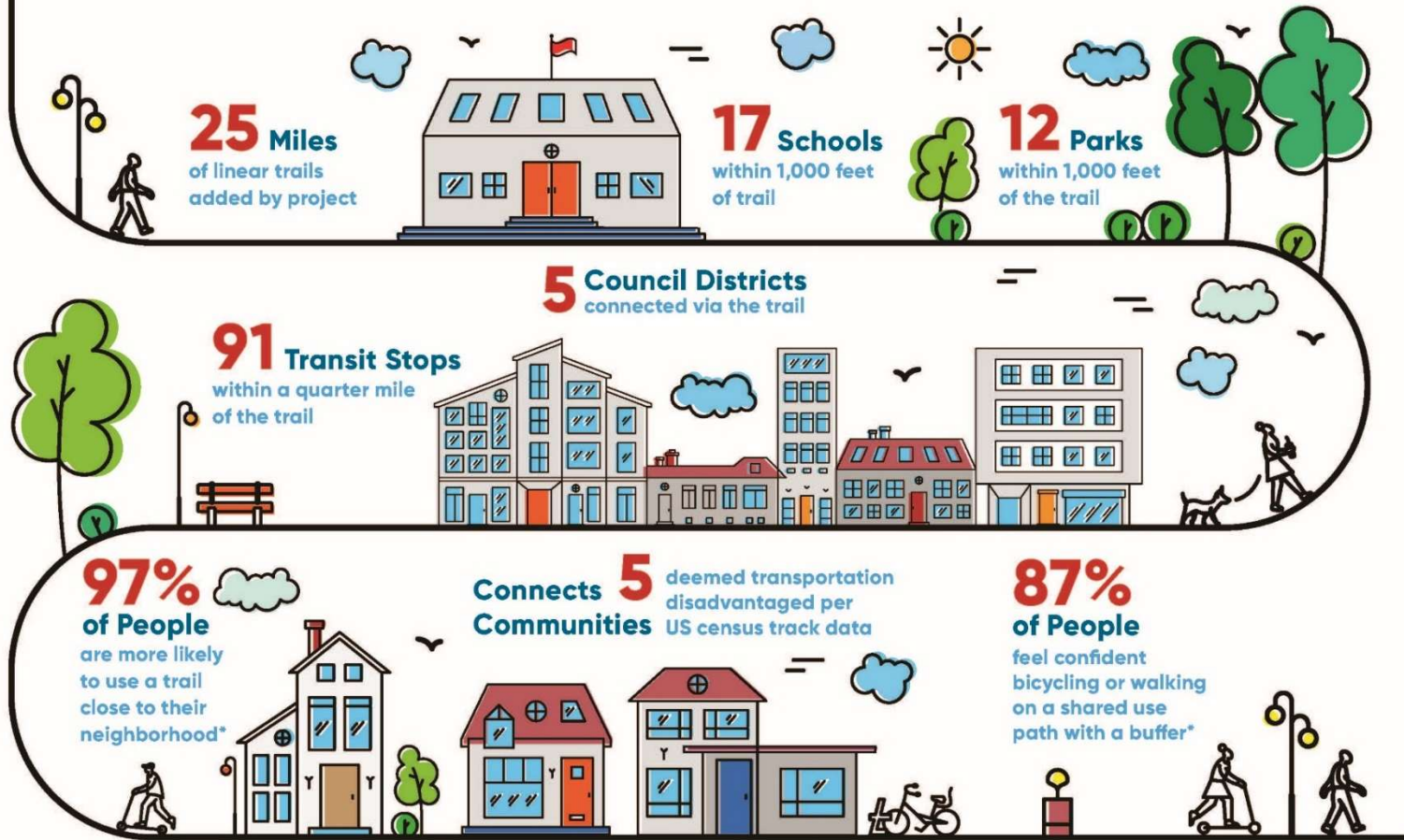

\*Per study survey

Figure ES - 2

Communities within Florida and throughout the country have successfully co-located greenways and trails within utility corridors. Examples include Duke Energy Trail (Pinellas County, FL), TECO Gas Auburndale Trail (Auburndale, FL) and Suncoast Trail (Pasco County, FL). Providing a facility that is separated from vehicular traffic improves the user’s perception of safety and may lead to higher use of the facility. This in turn has the potential to shift more vehicle trips to bicycles or walking, which impacts the community’s overall health by increasing physical activity and reducing vehicular emissions. Increased physical activity helps to reduce healthcare costs within the community.



*An aerial view of the Starkey Park Trail, which connects to the Suncoast Trail. Note the high power transmission tower on the right. Source: Florida Greenways and Trails Foundation*

One such location is in the Town Center area, where a series of private easements may offer an alternative to the alignment using Gate Parkway and Town Center Boulevard. There are also several dozen opportunities where multimodal facilities touch or intersect JEA-owned parcels. Although the parcels are scattered and not of significant size to be used for the Core-2-Coast Trail, they provide opportunities for development of accessory uses, such as parking, water stops or rest areas.

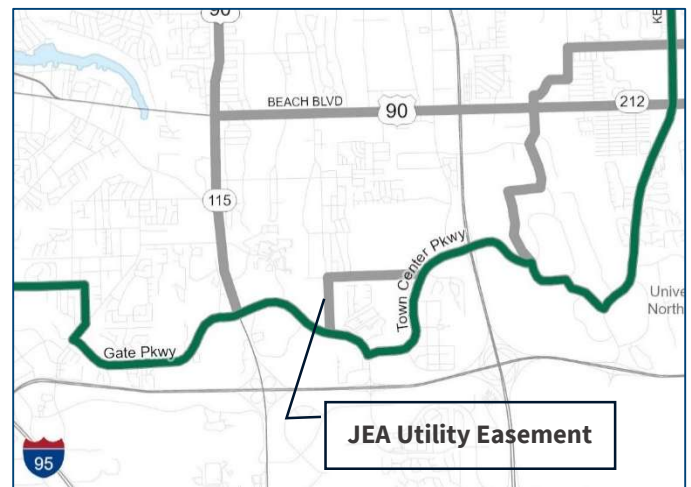

*Coordinate with JEA and private property owners to potentially use the utility easement as part of the Core-2-Coast Trail.*

Funding the trail may be accomplished in phases and utilize both capital funding and discretionary grants. Local sources include the City’s five-year capital improvement plan (CIP). Jacksonville City Council members are key allies to raise awareness of the trail, establish funding and cultivate support of residents and businesses. The Core to Coast Trail passes through multiple individual council districts (2, 3, 4, 5 and 13) plus there are five At Large council members.

The TPO identifies federally funded projects in the Transportation Improvement Program (TIP) which includes projects funded in the Florida Department of Transportation's (FDOT) Work Program. Potential projects must be added to the List of Priority Projects (LOPP).

Funding opportunities with FDOT and other state agencies include discretionary grants through SUN Trail, Transportation Alternatives Program (TAP) and Recreational Trails Program (Florida Department of Environmental Protection). Federal funding includes Rebuilding American Infrastructure with Sustainability and Equity (RAISE) grants.

The Core-2-Coast Trail represents an exciting opportunity to provide regional connectivity and expand bicycle and pedestrian access across the City. The alignment study lays the groundwork and recommendations for next steps, listed below, are intended to assist the City to continue progress and prioritize future efforts.

- Work with City Council representatives, Mayor’s Office and Public Works to prioritize trail gaps in the Capital Improvements Plan (CIP).
- Coordinate internally between JPDD and Public Works to implement recommendations in resurfacing or maintenance projects as well as upcoming capital projects.
- Coordinate with City Council members on trail alignment through individual districts. Council members are key allies to raise awareness of the trail, establish funding and cultivate support of residents and businesses.
- Coordinate with members of Jerusalem Baptist Church regarding public trail access through Jerusalem Cemetery. Meetings and correspondence should include the District 5 and At Large City Councilpersons.
- Work with JEA for opportunities to utilize utility easements for trail connections, facilities, parking, etc.
- Coordinate with FDOT District 2 where the trail meets state roadways, such as Atlantic Boulevard in St. Nicholas and on the S.R. 116 (Wonderwood Expressway) Bridge. On the bridge, there may be an opportunity to reallocate the lanes and move the concrete barrier to create a wider path, similar to what was accomplished in District 5 on the US 17/92 bridge over the St. Johns River near Sanford.
- Connect with JTA and FDOT regarding the trail alignment and road diet along Kings Road.
- Utilize the Alignment Feasibility Study in tandem with the Smart Surfaces Coalition study to lay the groundwork for Federal funding (e.g. RAISE grants) for the complete trail system.
- Investigate opportunities with FDOT and other state agencies for funding for trail segments. These include SUN Trail, Transportation Alternatives Program (TAP) and Recreational Trails Program (Florida Department of Environmental Protection).



*A paved drive winds through Jerusalem Cemetery in the St. Nicholas area of Jacksonville.*

This Alignment Feasibility Study represents the first step in this multi-year, multi-phase project. Final alignment and cross section of the Core-2-Coast Trail is dependent on an engineering implementation study which includes survey, utility coordination, ROW determination and permitting. The City must also seek funding sources and conduct community outreach and multiagency coordination to confirm the route.

# 1 INTRODUCTION

The North Florida Transportation Planning Organization (TPO) is partnered with the City of Jacksonville (COJ) to determine the most feasible alignment for a continuous shared-use path (SUP), oftentimes referred to as a “trail,” to extend from the Fuller Warren bicycle-pedestrian bridge in the Riverside/San Marco area of Jacksonville to the beach communities on the eastern border of Duval County (Atlantic Beach, Neptune Beach and Jacksonville Beach). The study area is depicted in Figure 1.

The study has regional significance because it determines best practices for connecting nonmotorized facilities between coastal communities and inland/urban areas. The alignment will connect with the East Coast Greenway, which is a common thread with all coastal cities along Florida’s coast.

The National League of Cities Smart Surfaces Coalition is concurrently developing an integrated city-wide strategy to actively manage extreme heat and stormwater through reflective (cool) roofs and pavements, porous surfaces, green roofs, solar PV, trees and rain gardens. The City’s desire is that, when considered in tandem, the studies will lay the groundwork for Federal funding (e.g. Rebuilding American Infrastructure with Sustainability and Equity (RAISE) grants) for the complete trail system.

## 1.1 TRAILS AND SHARED USE PATHS

Trails are paved areas away from the roadway that are shared by all nonmotorized transportation modes, including walking, bicycles, skateboards, mobility devices (wheelchairs, walkers, canes, scooters) and even low-speed electrical devices like eBikes and electric scooters. Examples within Duval County include the Jacksonville-Baldwin Rail Trail, Emerald Trail (S-Line Trail, LaVilla Link), Fuller Warren SUP and the Kernan Boulevard side path.



*Section of the LaVilla Link of the Emerald Trail near downtown Jacksonville.*

Not all urban trails look the same, but most are:

- Designed to be safe and comfortable enough for trail users of all ages and abilities: the “8-to-80” demographic.
- Paved (not natural ground): typically with asphalt or concrete.
- 10 linear feet (LF) to 12 LF wide, although width can vary by location from 8 LF to 14 LF.

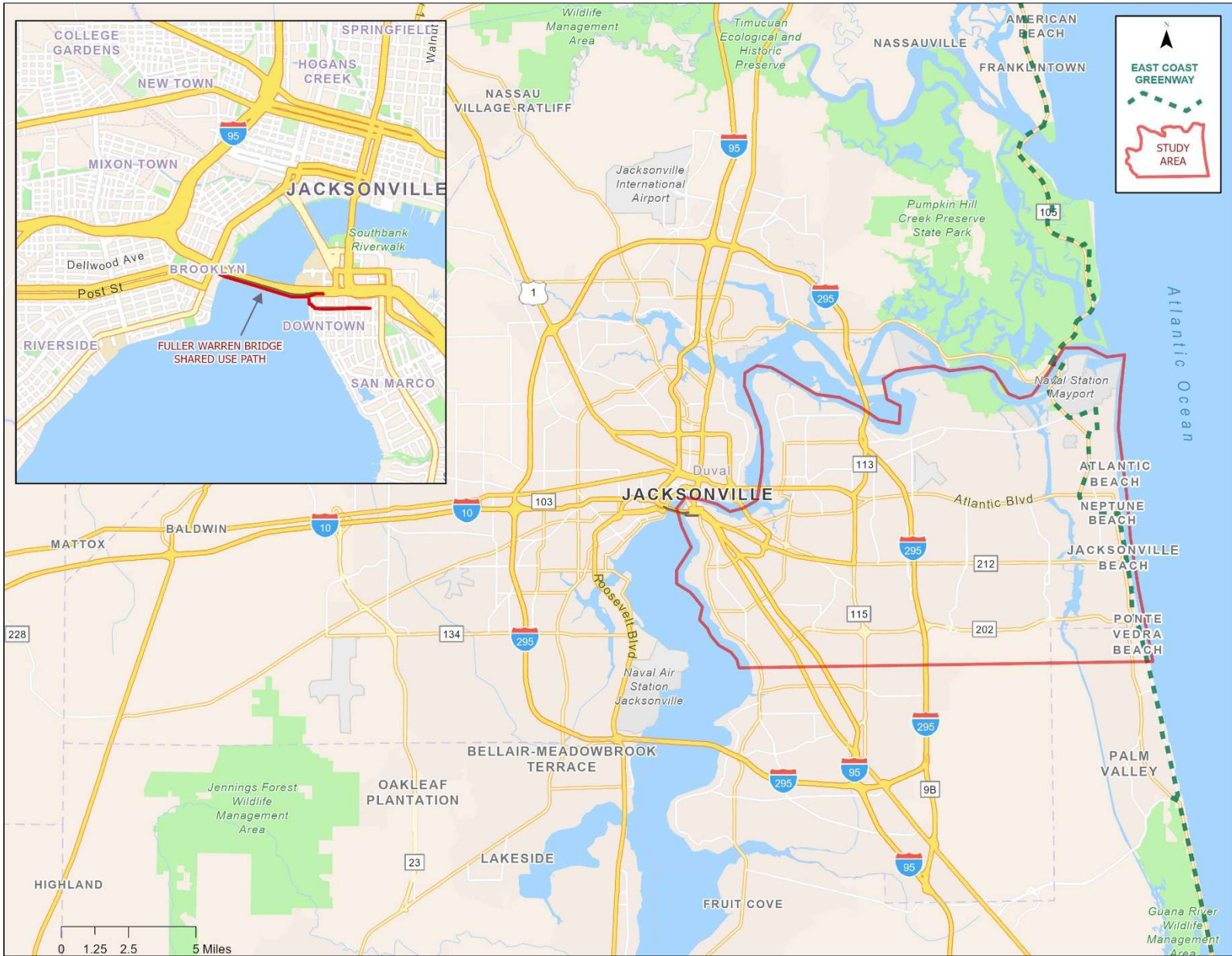

**Figure 1 - Study Area**

## 1.2 THE IMPORTANCE OF URBAN TRAILS IN CITIES

Urban trails offer many benefits to residents and visitors because they:

- Provide those biking, walking and wheeling what is generally accepted as the most comfortable and safest infrastructure for nonmotorized travel.
- Provide public spaces for people to meet, interact and enjoy active transportation.
- Provide access to employment centers, retail, public parks, health services and other essential services.
- Support improved air quality by reducing short vehicle trips that produce carbon emissions.



*Corkscrew Park on the North Bank Riverwalk is an example of an urban trail for bicyclists and pedestrians.*

## 1.3 DEVELOPMENT OF THE REPORT

Benesch analyzed the 60-square mile study area for opportunities to provide a shared use path (SUP) for bicyclists and pedestrians from downtown Jacksonville to the beaches. The City has many disconnected bicycle and pedestrian facilities. This study endeavors to “bridge the gaps” and utilize existing and funded infrastructure where possible. Benesch developed the study in phases as listed below.

- Data Collection
- Verification of typical sections and right-of-way (ROW) for potential alignments using As Built drawings and field measurements
- Development of attribute tables in Geographic Information Systems (GIS)-based shapefiles for potential alignments
- Public engagement and interagency coordination
- Utility corridor research
- Evaluation of alignments
  - Scoring criteria
  - Evaluation matrix
- Selection of preferred alignment with cost estimate

## 2 TRAIL ALIGNMENT

### 2.1 TRAIL TYPICAL SECTION

The proposed typical section for Core-2-Coast Trail is provided in Figure 2 and is based on FDOT Shared-Use Nonmotorized (SUN) Trail program standards. By using FDOT guidance, sections of the trail may be eligible for SUN Trail funding. The recommended width of the trail is 12 LF but may vary to as little as 8 LF depending upon physical or environmental constraints. Most existing facilities are 10 LF. The trail should be placed as close to the ROW line as possible with a minimum separation of 5 LF from the roadway. Sharrows may be considered for short, low volume constrained areas.

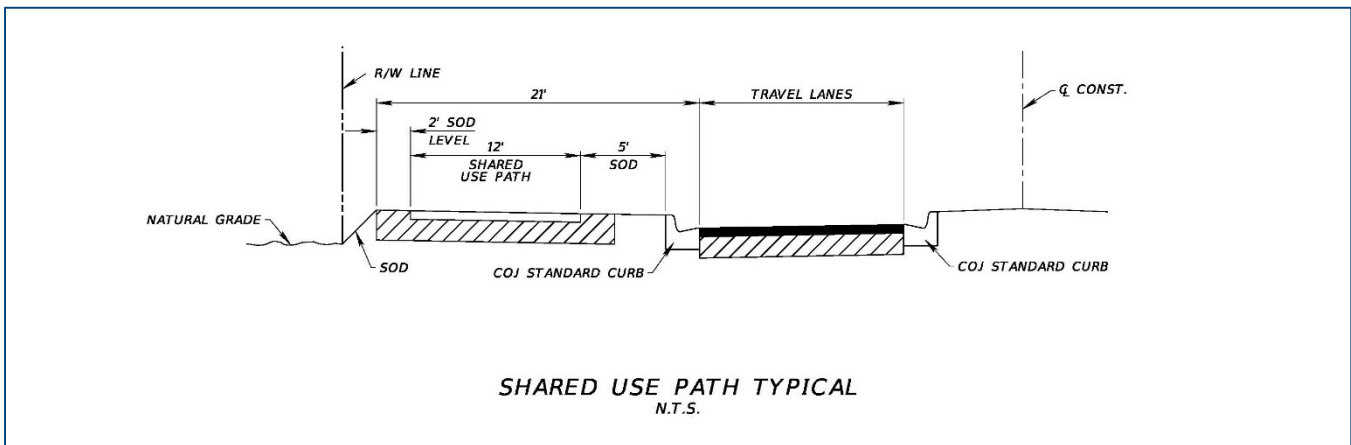

Figure 2 – Shared Use Path Typical Section

### 2.2 INITIAL TRAIL ALIGNMENT OPTIONS

A direct route between downtown Jacksonville and the beach is approximately 16 miles. However, the Core-2-Coast Trail meanders to utilize existing ROW, incorporate other multimodal facilities and pass through multiple neighborhoods. Benesch first identified existing, funded and proposed multimodal facilities within the study area, as depicted in Figure 3. We then identified corridors that have adequate ROW available and can be used to fill in missing segments to provide a continuous trail between downtown and the East Coast Greenway. These are depicted in Figure 4 and include Arlington Expressway, Bowden Road, Gate Parkway, Girvin Road, Kernan Boulevard, McCormick Road, Spring Park Road and Town Center Parkway. Options for crossing the Intracoastal Waterway are the existing bridges on State Road (S.R.) 10 (Atlantic Boulevard), S.R. 212 (Beach Boulevard) and S.R. 116 (Wonderwood Drive).



The Kernan Boulevard SUP is an existing facility that can be used as part of the Core-2-Coast Trail alignment.



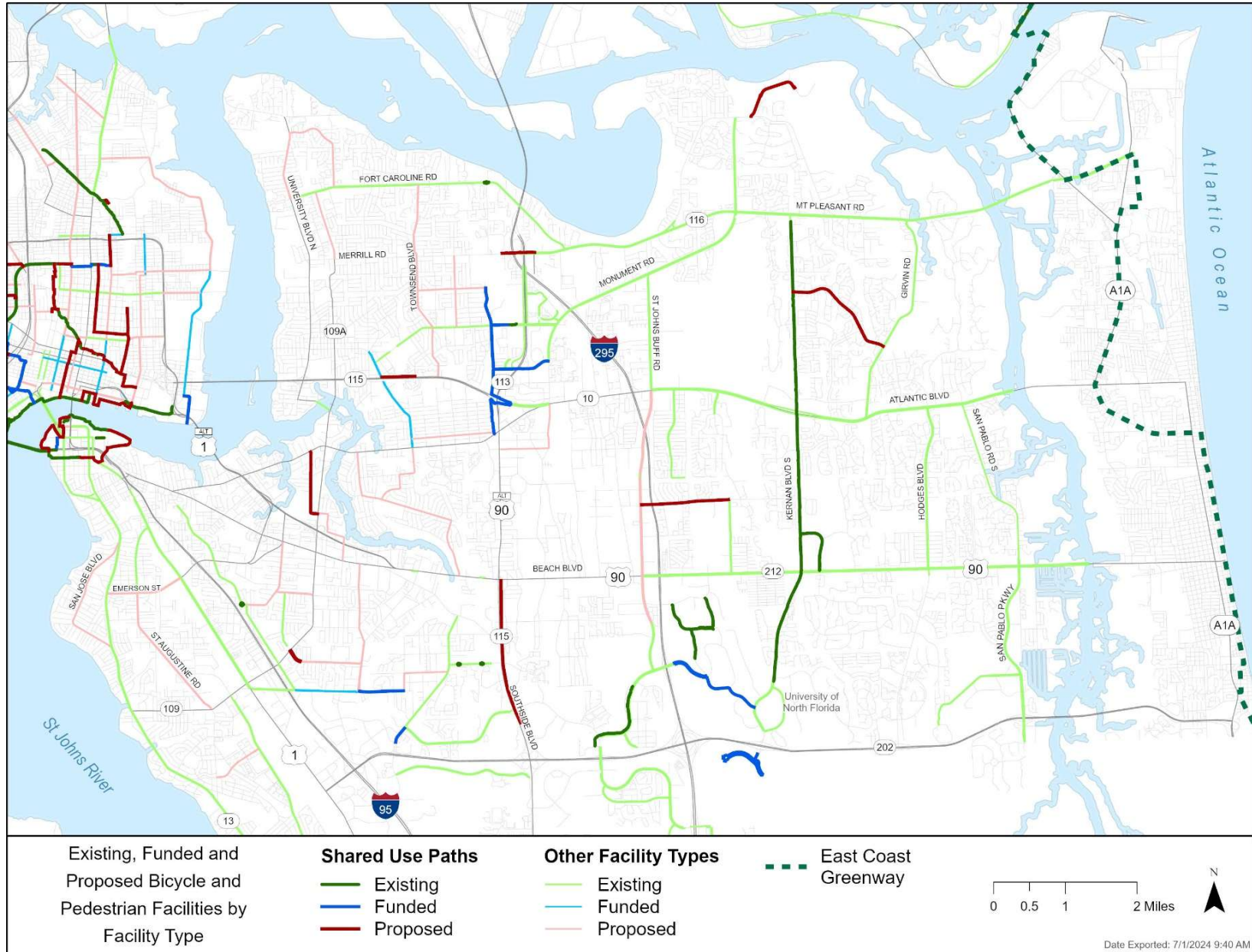

**Figure 3 – Existing, Funded and Proposed Bicycle and Pedestrian Facilities**

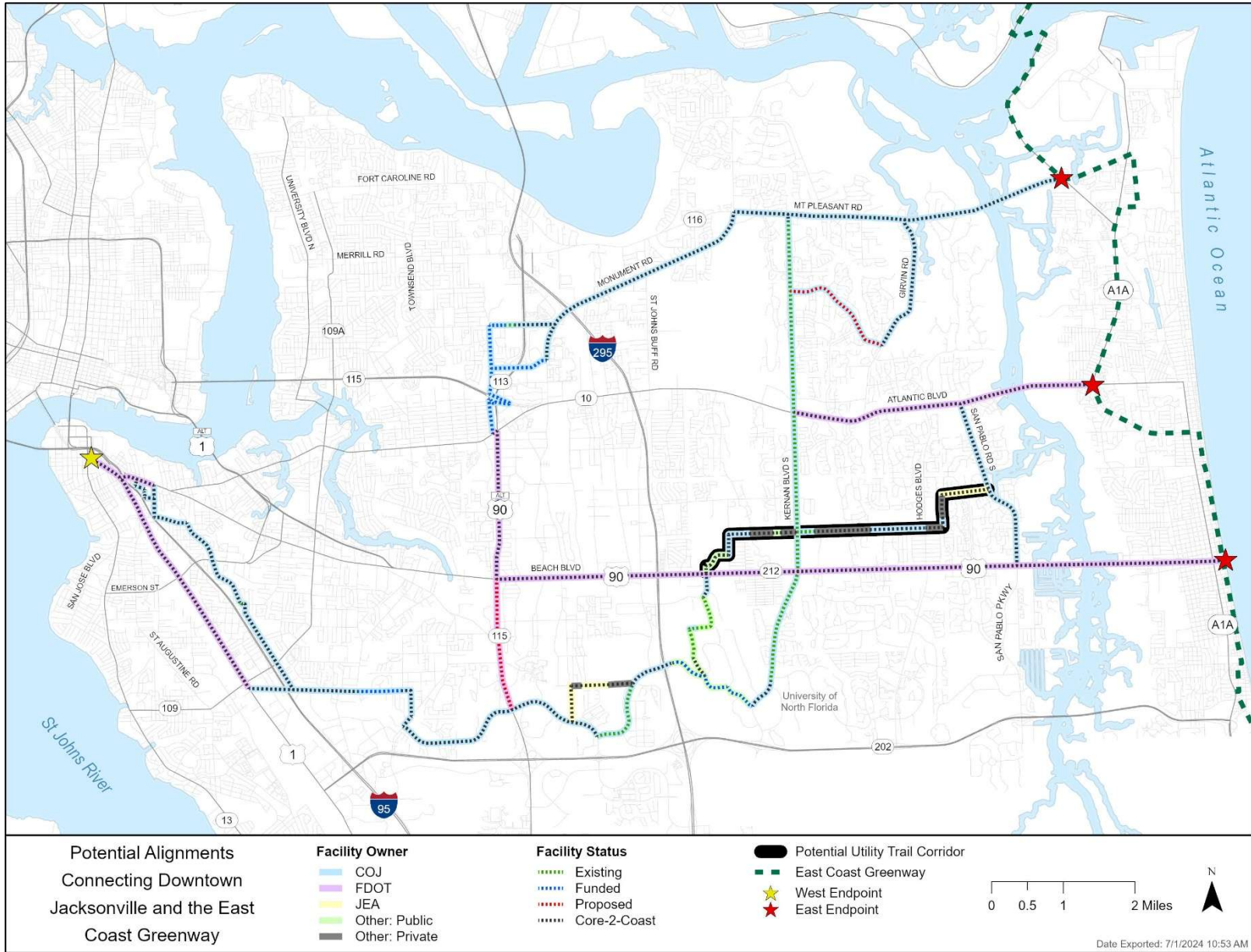

**Figure 4 – Potential SUP Alignments by Owner and Facility Status**

### 2.3 DATA COLLECTION AND FIELD REVIEW

Benesch created a Roadway Characteristics Inventory (RCI) to physically locate and document the conditions of each alignment. The RCI is based on information obtained in shapefile format from the City of Jacksonville, Florida Department of Transportation (FDOT), Florida Geographic Data Library and others. The RCI indexes each alignment by segments. For each segment, we include information on roadway features, characteristics and other data elements. Table 1 highlights the data collected and used during the study to evaluate routes.

Benesch, along with members of the TPO, City of Jacksonville Planning and Development Department (JPDD) and Traffic Engineering Division, investigated route options through field review on February 14, 2024. We provide examples of photography collected during that review in Appendix A. The review included manually validating and updating the base RCI database to 2024 conditions.

### 2.4 CORRIDOR TYPICAL SECTIONS

For the roads along the initial alignments, Benesch assembled existing typical sections using information from as built construction documents and field measurements. The existing typicals are provided in Appendix B.

The existing typical sections provide information such as ROW width, presence of bike lanes and/or sidewalk, pavement width and existing lane configuration.



*Spring Park Road has an existing bike lane and sidewalk that can potentially be repurposed for a shared use path.*

**Table 1 – Summary of Data and Sources for RCI**

Data	Source	Date
Bike Network	COJ	1/2024
Active Transit Stops	Jacksonville Transit Authority (JTA)	1/2024
Context Classification	FDOT	5/2024
Bike/Ped Crash Points (2014-2024)	CDMS	5/2024
Annual Average Daily Traffic (AADT)	FDOT, COJ	5/2024
Speed Limit	FDOT	5/2024
Road Ownership	FDOT	5/2024
Parcel Ownership	FDOR	1/2023
Plat Maps	Duval County Property Appraiser	-
Flood Zones	FEMA	12/2022
100-Year Floodplain	FEMA	12/2022
Wetlands	USFWS National Wetlands Inventory	5/2024
US Electric Power Transmission Lines	Esri US Federal Datasets	3/2024
Greenways And Trails	FDEP	3/2019
Parks	Park Serve	5/2024
Civic Centers	FGDL	1/2019
Hospitals	FGDL	9/2017
Schools	FGDL	7/2023

## 3 PUBLIC ENGAGEMENT

### 3.1 INTERAGENCY COORDINATION

Successful planning and implementation of the Core-2-Coast Trail requires coordination of alignment, upcoming projects and funding between City departments, other agencies and jurisdictions. In conjunction with the TPO, Benesch coordinated a kick off meeting with representatives from the City of Jacksonville (Transportation Planning Division, Parks Department and Traffic Engineering Division); FDOT District 2; City of Neptune Beach, Jacksonville Electric Authority (JEA), JTA and the Smart Surfaces Coalition.

As the project moves from study to design to implementation, discussion should continue among partners to include project programming (potential to add a SUP to new construction or Resurfacing, Restoration and Rehabilitation (RRR) projects), trail alignment, trailhead locations and funding opportunities. Other identified local partners include the University of North Florida (UNF), North Florida Land Trust and GroundWorks Jacksonville.

### 3.2 ONLINE SURVEY

Benesch conducted a survey to gauge public awareness, interest and support of urban trails and the Core-2-Coast Trail project. The survey was active from April 11 through May 21, 2024 and promoted through the various outlets including the TPO newsletter, Board and committees, social media, City of Jacksonville BPAC and Public Information Office, First Coast News, Jacksonville Business Journal, Jacksonville Today, North Florida Green Chamber, University of North Florida and local bicycle shops.

A total of 1,492 responses were received. Approximately 80% of the responses were from individuals between the ages of 31 and 70, with 40% from the 31 to 50 age group and 40% from the 51 to 70 age group. The respondents were evenly split between male and female, and a significant majority of the respondents (79%) identify as white or Caucasian. The three ZIP codes with the highest responses for “home” were 32250 (Jacksonville Beach), 32205 (Riverside/Avondale) and 32233 (Atlantic Beach). The three highest responses for “work” ZIP code were 32202 (downtown/Brooklyn), 32207 (Southbank/San Marco/Lakewood/Spring Park/Empire Point) and “retired/not applicable/don’t work.”

Figure Figure 5 through Figure 7 provide a visual summary of the survey results. Generally, the survey respondents are in favor of more and better trails and indicate a willingness to use them if they are provided. Restrooms, wayfinding signs and safety features (lighting and emergency call boxes) are the most important amenities for the trail. The provision of parking near the trail is also an important feature that would increase the likelihood of its use. Comments indicate a strong desire for shade on at least some of the trail.

A sample of the comments are listed below. There is strong support for the Fuller Warren SUP and Jacksonville-Baldwin Rail Trail. Many commenters are dissatisfied with the current state of sidewalks and bicycle facilities in Jacksonville, including a dearth of facilities, lack of connections and lack of maintenance. Overall, the desire is for the City to “Git er done!” and “Please do this trail!”

- *Look for opportunities to connect these paved shared use paths with existing mtb trails in the area like Hanna, Trek Trails and Tillie Fowler. Consider tax abatement or the Florida greenways and trails designation as motivation for private landowners to convert a portion of their land into trail to help make these connections easier. Just a thought.*
- *I live off beach and Hodges and have to drive all the way to the Baldwin rail trail to bike with my group because there are no other options where I live and the streets are very busy and dangerous with cars. It's way too far so I have stopped meeting the group. Gas prices are too high to drive there weekly.*
- *Love the direction you are taking this. Please consider having some sections covered with trees for shade. Full Sun is a killer in the Summer. The Baldwin trail is perfect.*
- *Would use trails if they were closer by and safe from traffic. This is the one thing I think Jacksonville lacks that so many other cities do so well. Let's get more of these trails all over town!*
- *Please, please, please build this and help make Jax safe and healthy for our kids!*
- *Trails need to be properly separated from traffic to ensure safety. A painted line and a curb are not going to protect a pedestrian or cyclist.*
- *It's disappointing to visit other cities and see their vibrant trail systems and the lack of similar systems in Jacksonville--we have so much wonderful landscape to enjoy that should be accessible via trail (especially on the waterfront!).*
- *Mimic the Atlanta beltline*
- *A lot of the trails are cut off from the main road, afraid I could be attacked.*
- *The SUP has been amazing in connecting our communities and if we could apply this concept to connect the beach with downtown I feel it would be safer for al of us that prefer to bike, run, walk*
- *The more trials, paths, the better. Let's walk and bike more.*
- *Consider Ebikes in all of this. They can travel pretty big distances with very little designated road space. Include and do not ban them on these trails.*
- *Plugs to charge along the trail for PEVs. PEVs allow me to get out even with a disability. A plug gives me piece of mind that I won't be stranded.*

# Total Participants: 1,492

93% Used an Urban Trail



**52%** In another City      **76%** In North East Florida

## In the past 12 months

**87%**  
**Walked**

<b>52%</b> Exercise/ Non-recreation	<b>35%</b> Exercise	<b>9%</b> No Response	<b>4%</b> Non-recreation
---	------------------------	-----------------------------	-----------------------------

**96%**  
**Rode a bike**

<b>89%</b> Exercise/ Leisure	<b>62%</b> Shopping	<b>56%</b> Visit Family/ Friends	<b>45%</b> Work/School/ Transit
------------------------------------	------------------------	--	---------------------------------------

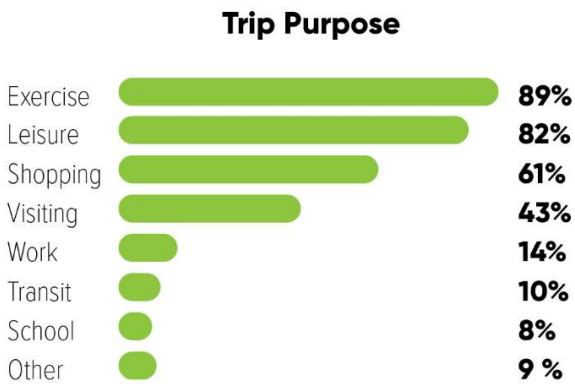

### Frequency of Bicycle Use (All Purposes)

Daily .....	<b>5%</b>
Several Times per Week .....	<b>13%</b>
Several Times per Month .....	<b>17%</b>
A Few Times per Year.....	<b>17%</b>
Never .....	<b>48%</b>

### Trip Length (All Purposes)



**70%** Would like to walk more

**72%** Would like to bike more

Figure 5 – Survey Respondents

## Barriers to Walking/Biking



### Walking

Traffic Stress .....	<b>19%</b>
Gaps .....	<b>21%</b>
Weather .....	<b>5%</b>
Lighting .....	<b>8%</b>
Condition of Path .....	<b>12%</b>
No showers/lockers .....	<b>3%</b>
Lack of Connectivity.....	<b>16%</b>
Transport other people/things.....	<b>3%</b>
Health or Physical Limitations .....	<b>1%</b>
Beyond Reasonable Distance .....	<b>10%</b>
Other.....	<b>2%</b>



### Biking

Traffic Stress .....	<b>15%</b>
Gaps .....	<b>14%</b>
Weather .....	<b>8%</b>
Lighting .....	<b>9%</b>
Condition of Path .....	<b>12%</b>
No showers/lockers .....	<b>4%</b>
Lack of Connectivity.....	<b>13%</b>
Transport other people/things.....	<b>6%</b>
Health or Physical Limitations .....	<b>2%</b>
Beyond Reasonable Distance .....	<b>9%</b>
Other* .....	<b>9%</b>

\*Refers to not having access to bike racks or secure bike parking.

### Confidence Levels by Facility Type for Both Bicycling and Walking

% Not Confident      % Somewhat Confident      % Confident

#### Shared Bike/Car Lanes



**48%**  
**37%**  
**15%**

#### Painted Buffered Bike Lane



**18%**  
**39%**  
**43%**

#### Striped/Painted Bike Lane



**26%**  
**41%**  
**33%**

#### Painted Buffered Bike Lane with Vertical Separator



**9%**  
**26%**  
**65%**

#### Shared Use Path with Buffer (Walking/Biking)



**3%**  
**10%**  
**87%**

#### Sidewalk Separated with Landscaping or Curbing (Walking Only)



**2%**  
**7%**  
**91%**

### Satisfaction with Existing Trails



**87%**  
Unhappy with  
Availability of Trails



**2**  
Average rating  
of trail options

### Important Trail Amenities



**66%**  
Restrooms



**65%**  
Lighting & Emergency  
Call boxes



**65%**  
Wayfinding Signage



**53%**  
Water Fountains



**52%**  
Parking



**52%**  
Benches

Figure 6 – Satisfaction with Trails and Desired Amenities



**Likelihood of Using Trail if Conveniently Located Near You**



Very Likely .....	<b>78%</b>
Somewhat Likely .....	<b>15%</b>
Somewhat Unlikely .....	<b>2%</b>
Very Unlikely .....	<b>4%</b>

<p><b>97%</b></p> <p>Would be more likely to use the trail if there were closer to their neighborhood</p>	<p><b>87%</b></p> <p>Would consider assisting with trail maintenance/upkeep</p>	<p><b>78%</b></p> <p>Would be more likely to use the trail if there was parking nearby</p>
---	---	--

**Figure 7 – Likelihood of Using Trail**

## 4 TRAIL FACILITIES IN UTILITY CORRIDORS

The co-location of utility corridors and greenways offers a way to efficiently use open space which would normally remain undeveloped. A trail corridor can exist with both aboveground and underground utilities, such as water, sewer, natural gas, electric and fiber optic. A spatial analysis by The Rails to Trails Conservancy estimates that more than 400 multiuse trails across the country coexist within electric utility corridor rights-of-way and approximately 17% of rail trails in the United States are at least partially shared with this type of utility corridor.<sup>1</sup>

The practice has been undertaken successfully within Florida and throughout the country. Examples include:

- Duke Energy Trail (Pinellas County, FL)
- TECO Gas Auburndale Trail (Auburndale, FL)
- Spring-to-Spring Trail (Volusia County, FL)
- Suncoast Trail (Pasco County, FL)
- Western Hills Connector (Papillion, NE)
- Horsham Powerline Trail (Horsham Township, PA)
- Power Line ROW Trail (Liberty Township, OH)
- Preston Ridge Trail (Dallas, TX)
- Trolley Line Trail (West Windsor, NJ)
- Chief Sealth Trail (Seattle, WA)



*A view of the TECO Gas Auburndale Trail (Source: [www.TrailLink.com](http://www.TrailLink.com))*

Appendix C, which is a presentation to JEA provided by the COJ Transportation Planning Division in February 2022, contains more information and photographs of these examples.

JEA is the City’s community-owned utility providing electric, water, sewer and reuse water services. The City of Jacksonville has initiated conversations on the potential to share their utility corridors and property for segments of the Core-2-Coast Trail. JEA is amenable to allowing joint use of their utility corridors for shared use paths but the City should be proactive in identifying specific locations, outlining benefits to participation, conditions/criteria for use and agreement language.

JEA already grants joint use of its property and has established “Guidelines and Application for Use of JEA Real Property.” This document provides guidance for the types of activities that may be permitted on their property, insurance requirements and establishes clearance and planting requirements. Requirements from this document should be included in any interlocal agreement developed between the City of Jacksonville and JEA for joint trail use. A copy of the document is included in Appendix D.

Figure 8 depicts JEA-owned parcels across the study area in relation to bicycle and pedestrian facilities. There are several dozen opportunities where multimodal facilities touch or intersect JEA-owned parcels. Although

<sup>1</sup> <https://www.railstotrails.org/trail-building-toolbox/utilities/>

the parcels are scattered and not of significant size to be used for the Core-2-Coast Trail, they provide opportunities for development of accessory uses, such as parking, water stops or rest areas. Once a preferred alignment is identified, the City should revisit the JEA-owned parcels along the alignment and determine if any of the parcels could benefit the trail’s development. High voltage transmission corridors, depicted in Figure 9, show potential for joint use with the Core-2-Coast Trail but a major hurdle is that JEA is not the property owner for most of the parcels. An exception is a corridor north of and parallel to S.R. 212 (Beach Boulevard), from west of Kerman Boulevard to San Pablo Road.

Regarding benefits, there are a number of reasons the joint use of utility corridors and utility-owned parcels is beneficial to both the utility company and the public. The first, and perhaps most obvious benefit, is that the cost to construct the trail is reduced since the purchase of easements and/or additional ROW from private property owners is lessened. Another important reason is the ability to separate the trail from vehicular traffic. As shown in Appendix C, the State of Florida, and the City of Jacksonville specifically, continue to be in the highest-ranking areas for bicyclist fatalities (according to the National Highway Traffic Safety Administration). In the latest edition of “Dangerous by Design” published by Smart Growth America and the National Complete Streets Coalition, the State of Florida ranks second in the highest number of pedestrian deaths per 100,000 people. The City of Jacksonville ranks sixth among metropolitan areas throughout the country.

Beyond the statistics, providing a facility that is separated from vehicular traffic improves the user’s perception of safety and may lead to higher use of the facility. This in turn has the potential to shift more vehicle trips to bicycles or walking, which impacts the community’s overall health by increasing physical activity and reducing vehicular emissions. Increased physical activity helps to reduce healthcare costs within the community. There are several benefits that accrue to the utility company, which are identified in Table 2 along with the others mentioned here.

**Table 2 – Benefits from Joint Use of Utility Corridors/Property for Shared Use Paths**

Benefit	JEA/Utility Company	City of Jacksonville	Public
Reduced cost of implementation		✓	✓
Trail naming/branding rights	✓		
Media acknowledgement and community appreciation	✓		
Potential reduction of crime and vandalism	✓		
Reduced pedestrian and bicyclist fatalities and serious injuries		✓	✓
Paved access/maintenance roads	✓		
Potential for mode shift as more people willing to walk or bike in lieu of driving		✓	✓
Potential improvement to overall community health through provision of additional active recreation opportunities		✓	✓

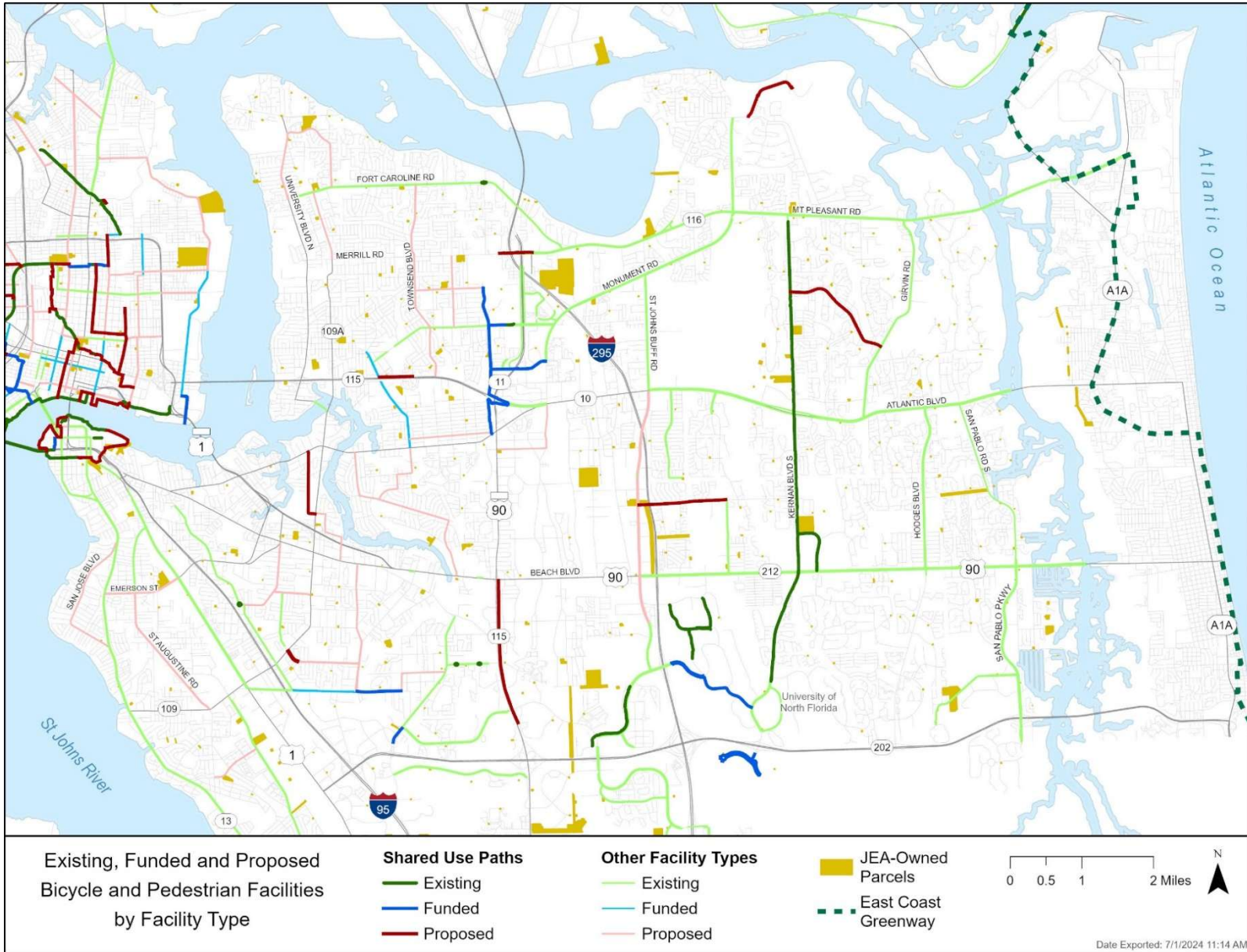

**Figure 8 - JEA Parcels in Relation to Bicycle and Pedestrian Facilities**

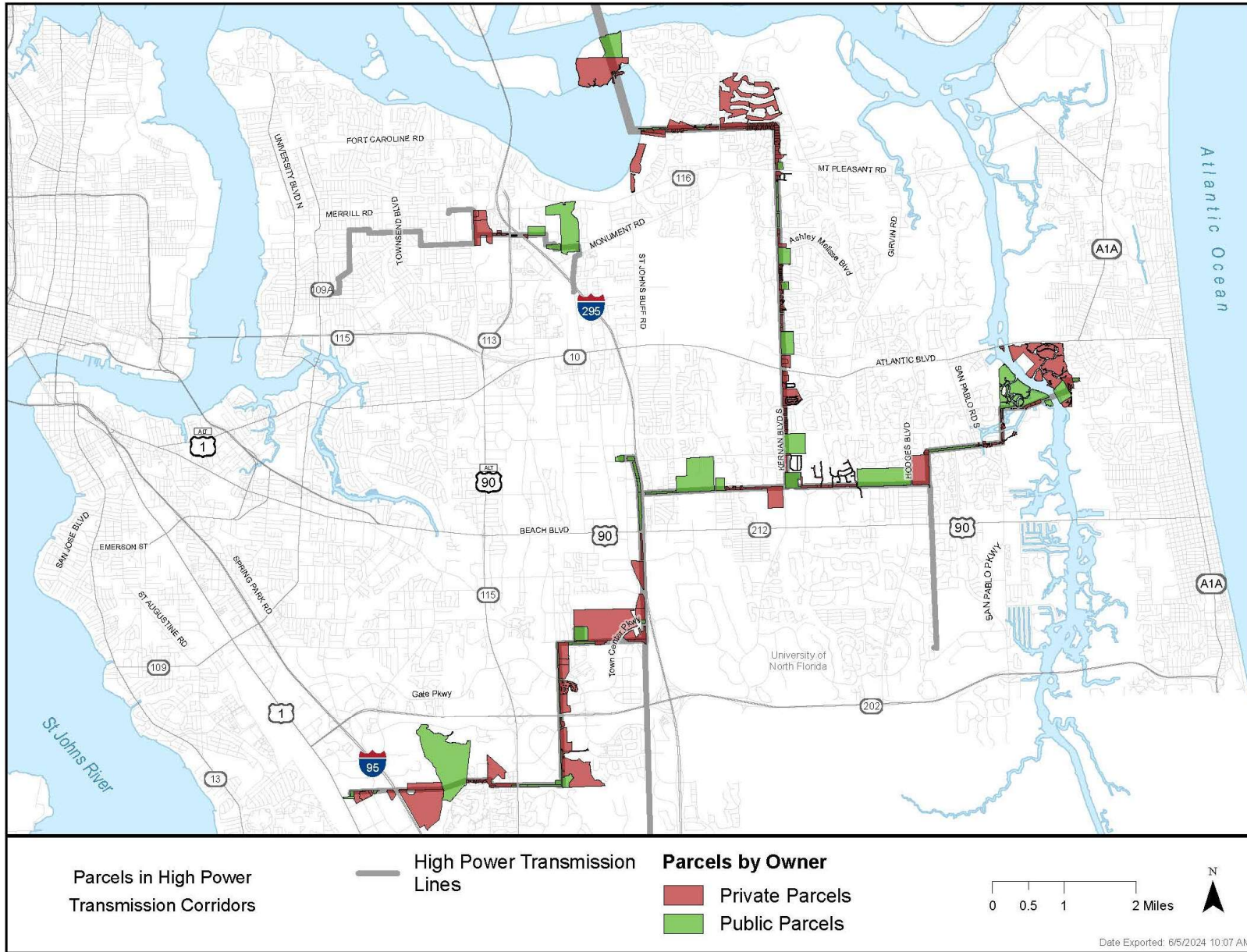

Figure 9 – High Power Transmission Corridors by Ownership

To ensure that the joint use of their property provides the greatest benefit to JEA and eliminates their risk, an interlocal agreement between JEA and the City of Jacksonville should be executed. Appendix E provides two examples of interlocal agreements executed in Texas and Florida. The following is a list of terms and conditions that should be included in this agreement. Detailed language specific to JEA's requirements is provided in Appendix F.

1. Identification, including legal description and survey, of property(ies) subject to the agreement
2. Compensation amount, if any, agreed to for use of the property
3. Term of the agreement
4. Identification of the permitted use(s), such as shared use path, parking, rest area, etc.
5. Liability, indemnity, and legal liability language
6. Ability of utility company to enter the property at any time for any purpose and to close portions of the trail or other facilities as needed
7. Agreement to provide sufficient accessways for the utility company to maintain its infrastructure
8. Maintenance responsibilities of each party, including specific activities and costs
9. Establishment of horizontal and vertical clearances from utility infrastructure
10. Agreement to maintain improvements and property in state of good repair and appearance, including remedies
11. Insurance coverage requirements
12. Return of property to as close as possible to original condition upon discontinuance of joint use

The two interlocal agreements provided in Appendix E are appropriate starting points for the development of a similar agreement between the City of Jacksonville and JEA. The example from Texas is very minimal and while it may serve the general purpose, the Duke Energy example appears to provide greater protection for all of the involved parties. This Duke Energy agreement indicates that the utility company reviewed the trail construction documents and they are incorporated into the agreement. The City should review the options with JEA to determine what best suits the needs. For example, it may serve both parties interests to enter into an agreement regarding the intent to allow for joint use once the preferred alignment is identified, and then return with a more specific agreement once sufficient design details are established.

A Memorandum of Understanding (MOU) is another option, indicating the willingness of JEA to work with the City to provide trails on JEA property. This document, which would be reviewed by the legal representatives of each party and signed by the persons with authority to make such commitments, would establish the process for coordinating the concept development of the trails and the timing for entering an interlocal agreement regarding construction and maintenance. An example MOU utilized by the City of Bellingham (Washington) is provided in Appendix G. This example is between a non-profit organization and the city's parks and recreation department. It overlaps with the information that would be provided in the interlocal agreement, so the level of detail provided in the example would not be required for such a document with JEA.

## 5 ALIGNMENT EVALUATION

### 5.1 EVALUATION CRITERIA AND SCORING

Benesch identified eight quantitative metrics to determine a favorable alignment for the Core-2-Coast Trail. The evaluation criteria balance the need for safe, comfortable and direct passage for bicyclists and pedestrians with existing, planned and funded facilities and access to the facility for all users. Other criteria help identify the best gap corridors from an end user, accessibility and feasibility perspective. Table 3 provides a summary of the criteria with the scoring for each. The criteria are described in the following sections with scoring illustrated in Figure 10 through Figure 17.

#### 5.1.1 SUP/Trail Status

Scoring prioritizes alignments that further enhance connectivity and leverage the existing multimodal network. Alignments with existing SUP facilities are assigned four points, followed by three points for alignments with funded facilities, two points for alignments with planned facilities and one point for alignments with no existing SUP facilities. The resulting scoring is depicted in Figure 10.

#### 5.1.2 Right-of-Way

Alignments along COJ owned corridors are prioritized over other road types, as the ROW is open for public access and dedicated to the city through a plat. For non-COJ roads, abutting property owners must grant the necessary ROW and/or easements for the finished trail alignment to meet the typical section.

Trail alignments adjacent to COJ-owned roads which meet the ROW criteria receive five points in the scoring matrix, while all other non-COJ public roads received a score of one and all alignments along or within private parcels receive no score. The resulting scoring is depicted in Figure 11.

#### 5.1.3 Number of Through Lanes on Adjacent Street

The number of through lanes is used in the prioritization as a measure of poor user experience and safety. A greater number of lanes is associated with longer crossing distances at intersections, higher traffic volumes and a more stressful rider experience. Alignments along roads with six or more lanes are given the lowest score, followed by four-lane roads, then two-lane roads. Alignments which are separated from adjacent roads are given the maximum score of four points. The resulting scoring is depicted in Figure 12.

#### 5.1.4 Posted Speed Limit

Posted speed limit (PSL) is used as a measure of both user experience and safety in the prioritization process. Alignments along roadways with higher speed limits are considered less pleasant and more dangerous for bicyclists and pedestrians, therefore receiving lower scores. The maximum score is three points and speed limits are grouped for scoring as follows:

- ≤25 MPH
  - Alignments not adjacent to a roadway are assigned a 0 PSL for scoring

- 30 MPH
- 35 to 40 MPH
- ≥45 MPH

S.R. 116 (Wonderwood Drive) is the only potential trail corridor with a 55 MPH PSL. All other roadways had a PSL of 45 MPH or less. The resulting scoring is depicted in Figure 13.

### 5.1.5 Daily Traffic Volume

Higher volume roadways are considered more dangerous, noisier and less enjoyable for bicyclists and pedestrians. This criterion is scored from 0 to three points: alignments adjacent to higher volume roadways are given lower scores while low volume roads or alignments not along a roadway receive the maximum score. Traffic volumes are obtained from COJ and FDOT and grouped into four classes for scoring. Roads lacking count data are assigned to one of the following classes based on other roadway characteristics and local knowledge.

- Low-volume (0 – 9,999)
  - Alignments not adjacent to a roadway are assigned an AADT of 0 for scoring
- Moderate-volume (10,000 – 19,999)
- High-volume (20,000 – 39,999)
- Very high-volume (40,000 or more)

The resulting scoring is depicted in Figure 14. Low volume roads include Bowden Road, Mill Creek Road, San Diego Road and Spring Park Road while Arlington Expressway, S.R. 10 (Atlantic Boulevard), S.R. 212 (Beach Boulevard) and S.R. 115 (Southside Boulevard) are all classified as very high-volume roadways. Kernan Boulevard, Monument Road, San Pablo Road and S.R. 116 (Wonderwood Drive) fall into the moderate or high classes.

### 5.1.6 Community Access

Alignments that provide community access – specifically to educational and recreational facilities – are prioritized. Access is defined as being within 1,000 feet of a school or park. There are 21 public schools, 20 private schools and 38 parks within this search radius. Alignments meeting this definition of community access receive one point for either facility type, for a maximum score of two. The resulting scoring is depicted in Figure 15.

### 5.1.7 Equity

To measure equity of access for all communities, scores are assigned to each alignment for three socioeconomic variables: household poverty, minority population and zero-vehicle households. Each variable is collected from the U.S. Census Bureau *2018-2022 American Community Survey 5-Year Estimates* at the Block Group level. One point is awarded per category if the alignment intersects or falls within a block group meeting a given threshold, for a maximum score of three points (i.e. the alignment intersects a block group meeting all three criteria). The United States Department of Agriculture Economic Research Council (USDA ERS) and U.S. Census Bureau standards are used to develop the scoring thresholds.



- Household Poverty
  - >20% of households in a block group are below the poverty level
- Minority Population
  - Non-Hispanic white population is less than 50%
- Zero-Vehicle Households
  - 100 or more zero-vehicle households in the block group **OR** 50% or more households in the block group have zero vehicles

The resulting scoring is depicted in Figure 16. The majority of alignment segments (51.1%) intersect at least one of the equity areas listed above while 7.6% of segments intersect block groups with all three socioeconomic indicators. Green areas with black hatching indicate equity areas where all three socioeconomic indicators are within the noted thresholds.

### 5.1.8 Transit Access

Proximity to transit stops is included in prioritization to encourage multimodal connections and enhance accessibility for transit users.

JTA operates the transit system in Jacksonville including a standard fixed route bus service and the First Coast Flyer Bus Rapid Transit (BRT) service. Between these two services, there are 14 routes and 248 stops along potential Core-2-Coast alignments.

For scoring, transit is considered accessible if the alignment is within 0.25 miles of a JTA stop. Segments within this search radius receive one point. The resulting scoring is depicted in Figure 17.

### 5.1.9 Total Evaluation Score

Overall prioritization scores are depicted in Figure 19. The maximum score across all eight criteria is 23 while the minimum score is two. Alignment segment scores range from 3 to 21 points. Mill Creek Road, Regency Square Boulevard North, Spring Park Road, Lone Star Road and a JEA-easement score the highest, with scores ranging from 18 to 21. The complete GIS data layer and scoring matrix are provided under separate cover. Individual segment scores can be reviewed in that format. City staff can easily use these materials to sort the database, change values for scoring criteria and update the records when trails are built or other conditions change.

**Table 3 – Evaluation Criteria and Scoring**

Criteria	Description	Scoring	Notes
SUP/Trail Status	Existing, planned or funded facilities	1 = No	
		2 = Planned	
		3 = Funded	
		4 = Existing	
Right of Way	Adequate ROW to add SUP/trail	0 = Private	All alignments within non-COJ public parcels were given a score of 1
		1 = Adequate (non-COJ)	
		5 = Public (COJ)	
Number of Lanes	Number of lanes of the adjacent facility	1 = 6+ lanes	“None” refers to alignments with no adjacent roadway
		2 = 4 lanes	
		3 = 2 lanes	
		4 = None	
Posted Speed Limit	Speed of motor vehicles on the adjacent facility	0 = ≥ 45 MPH	Speed limit of 0 was assigned to alignments with no adjacent roadway
		1 = 35 MPH- 40 MPH	
		2 = 30 MPH	
		3 = 0 – 25 MPH	
Traffic Volume	Motor vehicle volume on adjacent facility (ADT)	0 = ≥ 40,000 ADT	AADT of 0 was assigned to alignments with no adjacent facility
		1 = 20,000 – 39,999 ADT	
		2 = 10,000 – 19,999 ADT	
		3 = 0 – 9,999 ADT	

Criteria	Description	Scoring	Notes
Community Access	Within 1,000 ft of a park or school	0 = No	
		1 = Yes	
Equity	Non-Hispanic white population < 50%	1 point per category (max= 3)	Trail is located within a block group with 50% or less non-Hispanic white population
	>50% zero-vehicle households <b>OR</b> 100+ zero-vehicle households		Trail is located within a block group with 50% or more zero vehicle households <b>OR</b> 100+ zero vehicle households
	Household poverty > 20%		Trail is located within a block group where more than 20% of households are below the poverty level
Transit	Within 0.25 miles of a transit stop	0 = No	Jacksonville Transit Authority bus stops
		1 = Yes	

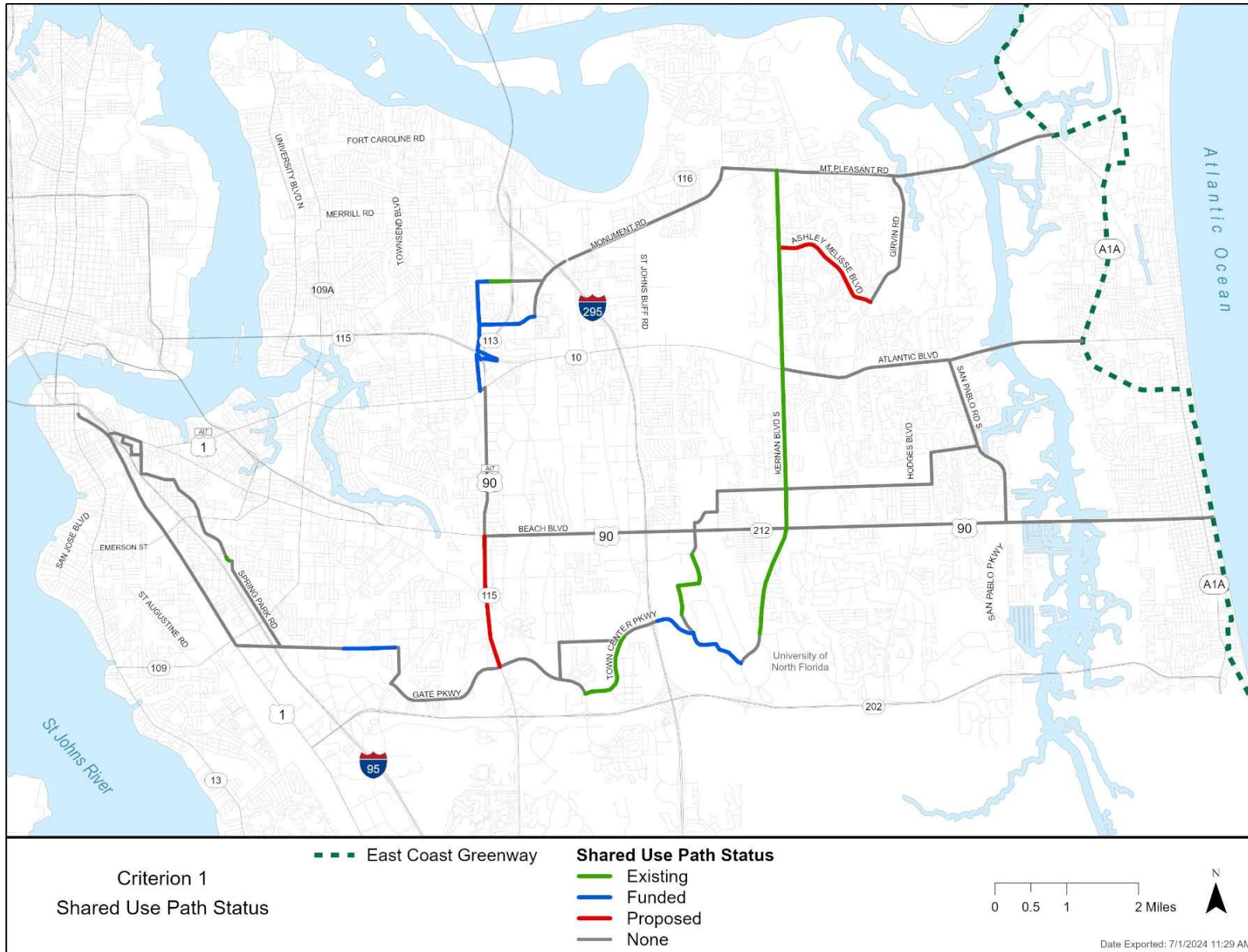

**Figure 10 - Shared Use Path Status**

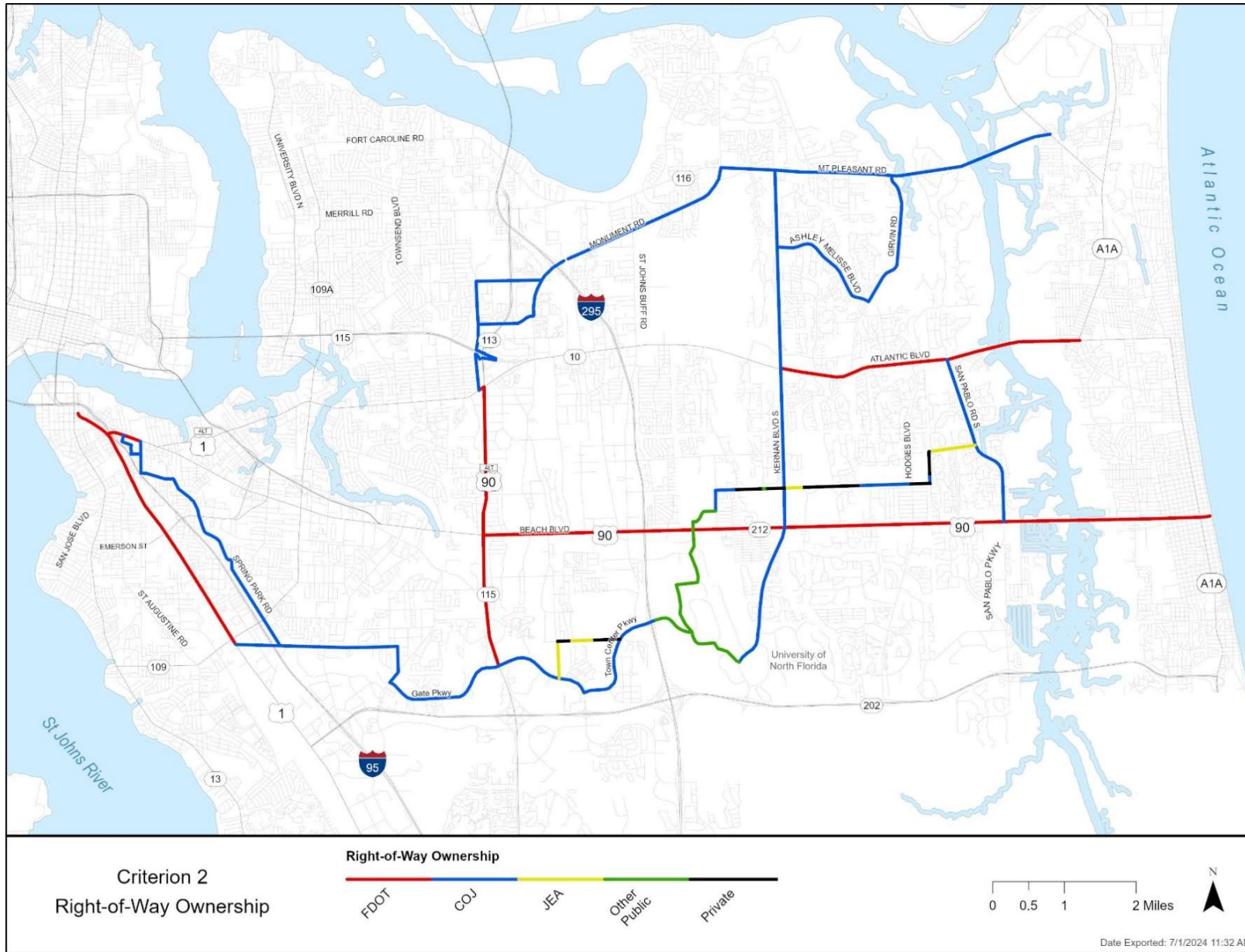

Figure 11 - Right-of-Way Ownership

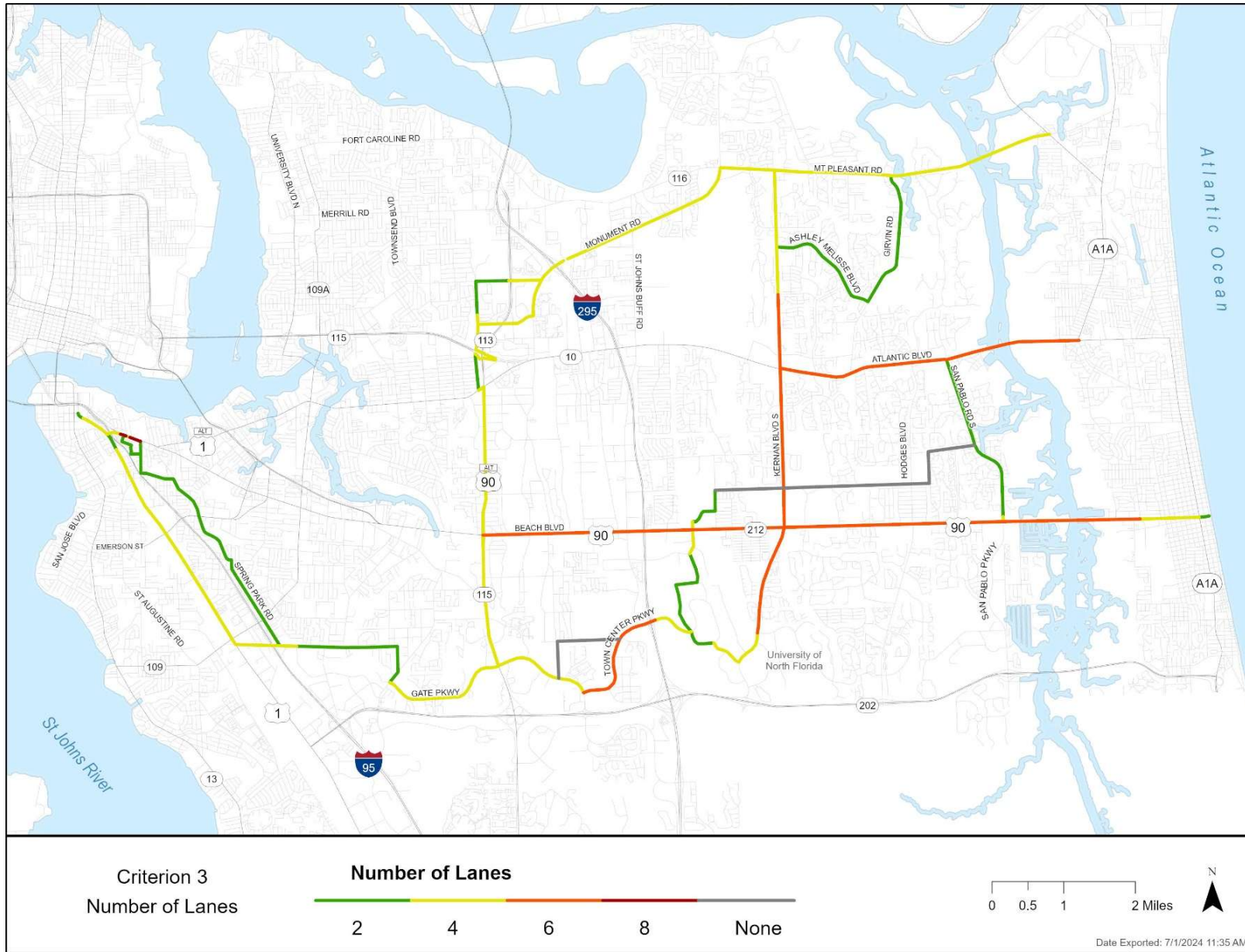
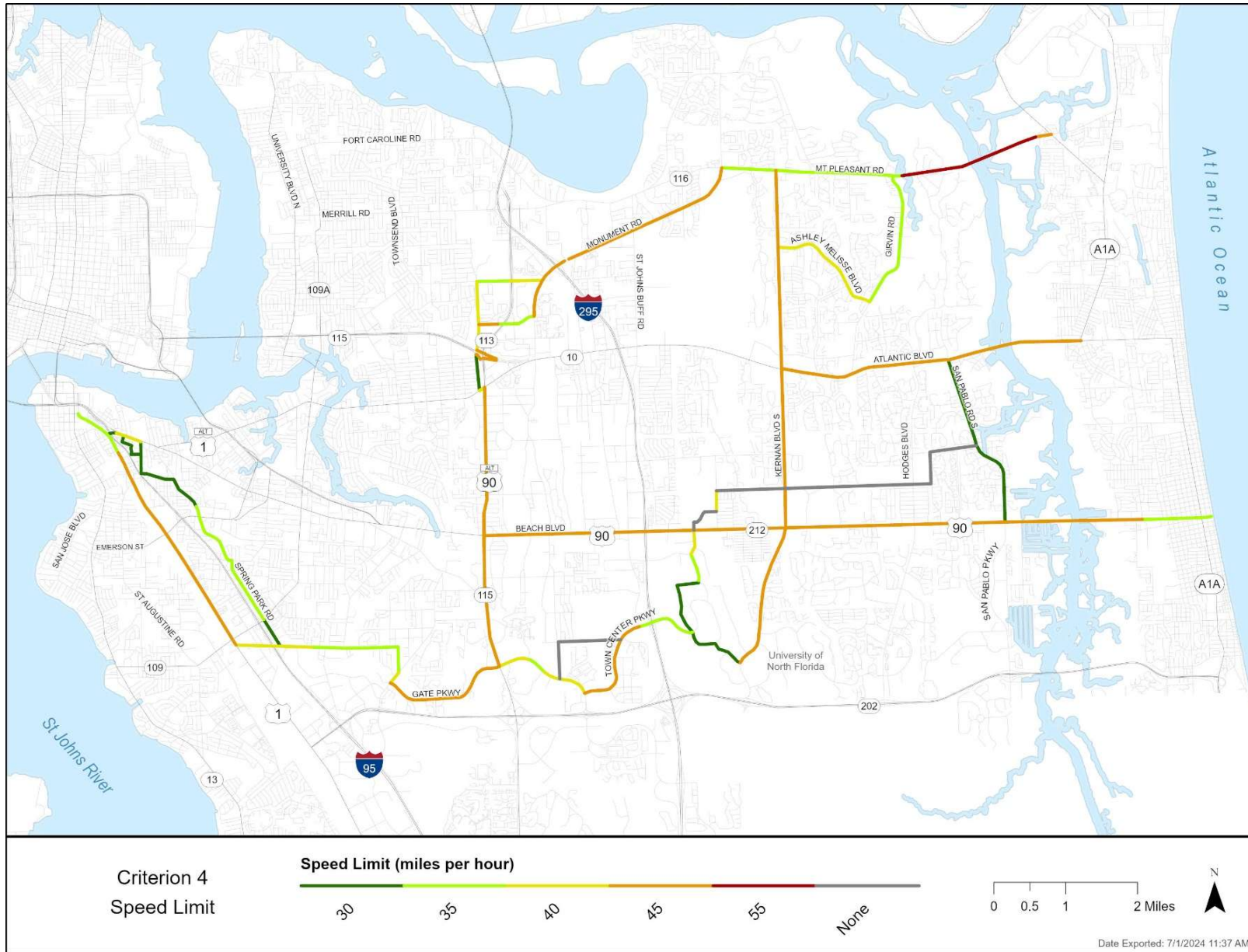
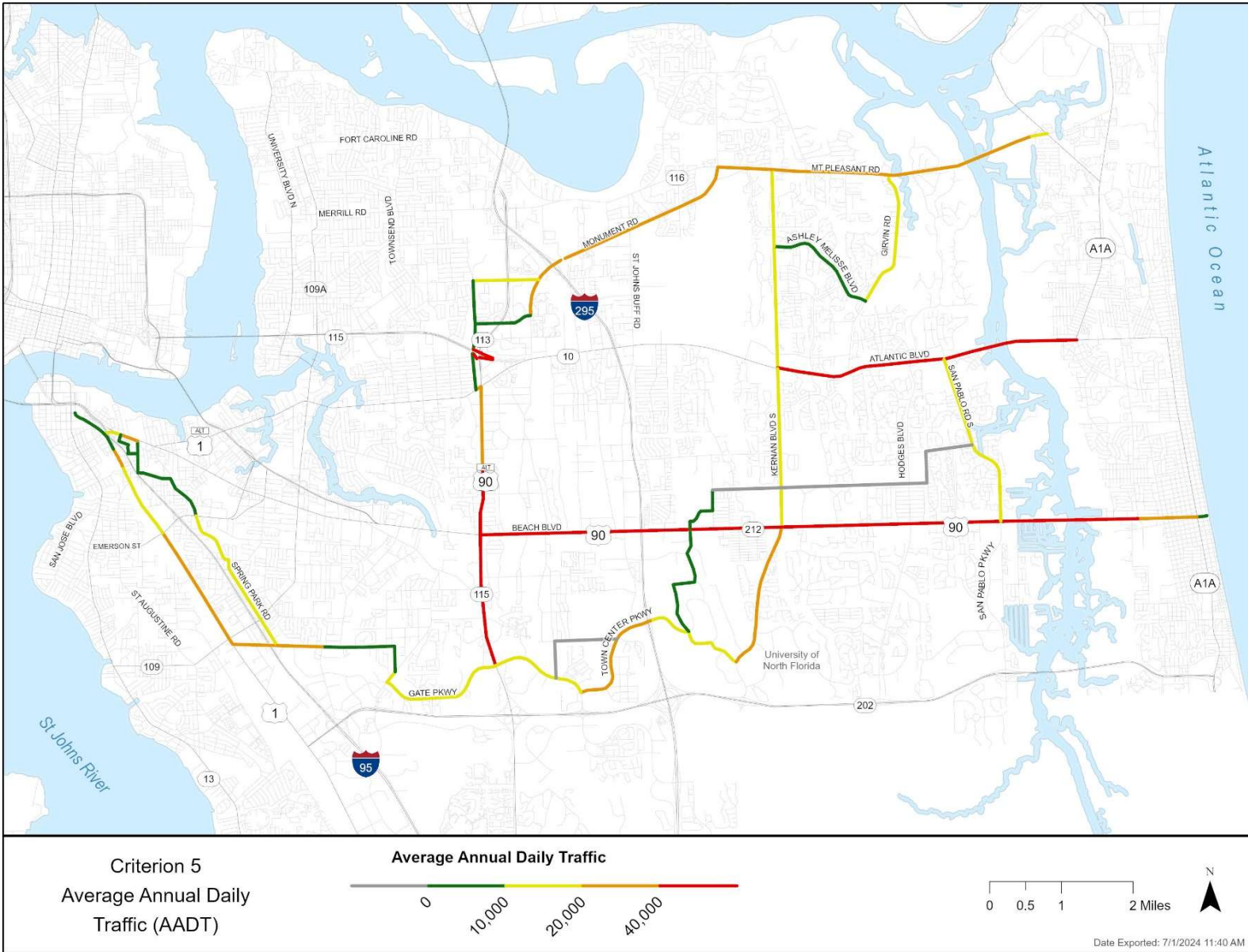

Figure 12 – Number of Lanes



**Figure 13 - Posted Speed Limit**



**Figure 14 - Average Annual Daily Traffic**



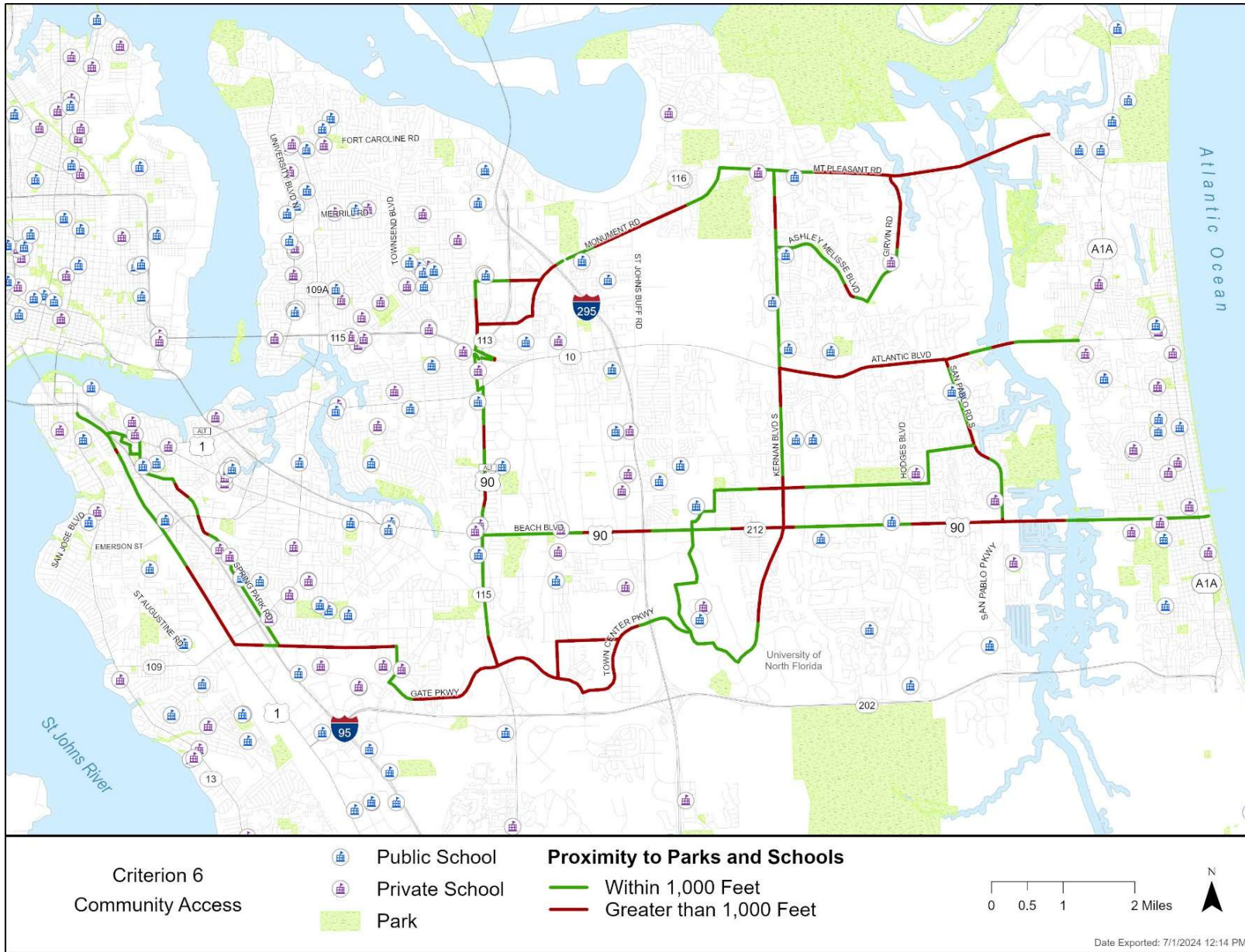
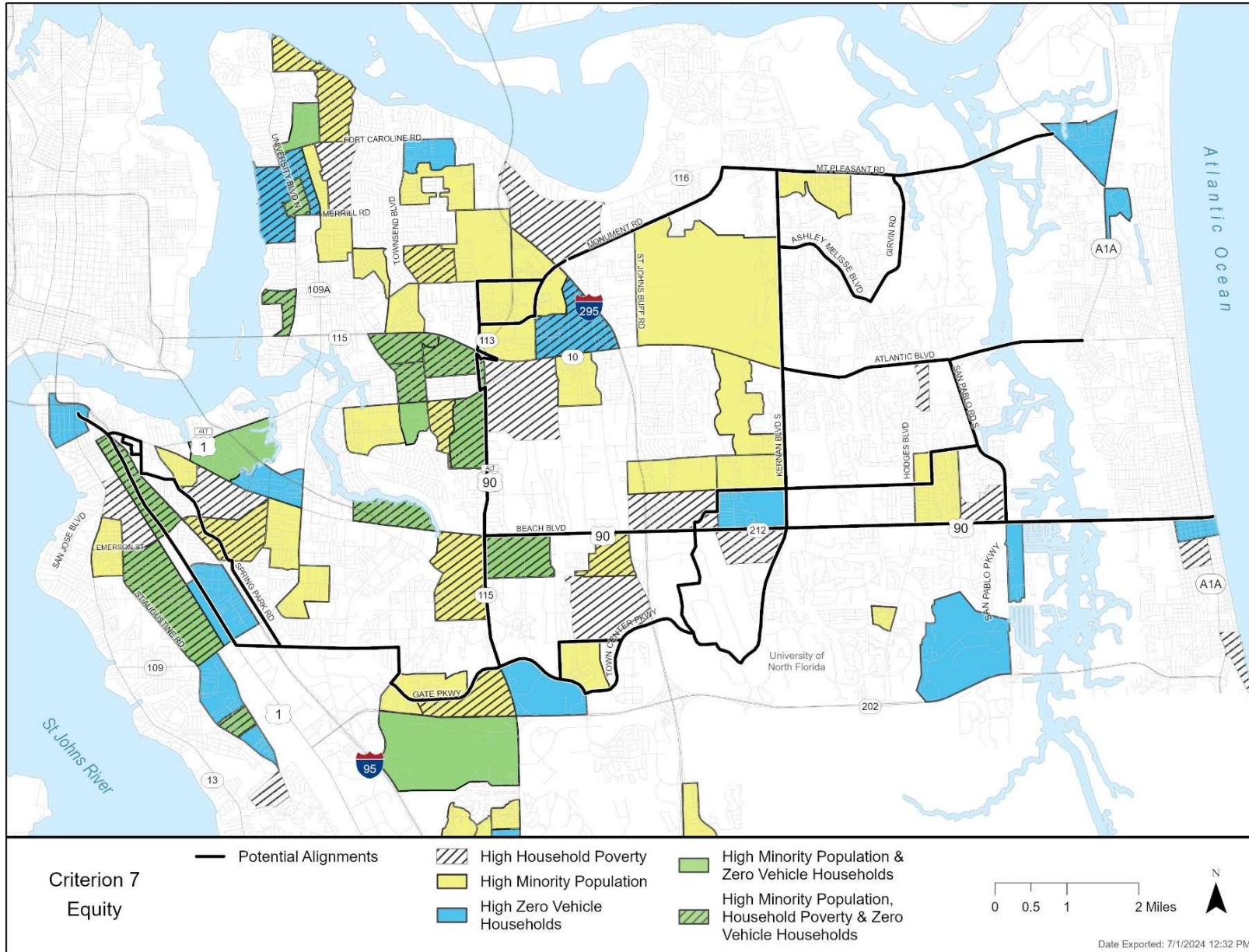
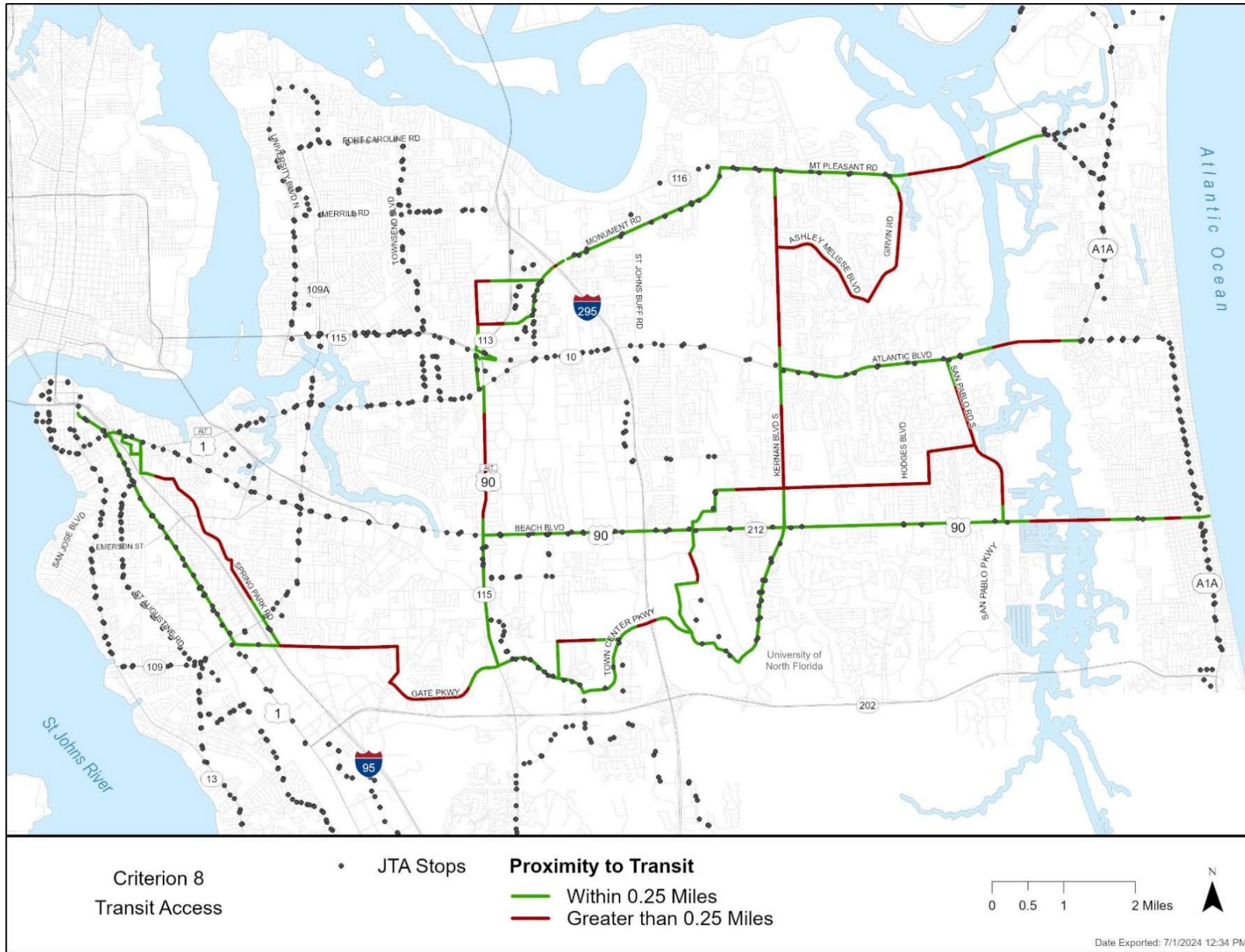
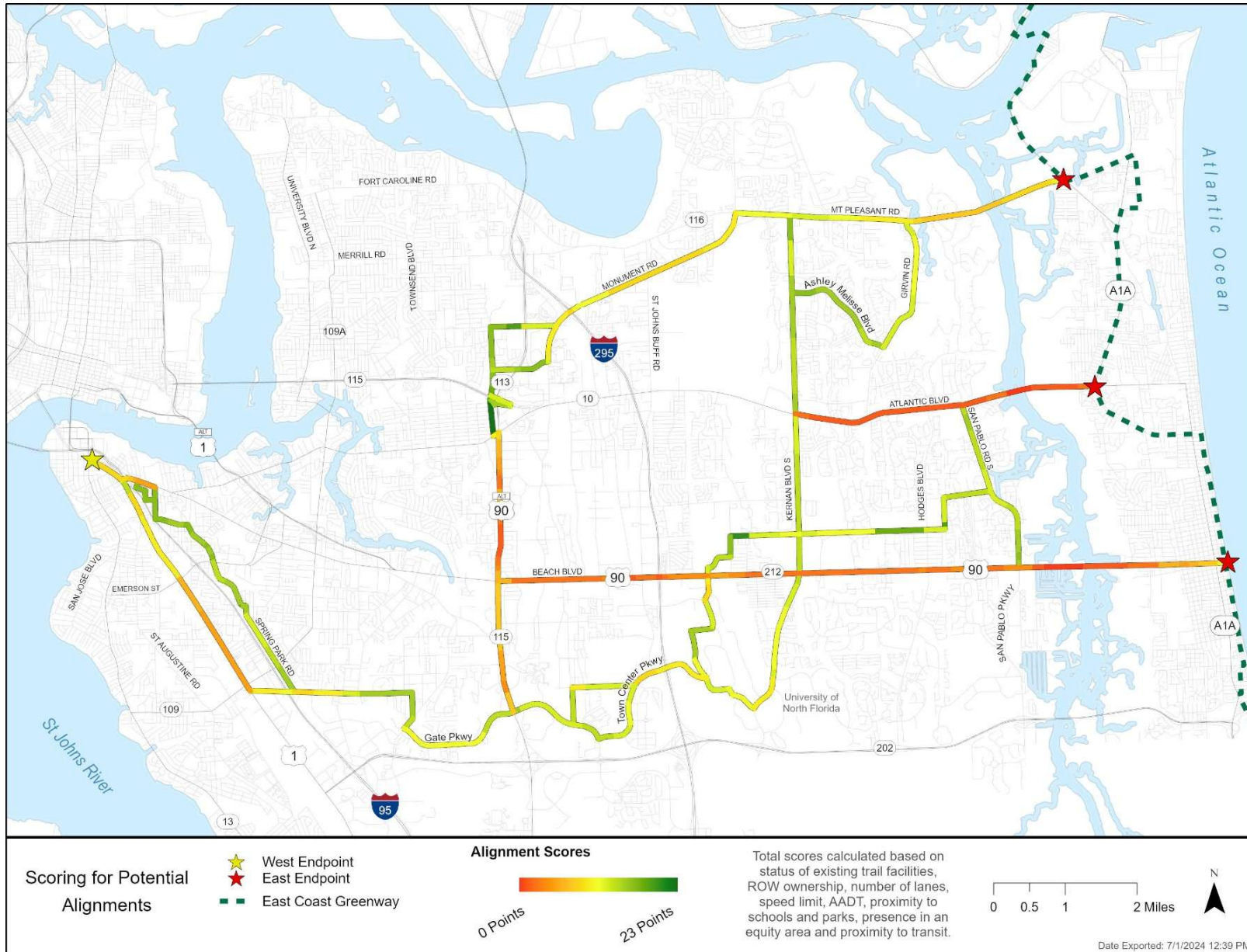

Figure 15 - Community Access



**Figure 16 – Equity**





**Figure 18 – Total Evaluation Scores**

## 5.2 RECOMMENDED ALIGNMENT

This Alignment Feasibility Study represents the first step in this multi-year, multi-phase project. Final alignment and cross section of the Core-2-Coast Trail is dependent on an engineering implementation study which includes survey, utility coordination, ROW determination and permitting. The City must also coordinate the alignment with FDOT, JTA, JEA and adjacent residents, businesses and property owners.

Figure 19 depicts the recommended (highest scoring) alignment for the Core-2-Coast Trail. The alignment utilizes existing and proposed paths, with gaps connected by new construction, road diets and/or widening existing sidewalks to a SUP. Proposed typical sections are provided in Appendix I and depict alterations to the existing infrastructure. The preferred width of the trail is 10-12 LF, although in some sections the path may be reduced to as little as 8 LF to accommodate the path within existing ROW without relocating concrete utility poles or burying utilities underground.

Benesch identified 35 distinct trail segments which are further grouped into seven links for potential construction phasing, as described in Table 4. The trail is envisioned primarily as a SUP, with short ROW constrained segments as either a cycle track or sharrows on low traffic residential streets. Highlights and areas of note are described below. The total length of the trail is approximately 25 miles.

On the west, the trail begins at the intersection of Nira Street and Kings Avenue. The SUP follows Kings Avenue and Atlantic Boulevard to Stevens Street in St. Nicholas. Users share the road through the residential neighborhood along Stevens Street, Bertha Street, Flesher Avenue, through historic Jerusalem Cemetery and Graham Avenue to reach White Avenue and San Diego Road.

Oakland Cemetery in Tallahassee, FL is a relevant example of the respectful colocation of a trail with a cemetery. Another example is Oakland Cemetery in Atlanta, GA. Located near the BeltLine network of

multi-use trails, riders are encouraged to peddle through what is considered Atlanta’s oldest green space. For the Core-2-Coast Trail, the City must coordinate the alignment with Jerusalem Baptist Church and area residents. If this option is not viewed favorably, a higher stress alternative for the segment is an 8-LF sidewalk paralleling S.R. 10 (Atlantic Boulevard) between Stevens Street and White Avenue.

Moving farther south, the Spring Park Road segment between San Diego Road and Emerson Street uses lane reallocation to eliminate existing on-street bike lanes and provide a 12-LF cycle track with modular traffic separator (e.g. zicla zipper system). Until funding is available, the existing bike lanes on Spring Park Road can serve as a temporary Core-2-Coast Trail connection.



*Signage reminds bicyclists to respectfully follow the designated route through Oakland Cemetery in Tallahassee, FL.*

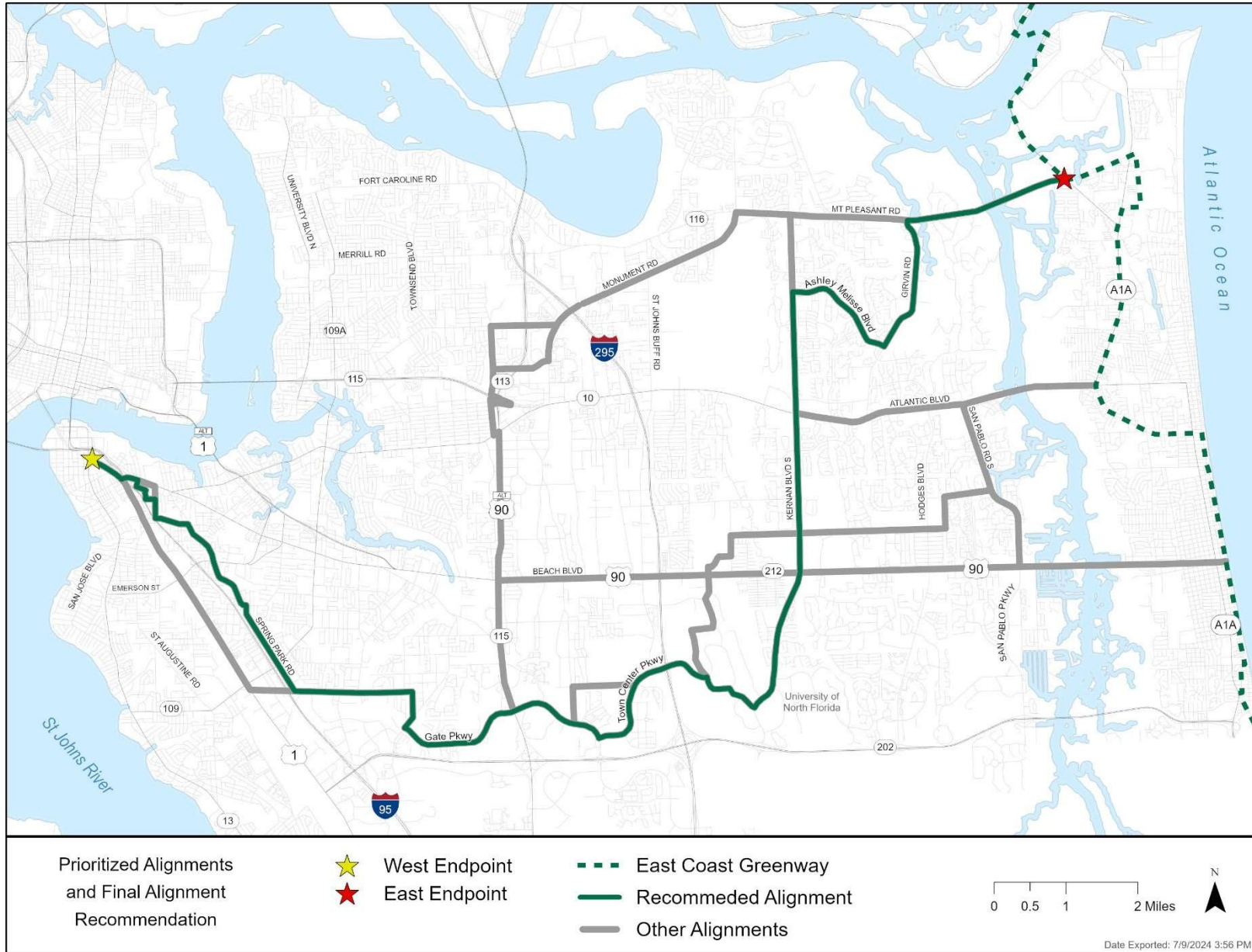

**Figure 19 – Recommended Alignment**

**Table 4 – Status of Multimodal Facilities Along Recommended Alignment**

Link	Segment	Road Name	Begin	End	Type	Location (Side of Road)	Status	Length (Mi.)	Nearby Community Facilities
1	1	Kings Avenue	Nira Street	S.R. 10 (Atlantic Boulevard)	Cycle Track	East	New	0.51	Southside Park Historic Kings Road Park
2	2	S.R. 10 (Atlantic Boulevard)	Kings Avenue	Stevens St	Shared Use Path	South	New	0.24	Assumption Catholic Church and School Bishop Kenny High School
3	3	Stevens Street	S.R. 10 (Atlantic Boulevard)	Bertha St	Sharrow	-	-	4.1	American Legion Post 88 Children’s Home Society of Florida Douglas Anderson School of the Arts Englewood Elementary School Englewood High School Hardage-Giddens Greenlawn Funeral Home & Cemetery Jerusalem Baptist Cemetery Pine Castle Inc. and Residential House Spring Park Elementary School University Christian School
	4	Bertha Street	Stevens Street	Flesher Avenue	Sharrow	-	-		
	5	Jerusalem Baptist Cemetery	Flesher Avenue	Graham Avenue	Sharrow	-	-		
	6	Graham Avenue	Jerusalem Baptist Cemetery	White Avenue	Sharrow	-	-		
	7	White Avenue	Graham Avenue	San Diego Road	Shared Use Path	East	New		
	8	San Diego Road	White Avenue	Spring Park Road	Shared Use Path	North	New		
	9	Spring Park Road	San Diego Road	Emerson St	Cycle Track	West	New		
	10	Spring Park Road	Emerson St	Spring Glen Road	Shared Use Path	West	New		
	11	Spring Glen Road	Spring Park Road	Spring Park Road	Shared Use Path	South	New		
	12	Spring Park Road	Spring Glen Road	University Boulevard	Shared Use Path	East	New		
4	13	Spring Park Road	University Boulevard	Bowden Road	Shared Use Path	East	New	2.2	Brooks Rehab Home Health Daniel Memorial/Daniel Kids Early Learning Coalition of Duval
	14	Bowden Road	Spring Park Road	Southpoint Parkway	Shared Use Path	North	New		
	15	Bowden Road	Southpoint Parkway	Parental Home Road	Shared Use Path	North	Funded		
	16	Bowden Road	Parental Home Road	Tiger Hole Road	Shared Use Path	North	Funded		
	17	Bowden Road	Tiger Hole Road	Bowden Road S	Shared Use Path	North	New		
	18	Bowden Road	Bowden Road	Belfort Road	Shared Use Path	East	New		
5	19	Belfort Road	Bowden Road S	Gate Parkway W	Shared Use Path	East	New	4.8	Ascension St. Vincent’s Hospital FL Blue Campus Merrill Lynch Campus St. Johns Town Center
	20	Gate Parkway W	Belfort Road	S.R. 115 (Southside Boulevard)	Shared Use Path	South	New		
	21	Gate Parkway	S.R. 115 (Southside Boulevard)	Town Center Parkway	Shared Use Path	South	New		
	22	Town Center Parkway	Gate Parkway	Brightman Boulevard	Shared Use Path	North	Existing		
6	23	Town Center Parkway	Brightman Boulevard	UNF Drive	Shared Use Path	North	New	1.9	University of North FL Campus, Student Housing and Nature Trails
	24	UNF Drive	Town Center Parkway	UNF Drive	Shared Use Path	Both	Funded		
	25	UNF Drive South Loop	UNF Drive	Alumni Drive	Shared Use Path	North	Funded		
	26	Alumni Drive	UNF Drive South Loop	Kernan Boulevard	Shared Use Path	South	Funded		
	27	Kernan Boulevard S	Alumni Dr	First Coast Tech Parkway	Shared Use Path	East	New		

Link	Segment	Road Name	Begin	End	Type	Location (Side of Road)	Status	Length (Mi.)	Nearby Community Facilities
7	28	Kernan Boulevard	First Coast Tech Parkway	Ashley Melisse Boulevard	Shared Use Path	East	Existing	11.5	Anchor Academy Elementary School Kathryn Abbey Hanna Park Kernan Middle School Kernan Trail Elementary School JTA Park-n-Ride Landmark Middle School Pablo Mayport Cemetery Sabal Palm Elementary School Seaside Community Charter School Waterleaf Elementary School
	29	Ashley Melisse Boulevard	Kernan Boulevard	Girvin Road	Shared Use Path	South	New		
	30	Girvin Road	Ashley Melisse Boulevard	S.R. 116 (Wonderwood Drive)	Shared Use Path	West	New		
	31	S.R. 116 (Wonderwood Drive)	Girvin Road	Mt. Pleasant Creek Bridge	Shared Use Path	North	New		
	32	Mt. Pleasant Creek Bridge	S.R. 116 (Wonderwood Drive)	S.R. 116 (Wonderwood Drive)	Shared Use Path	North	Existing		
	33	S.R. 116 (Wonderwood Drive)	Mt. Pleasant Creek Bridge	Intracoastal Waterway Bridge	Shared Use Path	North	New		
	34	Intracoastal Waterway Bridge	S.R. 116 (Wonderwood Drive)	S.R. 116 (Wonderwood Drive)	Shared Use Path	North	Existing		
	35	S.R. 116 (Wonderwood Drive)	Intracoastal Waterway Bridge	S.R. A1A	Shared Use Path	North	New		



The Belfort Road segment (Bowden Road South to Gate Parkway West) replaces the existing 5-LF sidewalk on the east side of road with a 10-LF SUP. It may be possible to incorporate this into the ongoing widening design of Belfort Road (Project ID 001333). The existing Pottsburg Creek bridge is a pinch point and may require a separate pedestrian structure to accommodate the SUP.

As indicated in the adjacent image, a JEA utility easement may provide an opportunity to bypass a segment between Gate Parkway and Town Center Parkway, if agreement can be reached between COJ and private property owners.

Just east of Brightman Boulevard on Town Center Parkway, multimodal accommodations on the bridge over Pablo Creek consist only of key hole bike lanes and an unprotected sidewalk. A pedestrian structure over Pablo Creek may be needed to address this constraint and accommodate a SUP.

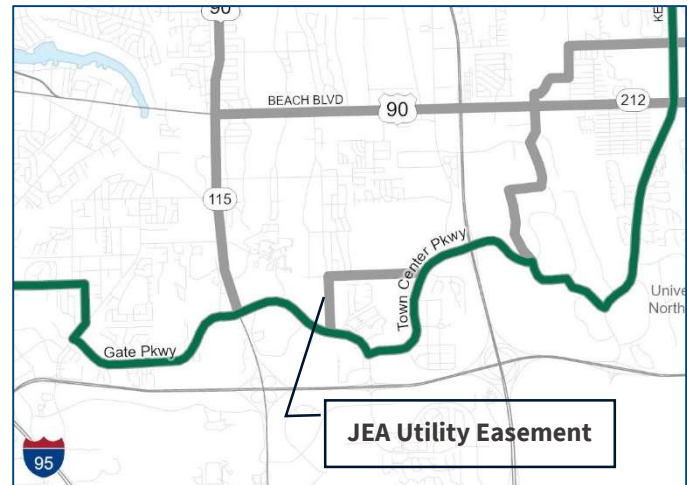

*Coordinate with JEA and private property owners to potentially use the utility easement as part of the Core-2-Coast Trail.*

East of I-295, a funded 12-LF SUP on the south side of UNF Drive and Alumni Drive provides connection between St. Johns Town Center, the UNF campus and Kernan Boulevard. An unfunded (inactive) Better Jacksonville Plan (BJP)/JTA Mobility Works (Kernan Boulevard Phase 6) project on Kernan Boulevard may fill the multimodal gap between S.R. 202 (J. Turner Butler Boulevard (JTB)) and Glen Kernan Parkway by replacing the existing sidewalk with a 12-LF SUP. Once constructed, there will be a continuous trail from south of S.R. 202 (JTB) to S.R. 116 (McCormick Road).

From the north end of Kernan Boulevard, the Core-2-Coast Trail alignment continues east on Ashley Melisse Boulevard where the existing sidewalk on the south side of the road can be widened to 10 LF. Girvin Road, between Ashley Melisse Boulevard and S.R. 116 (Wonderwood Drive), is a constrained section but an 8 LF SUP can be implemented by widening the sidewalk on the west side. The SUP crosses the Intracoastal Waterway via an 8 LF pedestrian corridor on the north side of the S.R. 116 (Wonder Expressway) bridge. The SUP then continues on S.R. 116 (Wonderwood Drive) to S.R. A1A and the East Coast Trail alignment.

### 5.3 COST ESTIMATE

***Benesch grouped the 35 segments along the preferred alignment into seven overall links, which are depicted in Figure 20. Figure 20 – Core-2-Coast Trail Links***

Table 5 provides a concept level construction cost estimate by link. The overall project is estimated to cost approximately \$25 million. The cost estimate is provided in Appendix I.

Pay item costs are based on the FDOT 12 Month Moving Market Area Averages (10/01/2023 through 09/30/2024) and the Cost per Mile Model for a Two Directional, 12' Shared Use Path. The cost estimate is based on the concept plan and is for planning purposes only. The estimate may be revised

following additional evaluation, engineering feasibility and design. The cost estimate does not include additional evaluation, engineering feasibility, ROW acquisition, utility relocation or design. Also, environmental permitting is not included and should be added once design is underway.



*Looking west along the S.R. 116 (Wonderwood Drive) bridge Waterway, which includes an 8-LF shared use path.*

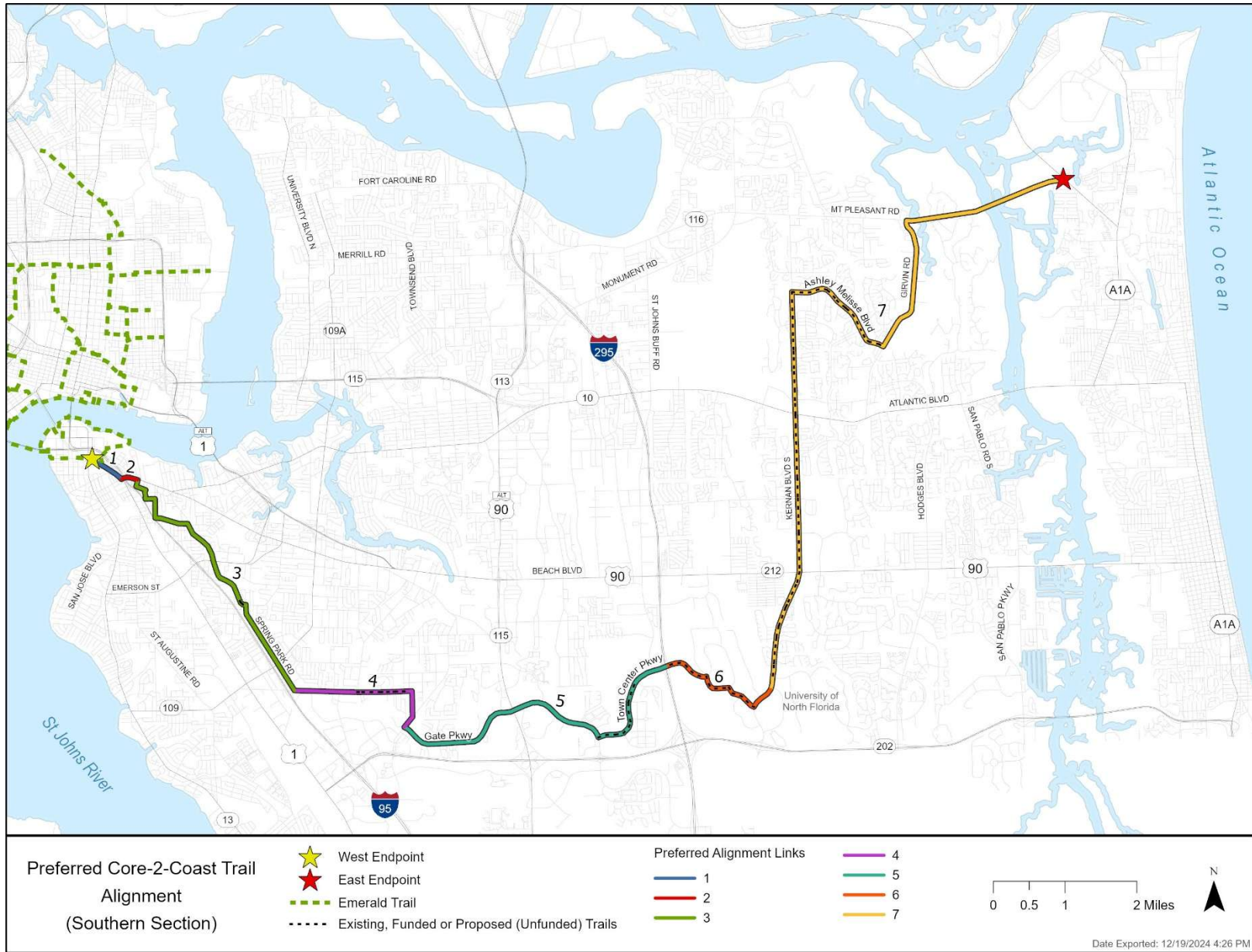

**Figure 20 – Core-2-Coast Trail Links**

**Table 5 – Construction Cost Estimate<sup>1</sup>**

Component	Factor (%)	Link 1	Link 2	Link 3	Link 4 <sup>4</sup>	Link 5	Link 6 <sup>4</sup>	Link 7	Total
C-2-C Trail		\$523,903	\$136,471	\$4,750,573	\$1,189,040	\$4,071,123	\$370,027	\$3,837,275	\$14,878,412
Mobilization	10%	\$52,390	\$13,647	\$475,057	\$118,904	\$407,112	\$37,003	\$383,727	\$1,487,841
MOT	10%	\$52,390	\$13,647	\$475,057	\$118,904	\$407,112	\$37,003	\$383,727	\$1,487,841
<b>Construction Subtotal</b>		<b>\$628,683</b>	<b>\$163,765</b>	<b>\$5,700,688</b>	<b>\$1,426,848</b>	<b>\$4,885,348</b>	<b>\$444,033</b>	<b>\$4,604,730</b>	<b>\$17,854,094</b>
Contingency	10%	\$62,868	\$16,377	\$570,069	\$142,685	\$488,535	\$44,403	\$460,473	\$1,785,409
<b>Construction Total</b>		<b>\$691,552</b>	<b>\$180,142</b>	<b>\$6,270,756</b>	<b>\$1,569,533</b>	<b>\$5,373,883</b>	<b>\$488,436</b>	<b>\$5,065,203</b>	<b>\$19,639,504</b>
CEI	15%	\$94,303	\$24,565	\$855,103	\$214,027	\$732,802	\$66,605	\$690,709	\$2,678,114
PE	15%	\$94,303	\$24,565	\$855,103	\$214,027	\$732,802	\$66,605	\$690,709	\$2,678,114
Environmental Permitting <sup>3</sup>		-	-	-	-	-	-	-	-
<b>Subtotal</b>		<b>\$188,605</b>	<b>\$49,130</b>	<b>\$1,710,206</b>	<b>\$428,054</b>	<b>\$1,465,604</b>	<b>\$133,210</b>	<b>\$1,381,419</b>	<b>\$5,356,228</b>
<b>PROJECT TOTAL</b>		<b>\$880,157</b>	<b>\$229,271</b>	<b>\$7,980,963</b>	<b>\$1,197,587</b>	<b>\$6,839,487</b>	<b>\$621,646</b>	<b>\$6,446,621</b>	<b>\$24,995,732</b>

<sup>1</sup> Slight variations in totals due to rounding

<sup>2</sup> FDOT Area 5 (Duval County) 12-Month Moving Market Area Averages (10/1/2023 – 9/30/2024)

<sup>3</sup> Environmental permitting is not included and should be considered once design is underway

<sup>4</sup> Funded segments not included

## 6 NEXT STEPS

The Core-2-Coast Trail represents an exciting opportunity to provide regional connectivity and expand bicycle and pedestrian access across the City. The alignment study lays the groundwork and recommendations for next steps, listed below, are intended to assist the City to continue progress and prioritize future efforts.

- Work with City Council representatives, Mayor’s Office and Public Works to prioritize trail gaps in the Capital Improvements Plan (CIP).
- Coordinate internally between JPDD and Public Works to implement recommendations in resurfacing or maintenance projects as well as upcoming capital projects.
- Coordinate with City Council members on trail alignment through individual districts. Council members are key allies to raise awareness of the trail, establish funding and cultivate support of residents and businesses.
- Coordinate with members of Jerusalem Baptist Church regarding public trail access through Jerusalem Cemetery. Meetings and correspondence should include the District 5 and At Large City Councilpersons.
- Work with JEA for opportunities to utilize utility easements for trail connections, facilities, parking, etc.
- Coordinate with FDOT District 2 where the trail meets state roadways, such as Atlantic Boulevard in St. Nicholas and on the S.R. 116 (Wonderwood Expressway) Bridge. On the bridge, there may be an opportunity to reallocate the lanes and move the concrete barrier to create a wider path, similar to what was accomplished in District 5 on the US 17/92 bridge over the St. Johns River near Sanford.
- Connect with JTA and FDOT regarding the trail alignment and road diet along Kings Road.
- Utilize the Alignment Feasibility Study in tandem with the Smart Surfaces Coalition study to lay the groundwork for Federal funding (e.g. RAISE grants) for the complete trail system.
- Investigate opportunities with FDOT and other state agencies for funding for trail segments. These include SUN Trail, Transportation Alternatives Program (TAP) and Recreational Trails Program (Florida Department of Environmental Protection).



*A paved drive winds through Jerusalem Cemetery in the St. Nicholas area of Jacksonville.*

This Alignment Feasibility Study represents the first step in this multi-year, multi-phase project. Final alignment and cross section of the Core-2-Coast Trail is dependent on an engineering implementation study which includes survey, utility coordination, ROW determination and permitting. The City must also seek funding sources and conduct community outreach and multiagency coordination to confirm the route.

# APPENDIX A

## Field Review Photographs



Kings Road



Kings Road

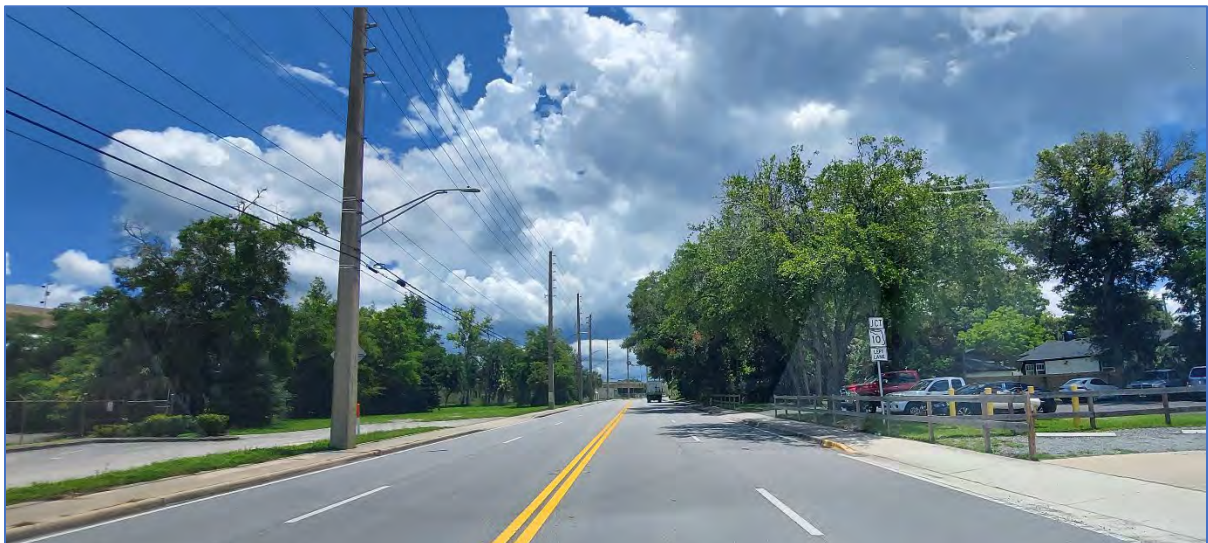

Kings Road



Jerusalem Cemetery



Jerusalem Cemetery



White Street





White Street



San Diego Road



Spring Park Road, north of Emerson Street



Spring Park Road, south of Emerson Street



Spring Park Road, south of Emerson Street



Bowden Road



Bowden Road



Bowden Road



Bowden Road



Bowden Road, north of Belfort Road



Bowden Road



Gate Parkway, east of Southside Boulevard



Gate Parkway, north of Town Center Parkway



Gate Parkway, north of Town Center Parkway



Town Center Parkway



Town Center Parkway



Town Center Parkway



Town Center Parkway



Town Center Parkway



Town Center Parkway



Town Center Parkway



UNF/Alumni Drive



UNF/Alumni Drive



Kernan Boulevard





Kernan Boulevard



Kernan Boulevard



Kernan Boulevard



Kernan Boulevard



Kernan Boulevard

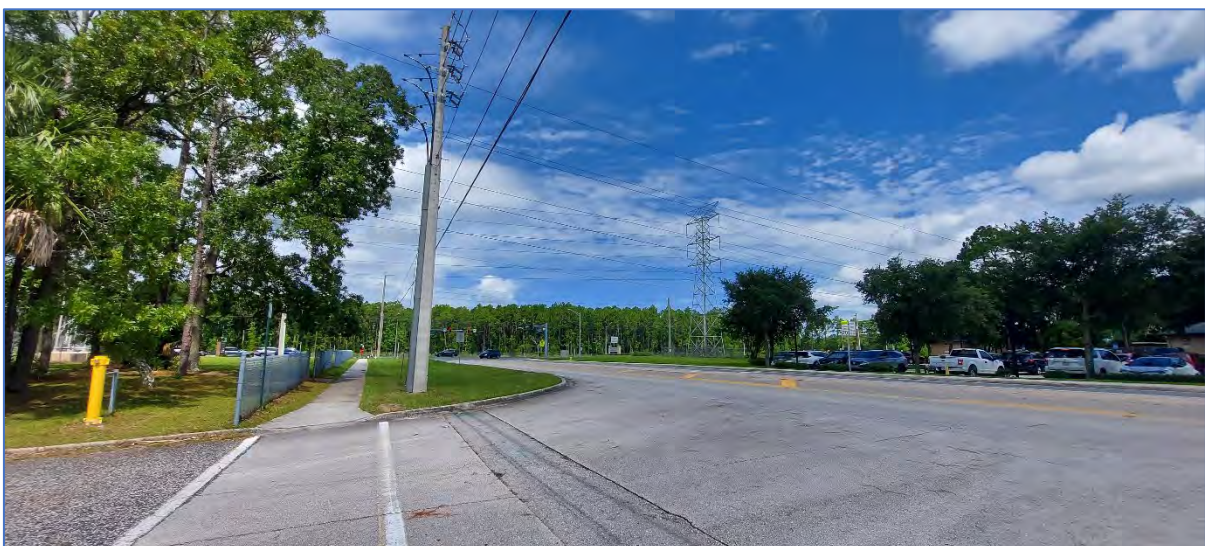

Ashley Melisse Boulevard



Asheley Melisse Boulevard



Asheley Melisse Boulevard



Asheley Melisse Boulevard



Girvin Road



Girvin Road



S.R. 116 (Wonderwood Expressway)



S.R. 116 (Wonderwood Expressway)



S.R. 116 (Wonderwood Drive)



S.R. 116 (Wonderwood Drive)



S.R. 116 (Wonderwood Expressway)



S.R. 116 (Wonderwood Expressway)



S.R. 116 (Wonderwood Expressway)



S.R. 116 (Wonderwood Expressway)



S.R. 116 (Wonderwood Expressway)



S.R. 116 (Wonderwood Drive)



S.R. 116 (Wonderwood Drive), between Girvin Road and Kernan Boulevard



# APPENDIX B

## Existing Typical Sections

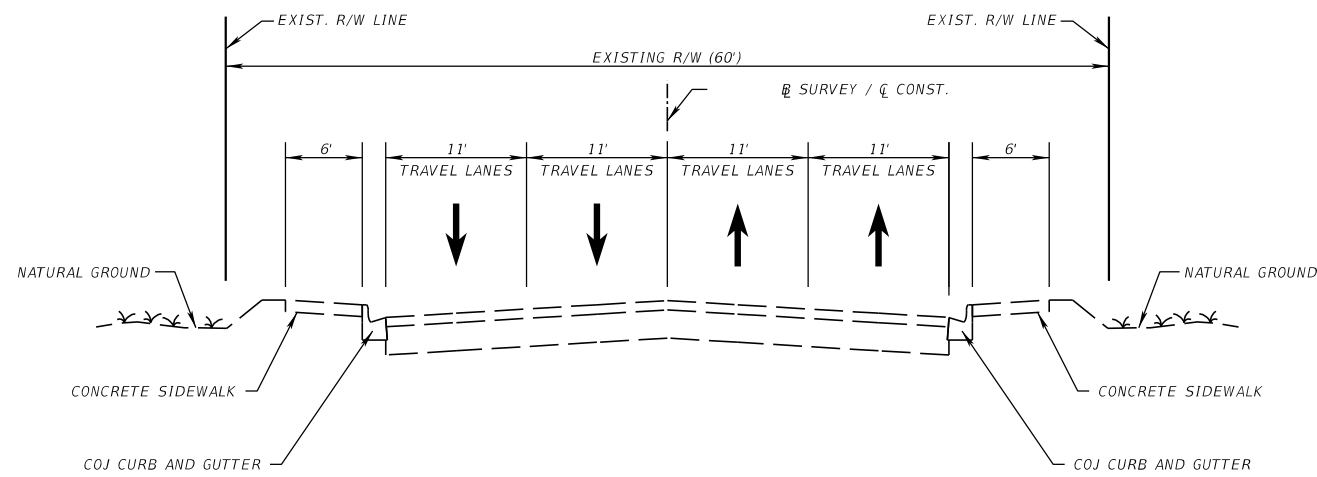

TYPICAL SECTION  
 KINGS AVE  
 (NIRA ST TO ATLANTIC BLVD)

7/19/2024 10:42:30 AM cmushi C:\Users\cmushi\Documents\Benesch\C2C Typical Sections\Microstation\Existing\TYPSTRD01.dgn

THE OFFICIAL RECORD OF THIS SHEET IS THE ELECTRONIC FILE DIGITALLY SIGNED AND SEALED UNDER RULE 61G15-23.004, F.A.C.

REVISIONS				ENGINEER OF RECORD			EXISTING TYPICAL SECTION	SEGMENT NO.
DATE	DESCRIPTION	DATE	DESCRIPTION	ROAD NO.	COUNTY	FINANCIAL PROJECT ID		1
				VARIES	DUVAL	N/A		

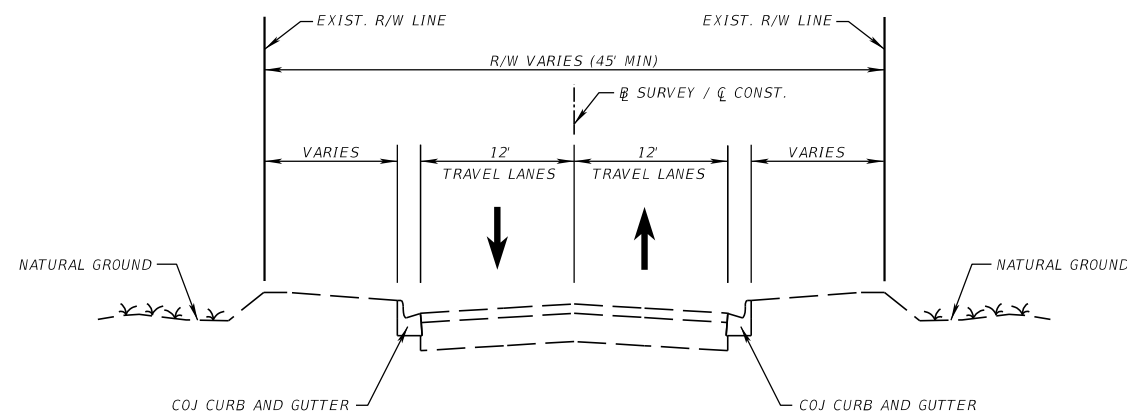

TYPICAL SECTION  
 STEVENS ST  
 (ATLANTIC BLVD. TO BERTHA ST)

7/19/2024 10:49:33 AM cmushi  
 C:\Users\cmushi\Documents\Benesch\C2C Typical Sections\Microstation\Existing\TYPSTRD01.dgn

REVISIONS				ENGINEER OF RECORD			EXISTING TYPICAL SECTION	SEGMENT NO.
DATE	DESCRIPTION	DATE	DESCRIPTION	ROAD NO.	COUNTY	FINANCIAL PROJECT ID		3
				VARIES	DUVAL	N/A		

THE OFFICIAL RECORD OF THIS SHEET IS THE ELECTRONIC FILE DIGITALLY SIGNED AND SEALED UNDER RULE 61G15-23.004, F.A.C.

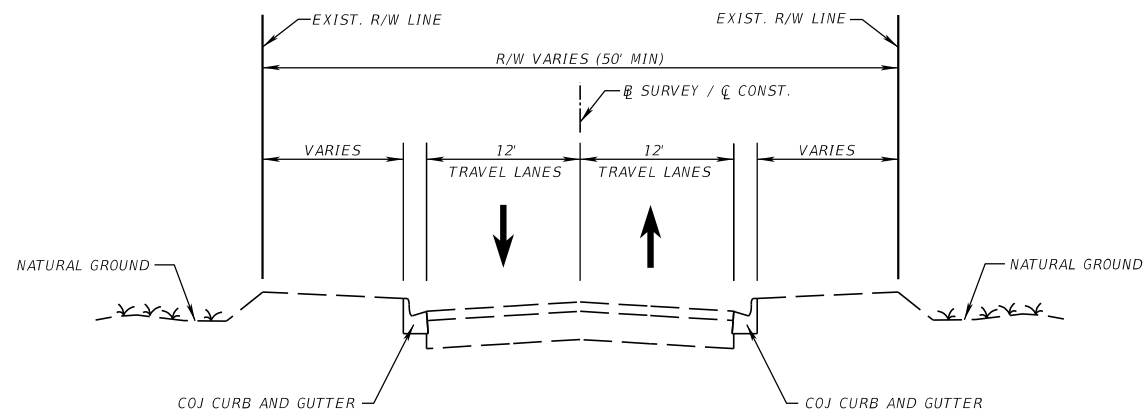

TYPICAL SECTION  
 BERTHA ST  
 (STEVENS ST. TO FLESHER AVE)

7/19/2024 10:26:25 AM cmushi C:\Users\cmushi\Documents\Benesch\C2C Typical Sections\Microstation\Existing\TYPSTRD01.dgn

REVISIONS				ENGINEER OF RECORD			EXISTING TYPICAL SECTION	SEGMENT NO.
DATE	DESCRIPTION	DATE	DESCRIPTION	ROAD NO.	COUNTY	FINANCIAL PROJECT ID		4

THE OFFICIAL RECORD OF THIS SHEET IS THE ELECTRONIC FILE DIGITALLY SIGNED AND SEALED UNDER RULE 61G15-23.004, F.A.C.

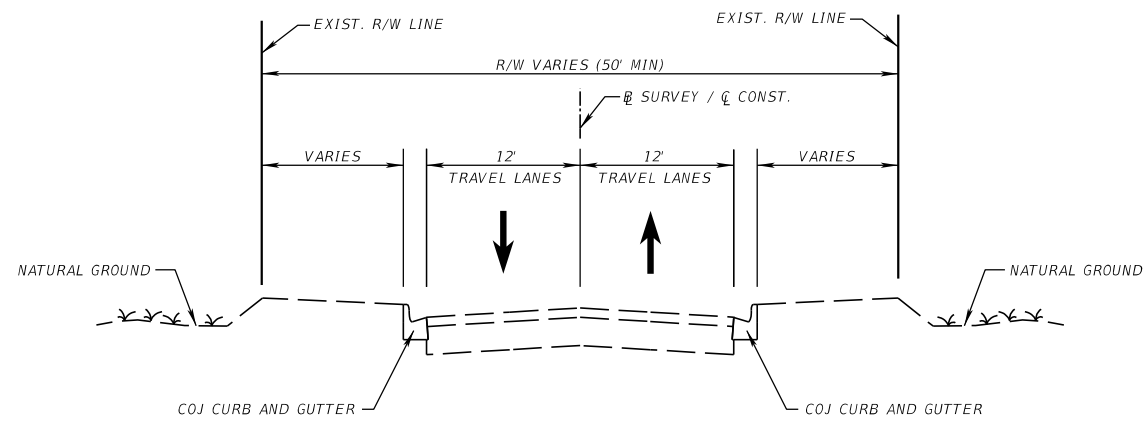

TYPICAL SECTION  
 FLESHER AVE  
 (JERUSALEM BAPTIST CEMETERY TO GRAHAM AVE)

7/19/2024 10:30:54 AM cmushi  
 C:\Users\cmushi\Documents\Benesch\C2C Typical Sections\Microstation\Existing\TYPSPAD01.dgn

REVISIONS				ENGINEER OF RECORD			EXISTING TYPICAL SECTION	SEGMENT NO.
DATE	DESCRIPTION	DATE	DESCRIPTION	ROAD NO.	COUNTY	FINANCIAL PROJECT ID		5
				VARIES	DUVAL	N/A		

THE OFFICIAL RECORD OF THIS SHEET IS THE ELECTRONIC FILE DIGITALLY SIGNED AND SEALED UNDER RULE 61G15-23.004, F.A.C.

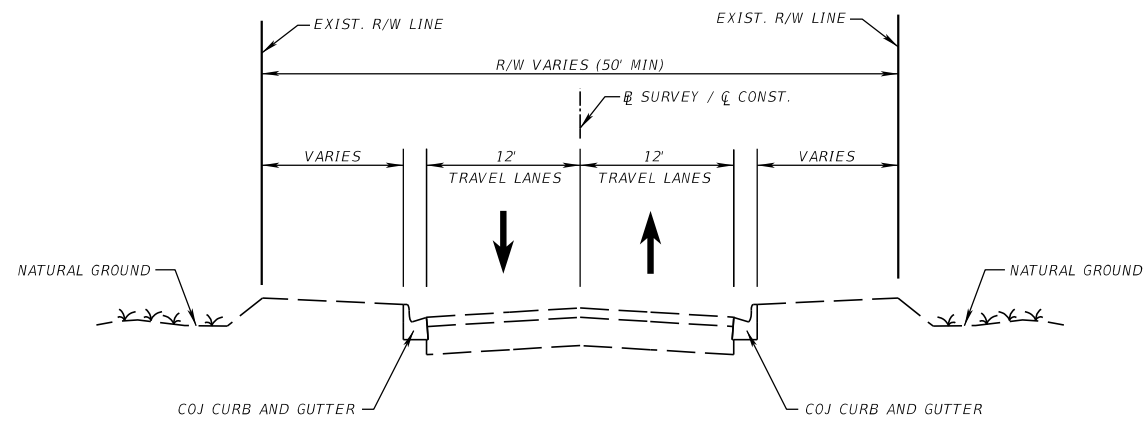

TYPICAL SECTION  
 GRAHAM AVE  
 (JERUSALEM BAPTIST CEMETERY TO WHITE AVE)

7/19/2024 10:40:07 AM cmushi C:\Users\cmushi\Documents\Benesch\C2C Typical Sections\Microstation\Existing\TYPSTRD01.dgn

THE OFFICIAL RECORD OF THIS SHEET IS THE ELECTRONIC FILE DIGITALLY SIGNED AND SEALED UNDER RULE 61G15-23.004, F.A.C.

REVISIONS				ENGINEER OF RECORD		STATE OF FLORIDA DEPARTMENT OF TRANSPORTATION			EXISTING TYPICAL SECTION	SHEET NO.
DATE	DESCRIPTION	DATE	DESCRIPTION	LICENSE NUMBER:		ROAD NO.	COUNTY	FINANCIAL PROJECT ID		6
						VARIES	DUVAL	N/A		

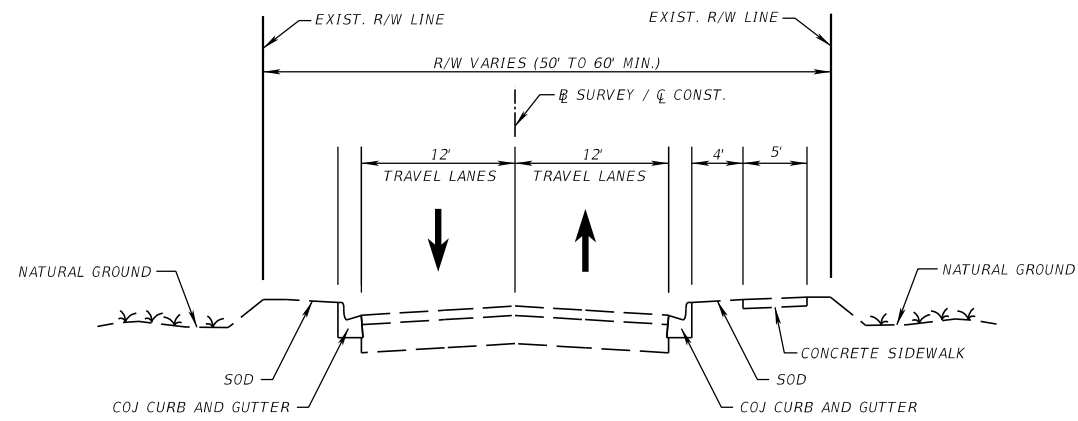

TYPICAL SECTION  
 WHITE AVE  
 (GRAHAM AVE TO SAN DIEGO RD.)

7/19/2024 10:55:04 AM cmushi C:\Users\cmushi\Documents\Benesch\C2C Typical Sections\Microstation\Existing\TYPSTRD01.dgn

REVISIONS				ENGINEER OF RECORD			EXISTING TYPICAL SECTION	SEGMENT NO:
DATE	DESCRIPTION	DATE	DESCRIPTION	ROAD NO.	COUNTY	FINANCIAL PROJECT ID		7
				VARIES	DUVAL	N/A		

THE OFFICIAL RECORD OF THIS SHEET IS THE ELECTRONIC FILE DIGITALLY SIGNED AND SEALED UNDER RULE 61G15-23.004, F.A.C.

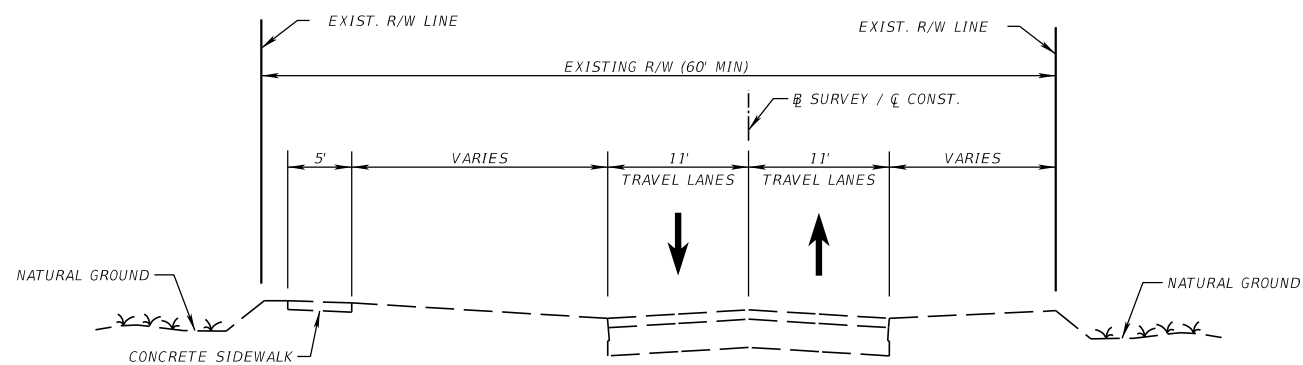

TYPICAL SECTION  
 SAN DIEGO RD  
 (WHITE AVE TO SPRING PARK RD.)

7/19/2024 10:43:01 AM cmushi C:\Users\cmushi\Documents\Benesch\C2C Typical Sections\Microstation\Existing\TYPESAD01.dgn

REVISIONS				ENGINEER OF RECORD			EXISTING TYPICAL SECTION	SEGMENT NO:
DATE	DESCRIPTION	DATE	DESCRIPTION	ROAD NO.	COUNTY	FINANCIAL PROJECT ID		8
				VARIES	DUVAL	N/A		

THE OFFICIAL RECORD OF THIS SHEET IS THE ELECTRONIC FILE DIGITALLY SIGNED AND SEALED UNDER RULE 61G15-23.004, F.A.C.



7/19/2024 10:48:57 AM cmushi  
 C:\Users\cmushi\Documents\Benesch\C2C Typical Sections\Microstation\Existing\TYPSPAD01.dgn

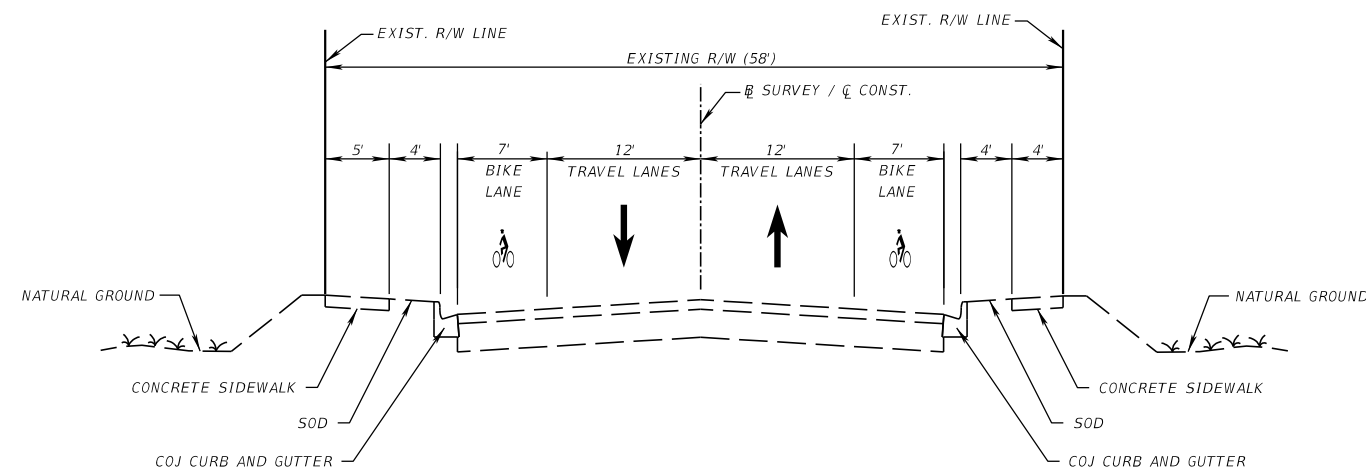

TYPICAL SECTION  
 SPRING PARK RD  
 (SAN DIEGO RD. TO EMERSON ST)

REVISIONS				ENGINEER OF RECORD			EXISTING TYPICAL SECTION	SEGMENT NO.
DATE	DESCRIPTION	DATE	DESCRIPTION	ROAD NO.	COUNTY	FINANCIAL PROJECT ID		9
				VARIES	DUVAL	N/A		

THE OFFICIAL RECORD OF THIS SHEET IS THE ELECTRONIC FILE DIGITALLY SIGNED AND SEALED UNDER RULE 61G15-23.004, F.A.C.

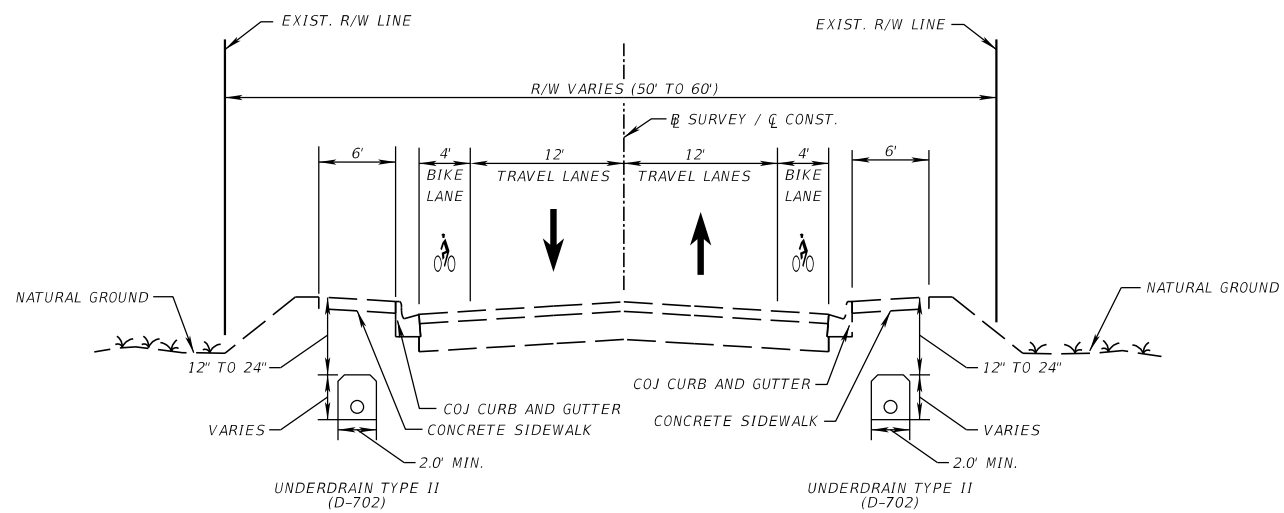

**TYPICAL SECTION  
 SPRING PARK RD.  
 (WESCH BLVD. TO SPRING GLEN RD.)  
 STA. 50+00.00 TO STA. 60+00.00  
 STA. 71+30.00 TO STA. 74+50.00  
 STA. 85+76.82 TO STA. 88+00.00  
 STA. 97+50.00 TO STA. 117+60.00**

7/19/2024 10:44:19 AM cmushi  
 C:\Users\cmushi\Documents\Benesch\C2C Typical Sections\Microstation\Existing\TYPSPRD01.dgn

REVISIONS				ENGINEER OF RECORD			EXISTING TYPICAL SECTION	SEGMENT NO.
DATE	DESCRIPTION	DATE	DESCRIPTION	ROAD NO.	COUNTY	FINANCIAL PROJECT ID		10
				VARIES	DUVAL	N/A		

THE OFFICIAL RECORD OF THIS SHEET IS THE ELECTRONIC FILE DIGITALLY SIGNED AND SEALED UNDER RULE 61G15-23.004, F.A.C.

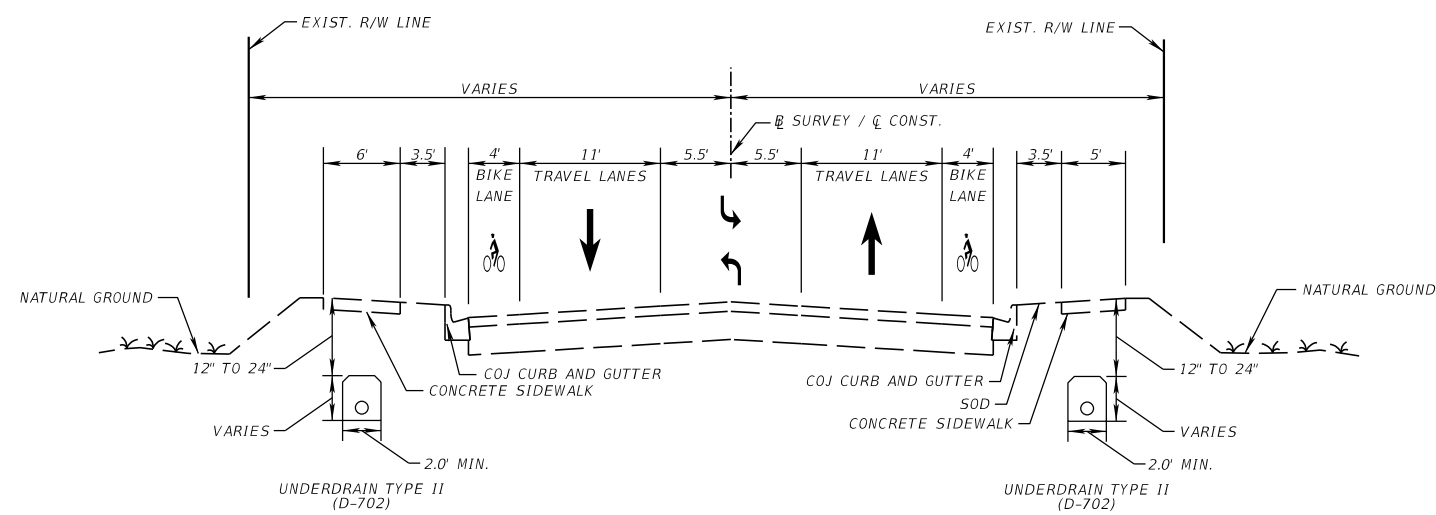

TYPICAL SECTION  
 SPRING PARK RD.  
 (SPRING GLEN RD. TO EMERSON ST.)  
 STA. 60+00.00 TO STA. 71+30.00  
 STA. 74+50.00 TO STA. 80+27.37  
 STA. 88+00.00 TO STA. 97+50.00  
 STA. 117+60.00 TO STA. 123+54.05

7/19/2024 10:47:02 AM cmushi C:\Users\cmushi\Documents\Benesch\C2C Typical Sections\Microstation\Existing\TYPSPRD01.dgn

THE OFFICIAL RECORD OF THIS SHEET IS THE ELECTRONIC FILE DIGITALLY SIGNED AND SEALED UNDER RULE 61G15-23.004, F.A.C.

REVISIONS				ENGINEER OF RECORD			EXISTING TYPICAL SECTION	SEGMENT NO.
DATE	DESCRIPTION	DATE	DESCRIPTION	ROAD NO.	COUNTY	FINANCIAL PROJECT ID		10A
				VARIES	DUVAL	N/A		

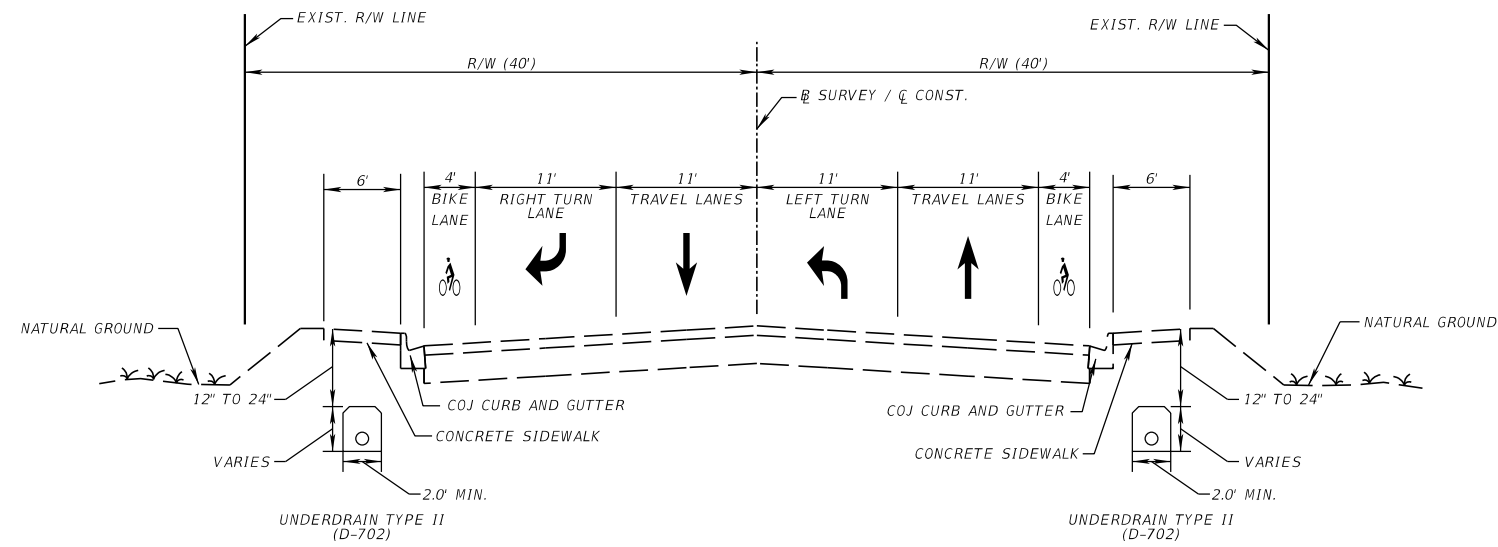

TYPICAL SECTION  
 SPRING GLEN RD.  
 (SPRING PARK RD. TO SPRING PARK RD.)  
 STA. 80+93.12 TO STA. 82+26.49

7/19/2024 10:43:36 AM cmushi C:\Users\cmushi\Documents\Benesch\C2C Typical Sections\Microstation\Existing\TYPSPRD01.dgn

REVISIONS				ENGINEER OF RECORD			EXISTING TYPICAL SECTION	SEGMENT NO.
DATE	DESCRIPTION	DATE	DESCRIPTION	ROAD NO.	COUNTY	FINANCIAL PROJECT ID		11
				VARIES	DUVAL	N/A		

THE OFFICIAL RECORD OF THIS SHEET IS THE ELECTRONIC FILE DIGITALLY SIGNED AND SEALED UNDER RULE 61G15-23.004, F.A.C.

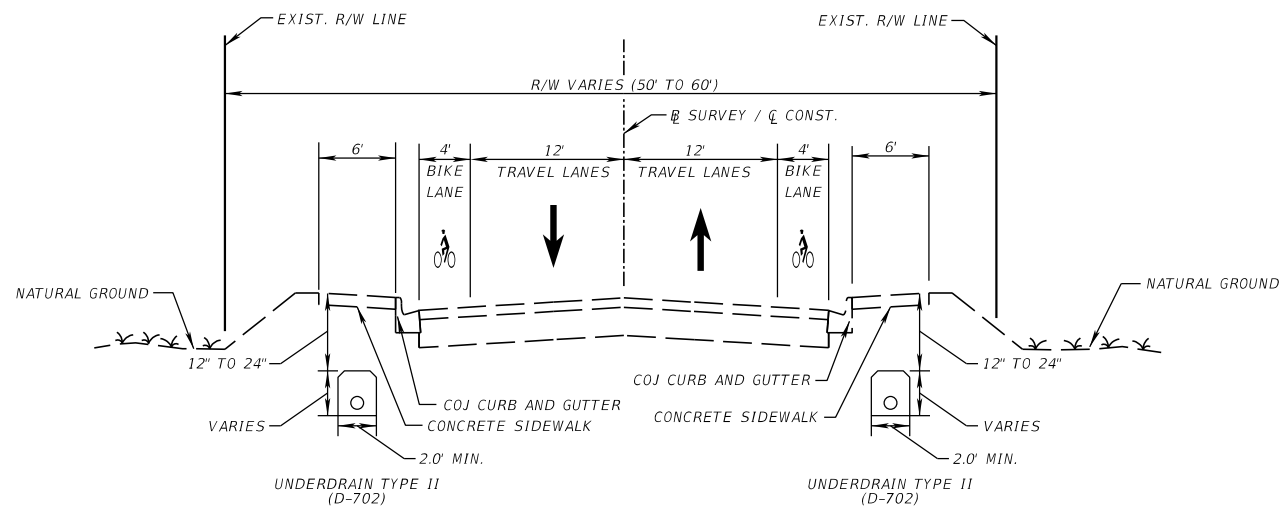

**TYPICAL SECTION  
 SPRING PARK RD.  
 (SPRING GLEN RD. TO UNIVERSITY BLVD.)  
 STA. 50+00.00 TO STA. 60+00.00  
 STA. 71+30.00 TO STA. 74+50.00  
 STA. 85+76.82 TO STA. 88+00.00  
 STA. 97+50.00 TO STA. 117+60.00**

7/19/2024 10:48:19 AM cmushi C:\Users\cmushi\Documents\Benesch\C2C Typical Sections\Microstation\Existing\TYPSPRD01.dgn

REVISIONS				ENGINEER OF RECORD			EXISTING TYPICAL SECTION	SEGMENT NO.
DATE	DESCRIPTION	DATE	DESCRIPTION	ROAD NO.	COUNTY	FINANCIAL PROJECT ID		12
				VARIES	DUVAL	N/A		

THE OFFICIAL RECORD OF THIS SHEET IS THE ELECTRONIC FILE DIGITALLY SIGNED AND SEALED UNDER RULE 61G15-23.004, F.A.C.

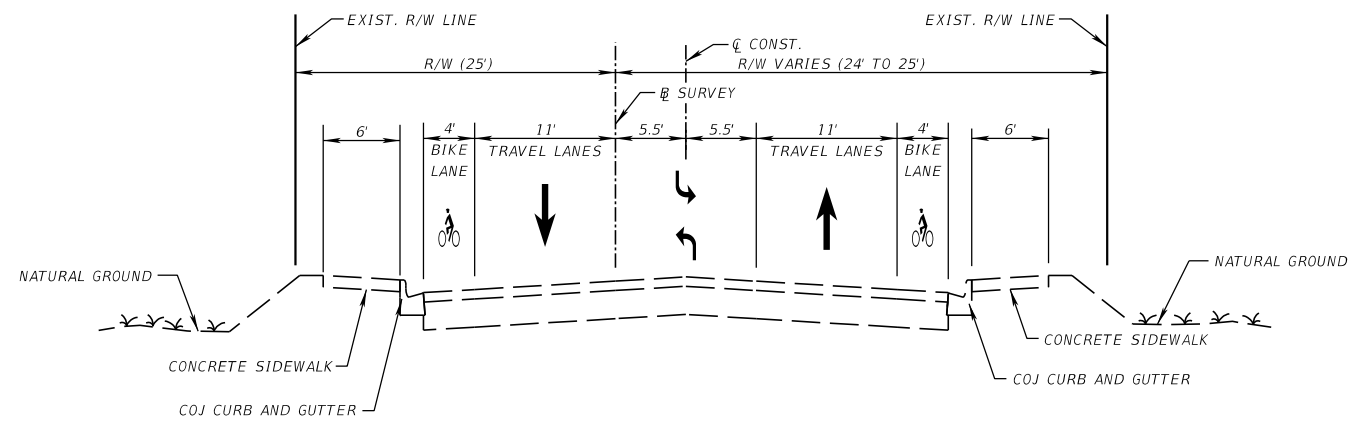

TYPICAL SECTION  
 SPRING PARK RD.  
 (UNIVERSITY BLVD. TO BOWDEN RD.)  
 STA. 30+43.00 TO STA. 50+50.00

7/19/2024 10:47:35 AM cmushi  
 C:\Users\cmushi\Documents\Benesch\C2C Typical Sections\Microstation\Existing\TYPSPAD01.dgn

REVISIONS				ENGINEER OF RECORD			EXISTING TYPICAL SECTION	SEGMENT NO.
DATE	DESCRIPTION	DATE	DESCRIPTION	ROAD NO.	COUNTY	FINANCIAL PROJECT ID		13
				VARIES	DUVAL	N/A		

THE OFFICIAL RECORD OF THIS SHEET IS THE ELECTRONIC FILE DIGITALLY SIGNED AND SEALED UNDER RULE 61G15-23.004, F.A.C.

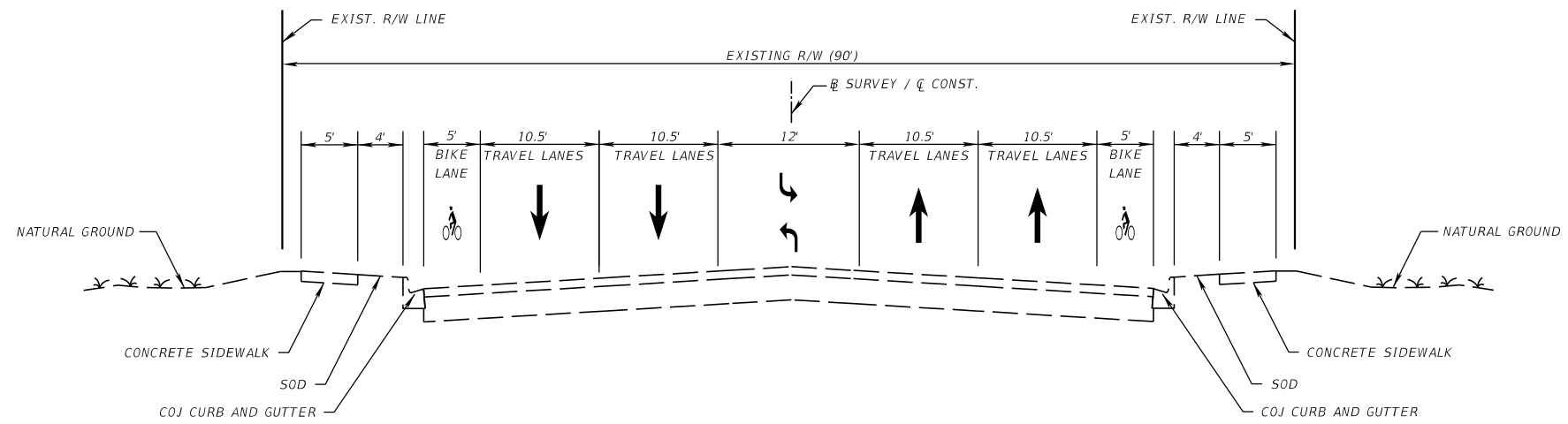

TYPICAL SECTION  
 BOWDEN RD.  
 (SPRING PARK RD. TO SOUTHPOINT PKWY)

7/19/2024 10:27:14 AM cmushi C:\Users\cmushi\Documents\Benesch\C2C Typical Sections\Microstation\Existing\TYPSTRD01.dgn

REVISIONS				ENGINEER OF RECORD			EXISTING TYPICAL SECTION	SEGMENT NO.
DATE	DESCRIPTION	DATE	DESCRIPTION	ROAD NO.	COUNTY	FINANCIAL PROJECT ID		14
				VARIES	DUVAL	N/A		

THE OFFICIAL RECORD OF THIS SHEET IS THE ELECTRONIC FILE DIGITALLY SIGNED AND SEALED UNDER RULE 61G15-23.004, F.A.C.

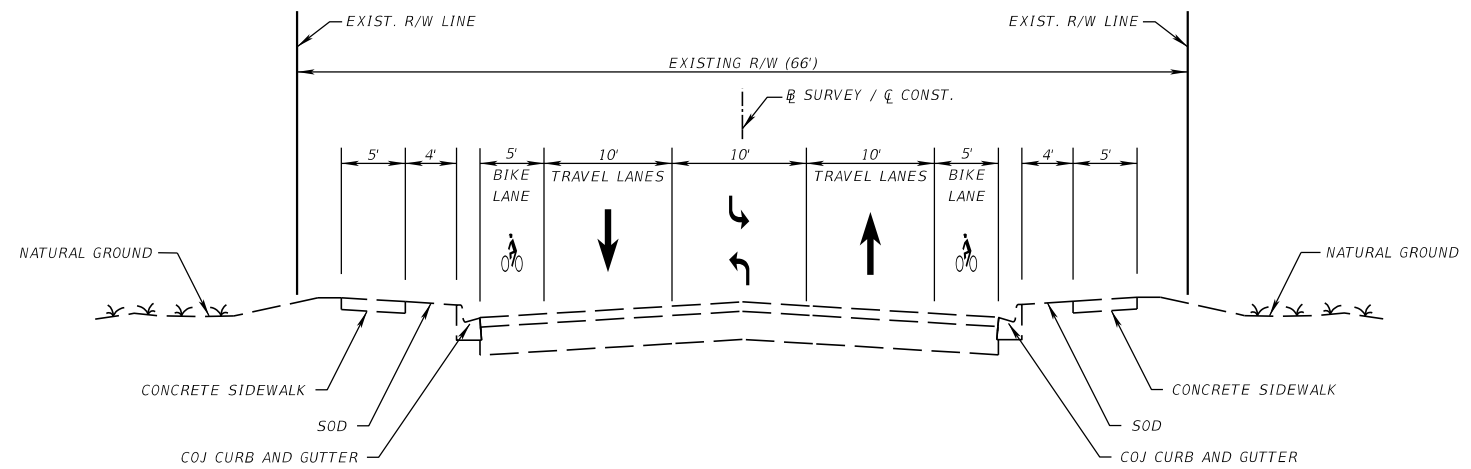

TYPICAL SECTION  
 BOWDEN RD.  
 (SOUTHPOINT PKWY TO PARENTAL HOME RD.)

7/19/2024 10:28:00 AM cmushi  
 C:\Users\cmushi\Documents\Benesch\C2C Typical Sections\Microstation\Existing\TYPSTRD01.dgn

REVISIONS				ENGINEER OF RECORD			EXISTING TYPICAL SECTION	SEGMENT NO.
DATE	DESCRIPTION	DATE	DESCRIPTION	ROAD NO.	COUNTY	FINANCIAL PROJECT ID		15
				VARIES	DUVAL	N/A		

THE OFFICIAL RECORD OF THIS SHEET IS THE ELECTRONIC FILE DIGITALLY SIGNED AND SEALED UNDER RULE 61G15-23.004, F.A.C.



7/20/2024 8:21:15 PM cmushi  
 C:\Users\cmushi\Documents\Benesch\C2C Typical Sections\Microstation\Existing\TYPICAL.dgn

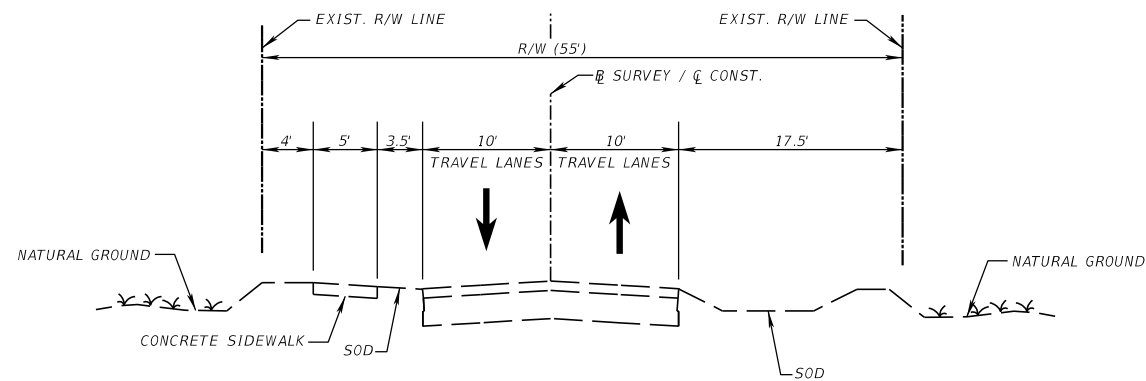

TYPICAL SECTION  
 BOWDEN RD.  
 (PARENTAL HOME RD. TO TIGER HOLE RD.)

REVISIONS				ENGINEER OF RECORD			EXISTING TYPICAL SECTION	SEGMENT NO.
DATE	DESCRIPTION	DATE	DESCRIPTION	ROAD NO.	COUNTY	FINANCIAL PROJECT ID		16
				VARIES	DUVAL	N/A		

THE OFFICIAL RECORD OF THIS SHEET IS THE ELECTRONIC FILE DIGITALLY SIGNED AND SEALED UNDER RULE 61G15-23.004, F.A.C.

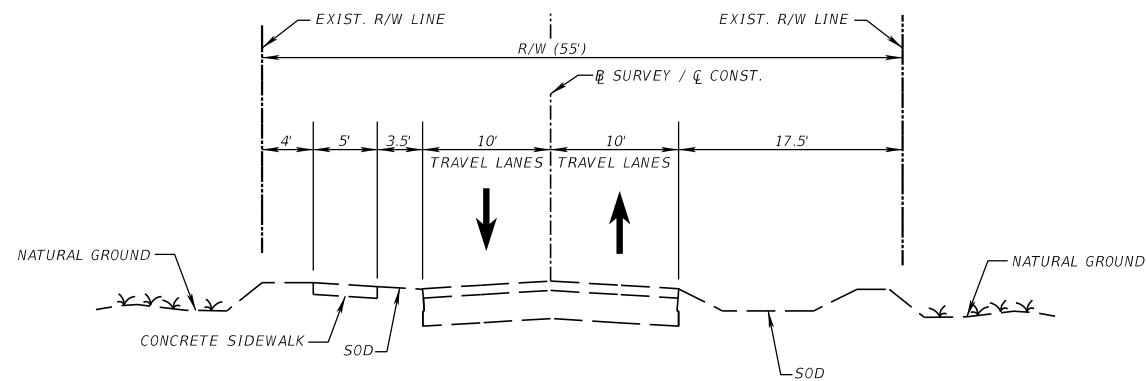

TYPICAL SECTION  
 BOWDEN RD.  
 (TIGER HOLE RD. TO BELFORT RD)

7/20/2024 8:22:13 PM cmushi C:\Users\cmushi\Documents\Benesch\C2C Typical Sections\Microstation\Existing\TYPISAD01.dgn

REVISIONS				ENGINEER OF RECORD			EXISTING TYPICAL SECTION	SEGMENT NO.
DATE	DESCRIPTION	DATE	DESCRIPTION	ROAD NO.	COUNTY	FINANCIAL PROJECT ID		17
				VARIES	DUVAL	N/A		

THE OFFICIAL RECORD OF THIS SHEET IS THE ELECTRONIC FILE DIGITALLY SIGNED AND SEALED UNDER RULE 61G15-23.004, F.A.C.

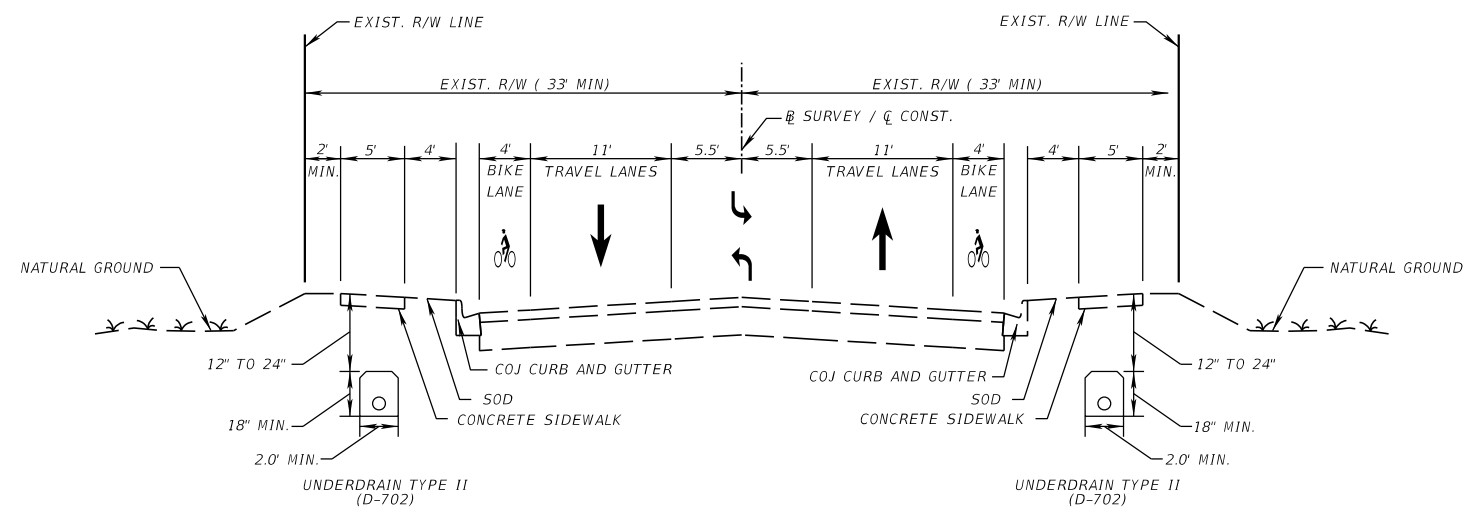

TYPICAL SECTION  
 BELFORT RD.  
 (BOWDEN RD S TO GATE PKWY W)

7/19/2024 10:25:40 AM cmushi C:\Users\cmushi\Documents\Benesch\C2C Typical Sections\Microstation\Exist\ng\TYPSPAD01.dgn

REVISIONS				ENGINEER OF RECORD			EXISTING TYPICAL SECTION	SEGMENT NO.
DATE	DESCRIPTION	DATE	DESCRIPTION	ROAD NO.	COUNTY	FINANCIAL PROJECT ID		19
				VARIES	DUVAL	N/A		

THE OFFICIAL RECORD OF THIS SHEET IS THE ELECTRONIC FILE DIGITALLY SIGNED AND SEALED UNDER RULE 61G15-23.004, F.A.C.

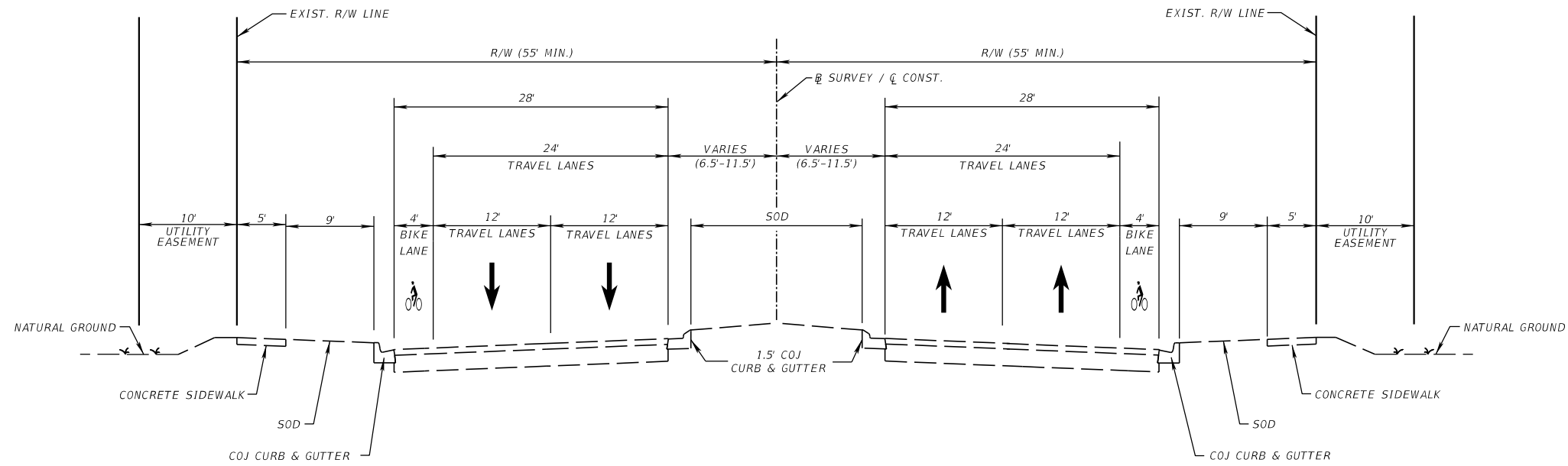

TYPICAL SECTION  
 GATEWAY PARKWAY  
 (BELFORT RD. TO SOUTHSIDE BLVD.)

7/19/2024 10:32:02 AM cmushi C:\Users\cmushi\Documents\Benesch\C2C Typical Sections\Microstation\Existing\TYPSPAD01.dgn

REVISIONS				ENGINEER OF RECORD			EXISTING TYPICAL SECTION	SEGMENT NO.
DATE	DESCRIPTION	DATE	DESCRIPTION	ROAD NO.	COUNTY	FINANCIAL PROJECT ID		20
				VARIES	DUVAL	N/A		

THE OFFICIAL RECORD OF THIS SHEET IS THE ELECTRONIC FILE DIGITALLY SIGNED AND SEALED UNDER RULE 61G15-23.004, F.A.C.

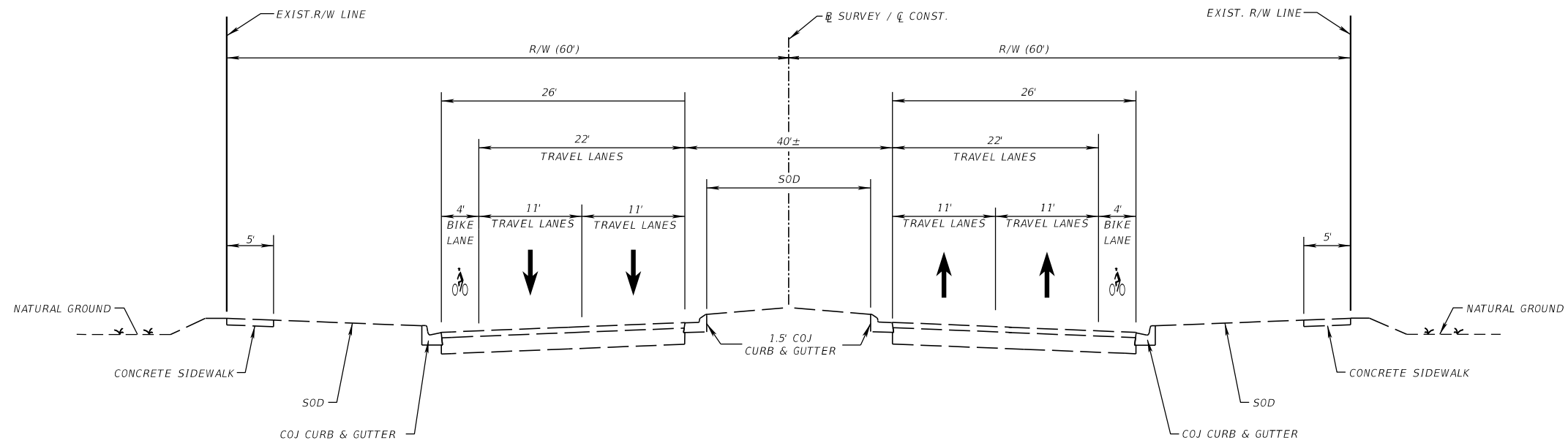

**TYPICAL SECTION**  
**GATE PARKWAY**  
 (SOUTHSIDE BLVD. TO TOWN CENTER PKWY.)  
 LEFT: STA. 14+29.86 TO STA. 75+54.33  
 RIGHT: STA. 12+22.99 TO STA. 73+00.00

7/19/2024 10:31:28 AM cmushi C:\Users\cmushi\Documents\Benesch\C2C Typical Sections\Microstation\Existing\TYPICAL.dgn

THE OFFICIAL RECORD OF THIS SHEET IS THE ELECTRONIC FILE DIGITALLY SIGNED AND SEALED UNDER RULE 61G15-23.004, F.A.C.

REVISIONS				ENGINEER OF RECORD			<b>EXISTING TYPICAL SECTION</b>	SEGMENT NO.
DATE	DESCRIPTION	DATE	DESCRIPTION	ROAD NO.	COUNTY	FINANCIAL PROJECT ID		21
				VARIES	DUVAL	N/A		

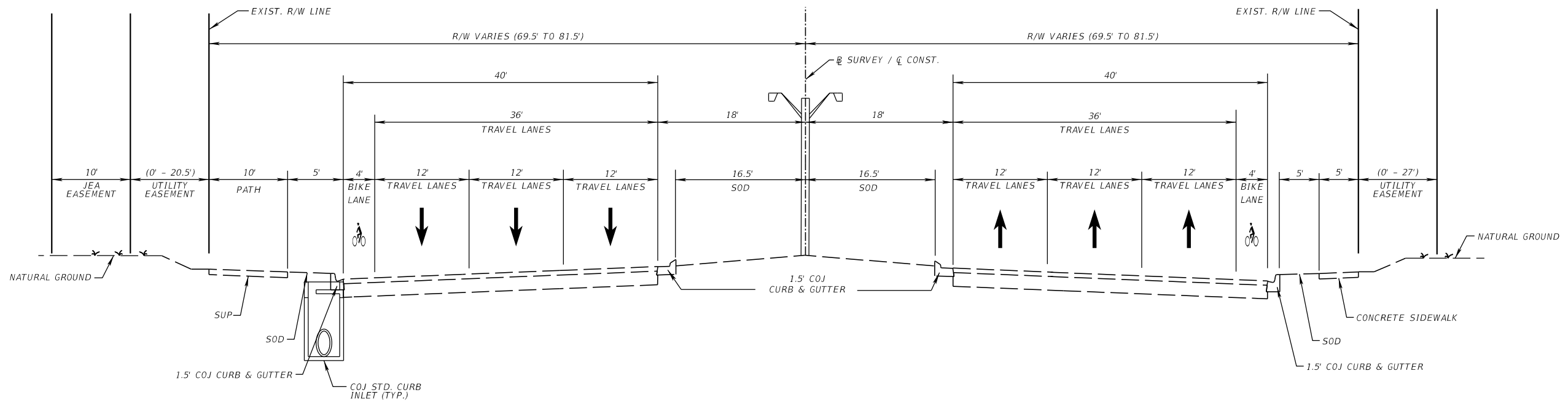

TYPICAL SECTION  
TOWN CENTER PARKWAY  
(GATE PKWY TO BRIGHTMAN BLVD)

7/19/2024 10:52:38 AM cmushi C:\Users\cmushi\Documents\Benesch\C2C Typical Sections\Microstation\Existing\TYPSPRD01.dgn

REVISIONS				ENGINEER OF RECORD			EXISTING TYPICAL SECTION	SEGMENT NO.
DATE	DESCRIPTION	DATE	DESCRIPTION	ROAD NO.	COUNTY	FINANCIAL PROJECT ID		22
				VARIES	DUVAL	N/A		

THE OFFICIAL RECORD OF THIS SHEET IS THE ELECTRONIC FILE DIGITALLY SIGNED AND SEALED UNDER RULE 61G15-23.004, F.A.C.

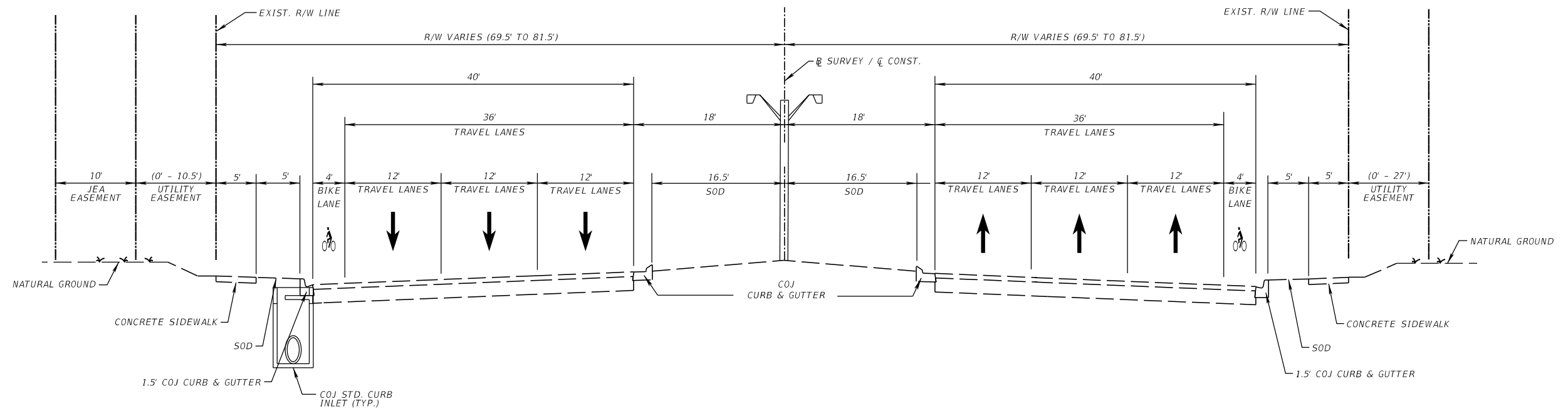

TYPICAL SECTION  
TOWN CENTER PARKWAY  
(BRIGHTMAN BLVD. TO UNF DR.)

7/17/2024 9:12:27 AM cmushi C:\Users\cmushi\Documents\Benesch\C2C Typical Sections\Microstation\Existing\TYPSPRD01.dgn

REVISIONS				ENGINEER OF RECORD			EXISTING TYPICAL SECTION	SEGMENT NO.
DATE	DESCRIPTION	DATE	DESCRIPTION	ROAD NO.	COUNTY	FINANCIAL PROJECT ID		23
				VARIES	DUVAL	N/A		

THE OFFICIAL RECORD OF THIS SHEET IS THE ELECTRONIC FILE DIGITALLY SIGNED AND SEALED UNDER RULE 61G15-23.004, F.A.C.

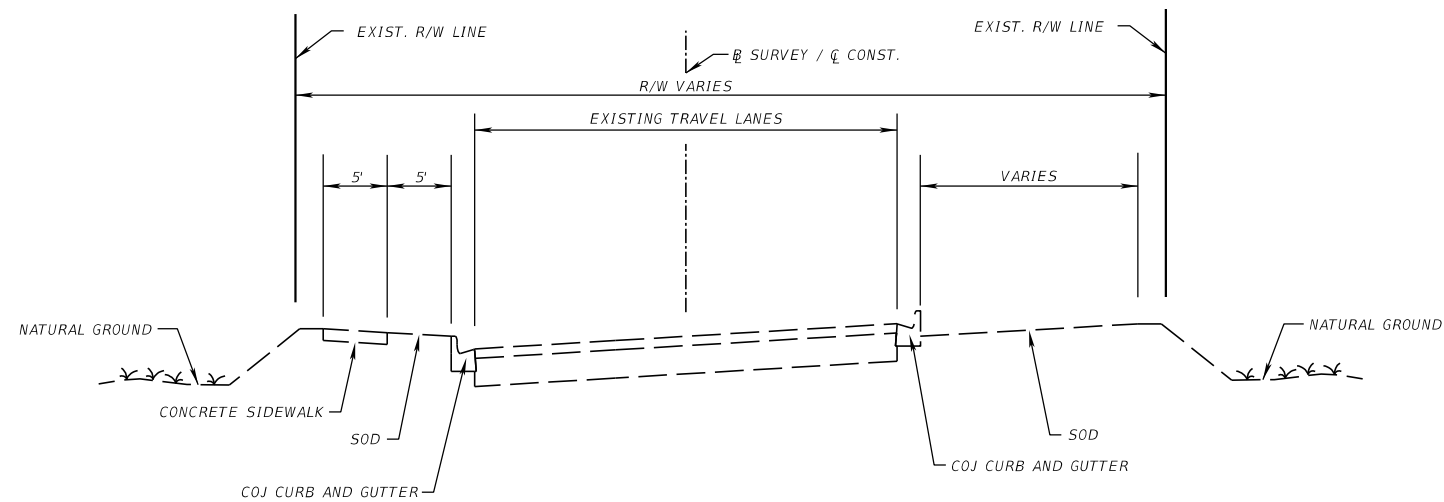

**TYPICAL SECTION**  
**UNF DR.**  
 STA. 108+15.23 TO STA. 121+19.76  
 STA. 121+34.31 TO STA. 132+95.74  
 STA. 108+44.81 TO STA. 109+90.73  
 STA. 110+43.58 TO STA. 111+92.43  
 STA. 112+07.31 TO STA. 125+42.68  
 STA. 125+66.19 TO STA. 129+54.54  
 STA. 130+17.33 TO STA. 131+65.43  
 STA. 132+65.43 TO STA. 133+07.78

7/19/2024 10:53:43 AM cmushi  
 C:\Users\cmushi\Documents\Benesch\C2C Typical Sections\Microstation\Existing\TYPSTRD01.dgn

REVISIONS				ENGINEER OF RECORD			<b>EXISTING TYPICAL SECTION</b>	SEGMENT NO.
DATE	DESCRIPTION	DATE	DESCRIPTION	ROAD NO.	COUNTY	FINANCIAL PROJECT ID		24
				VARIES	DUVAL	N/A		

THE OFFICIAL RECORD OF THIS SHEET IS THE ELECTRONIC FILE DIGITALLY SIGNED AND SEALED UNDER RULE 61G15-23.004, F.A.C.



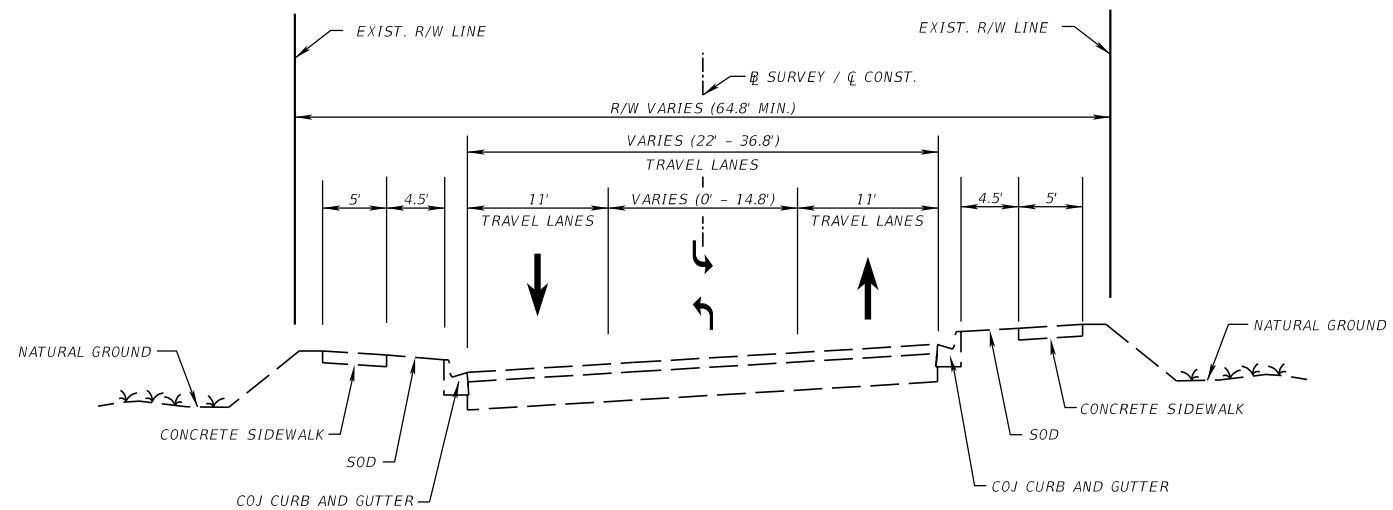

TYPICAL SECTION  
 UNF DR. SOUTH LOOP  
 (UNF DR. TO ALUMNI DR.)

7/19/2024 10:54:20 AM cmushi C:\Users\cmushi\Documents\Benesch\C2C Typical Sections\Microstation\Existing\TYPSPAD01.dgn

REVISIONS				ENGINEER OF RECORD	STATE OF FLORIDA DEPARTMENT OF TRANSPORTATION			EXISTING TYPICAL SECTION	SEGMENT NO.
DATE	DESCRIPTION	DATE	DESCRIPTION		ROAD NO.	COUNTY	FINANCIAL PROJECT ID		25
					VARIES	DUVAL	N/A		

THE OFFICIAL RECORD OF THIS SHEET IS THE ELECTRONIC FILE DIGITALLY SIGNED AND SEALED UNDER RULE 61G15-23.004, F.A.C.

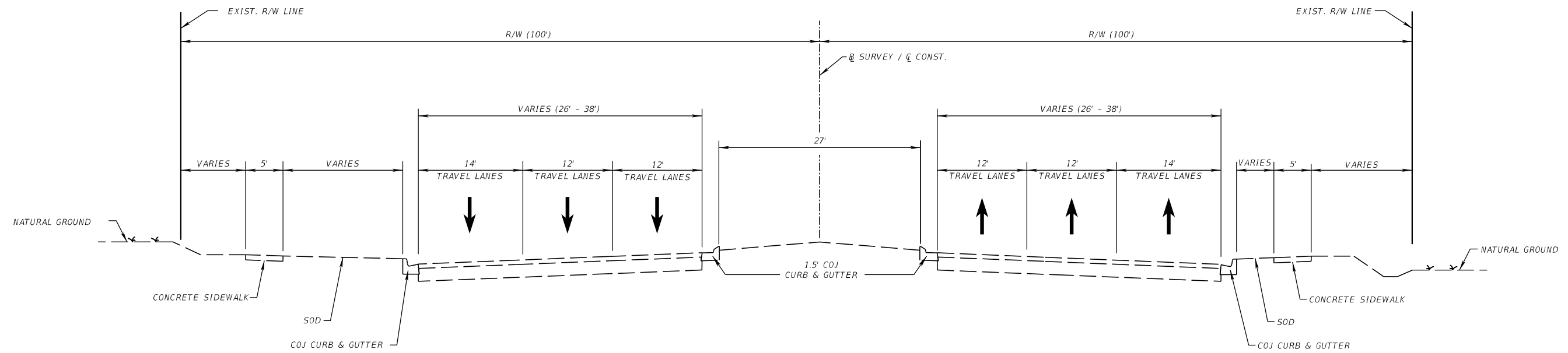

TYPICAL SECTION  
KERNAN BLVD.  
(ALUMNI DR. TO FIRST COAST TECH PKWY)

7/19/2024 10:40:55 AM cmushi C:\Users\cmushi\Documents\Benesch\C2C Typical Sections\Microstation\Existing\TYPSPRD01.dgn

THE OFFICIAL RECORD OF THIS SHEET IS THE ELECTRONIC FILE DIGITALLY SIGNED AND SEALED UNDER RULE 61G15-23.004, F.A.C.

REVISIONS				ENGINEER OF RECORD			<i>EXISTING TYPICAL SECTION</i>	SEGMENT NO.
DATE	DESCRIPTION	DATE	DESCRIPTION	ROAD NO.	COUNTY	FINANCIAL PROJECT ID		27
				VARIES	DUVAL	N/A		

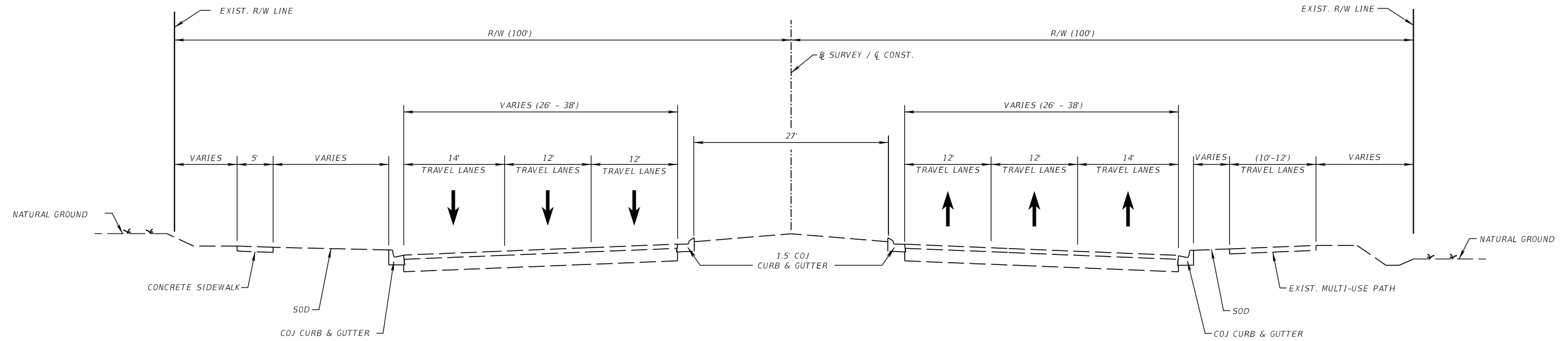

**TYPICAL SECTION**  
**KERNAN BLVD.**  
 (FIRST COAST TECH PKWY TO ASHLEY MELISSE BLVD.)

7/19/2024 10:41:36 AM cmushi C:\Users\cmushi\Documents\Benesch\C2C Typical Sections\Microstation\Existing\TYPSPRD01.dgn

THE OFFICIAL RECORD OF THIS SHEET IS THE ELECTRONIC FILE DIGITALLY SIGNED AND SEALED UNDER RULE 61G15-23.004, F.A.C.

REVISIONS				ENGINEER OF RECORD			<i>EXISTING TYPICAL SECTION</i>	SEGMENT NO.
DATE	DESCRIPTION	DATE	DESCRIPTION	ROAD NO.	COUNTY	FINANCIAL PROJECT ID		28
				VARIES	DUVAL	N/A		

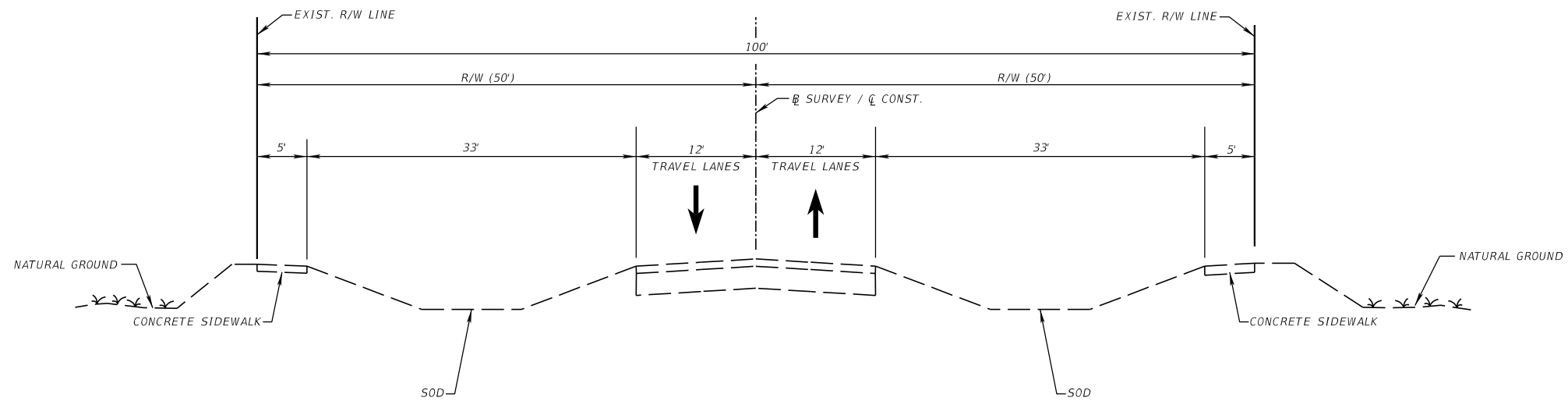

TYPICAL SECTION  
 ASHLEY MELISSE BLVD.  
 (KERNAN BLVD. TO GIRVIN RD.)

7/19/2024 10:25:03 AM cmushi  
 C:\Users\cmushi\Documents\Benesch\C2C Typical Sections\Microstation\Existing\TYPSPAD01.dgn

REVISIONS				ENGINEER OF RECORD			EXISTING TYPICAL SECTION	SEGMENT NO.
DATE	DESCRIPTION	DATE	DESCRIPTION	ROAD NO.	COUNTY	FINANCIAL PROJECT ID		29
				VARIES	DUVAL	N/A		

THE OFFICIAL RECORD OF THIS SHEET IS THE ELECTRONIC FILE DIGITALLY SIGNED AND SEALED UNDER RULE 61G15-23.004, F.A.C.

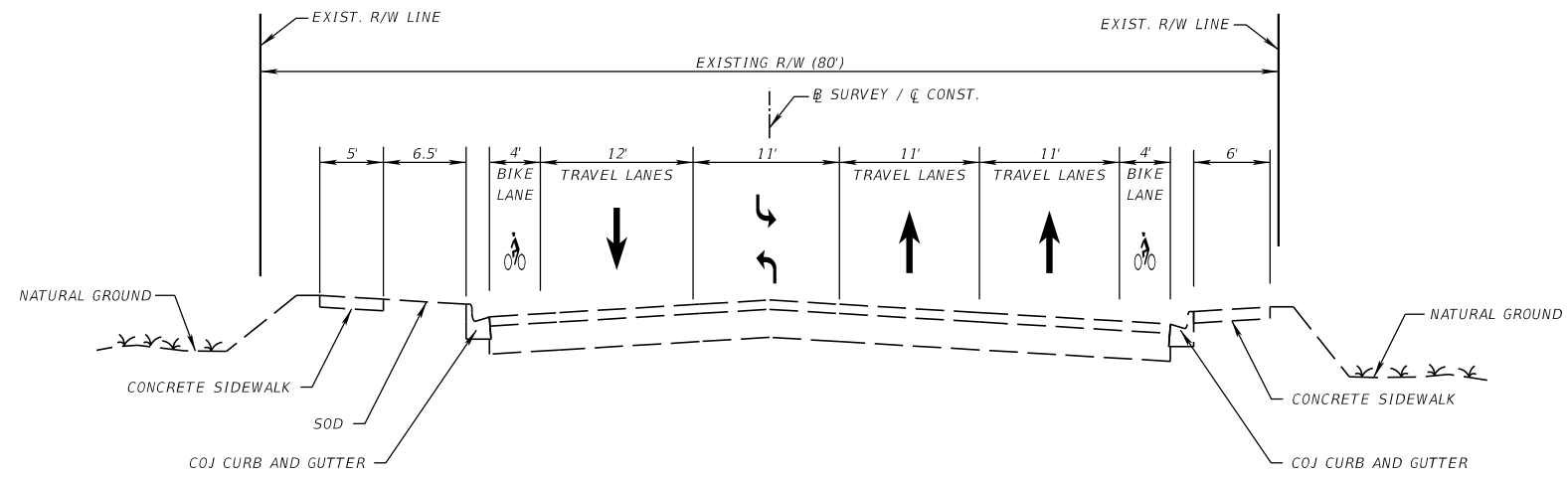

**TYPICAL SECTION**  
**GIRVIN RD.**  
**(ASHLEY MELISSE BLVD. TO WILDERLAND DR.)**  
**STA. 85+67.00 TO STA. 90+60.00**

7/19/2024 10:32:51 AM cmushi  
 C:\Users\cmushi\Documents\Benesch\C2C Typical Sections\Microstation\Existing\TYPISAD01.dgn

REVISIONS				ENGINEER OF RECORD			<b>EXISTING TYPICAL SECTION</b>	SEGMENT NO.
DATE	DESCRIPTION	DATE	DESCRIPTION	ROAD NO.	COUNTY	FINANCIAL PROJECT ID		30A
				VARIES	DUVAL	N/A		

THE OFFICIAL RECORD OF THIS SHEET IS THE ELECTRONIC FILE DIGITALLY SIGNED AND SEALED UNDER RULE 61G15-23.004, F.A.C.

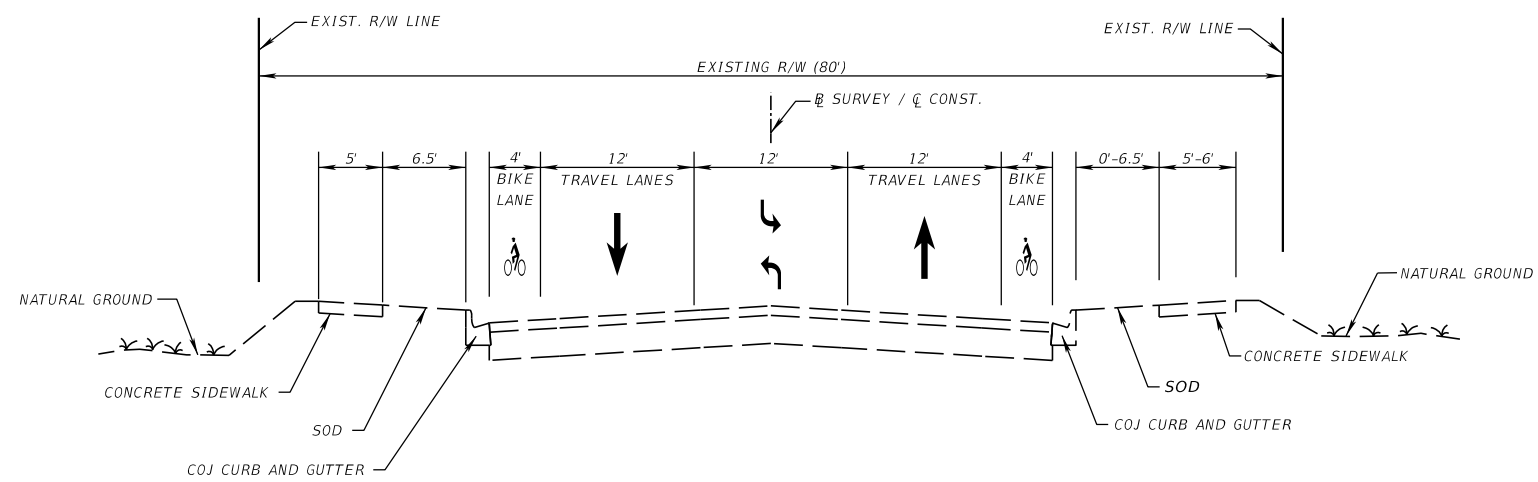

TYPICAL SECTION  
 GIRVIN RD.  
 (WILDERLAND DR. TO WONDERWOOD DR.)

7/19/2024 10:39:19 AM cmushi C:\Users\cmushi\Documents\Benesch\C2C Typical Sections\Microstation\Existing\TYPSTRD01.dgn

REVISIONS				ENGINEER OF RECORD			EXISTING TYPICAL SECTION	SEGMENT NO.
DATE	DESCRIPTION	DATE	DESCRIPTION	ROAD NO.	COUNTY	FINANCIAL PROJECT ID		30B
				VARIES	DUVAL	N/A		

THE OFFICIAL RECORD OF THIS SHEET IS THE ELECTRONIC FILE DIGITALLY SIGNED AND SEALED UNDER RULE 61G15-23.004, F.A.C.

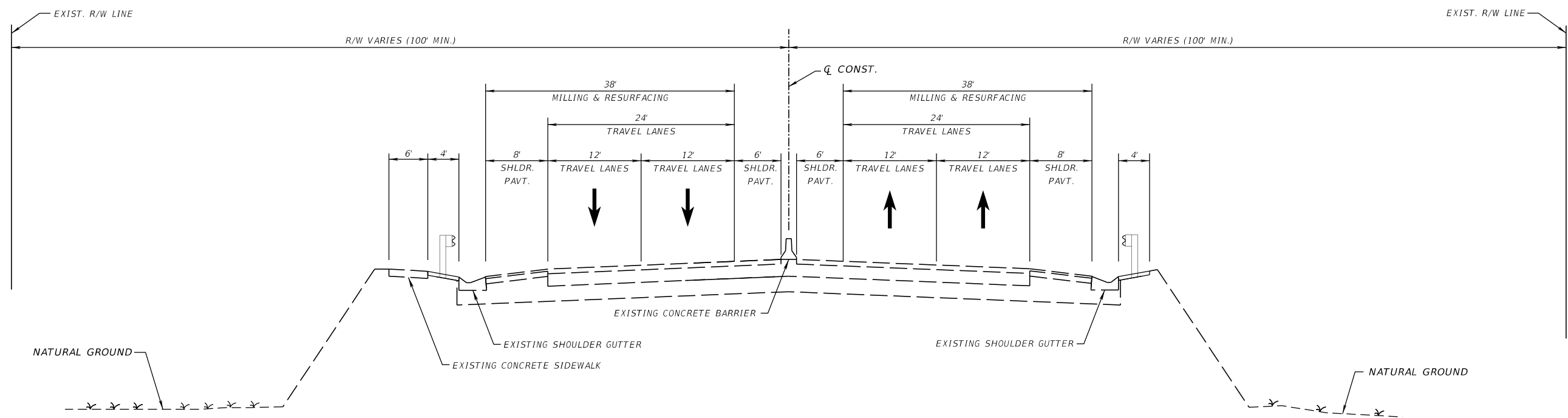

TYPICAL SECTION  
 SR 116 (WONDERWOOD DR.  
 (GIRVIN RD. TO SAND CASTLE LN.)

7/19/2024 10:55:48 AM cmushi C:\Users\cmushi\Documents\Benesch\C2C Typical Sections\Microstation\Existing\TYP SRD01.dgn

THE OFFICIAL RECORD OF THIS SHEET IS THE ELECTRONIC FILE DIGITALLY SIGNED AND SEALED UNDER RULE 61G15-23.004, F.A.C.

REVISIONS				ENGINEER OF RECORD			EXISTING TYPICAL SECTION	SEGMENT NO.
DATE	DESCRIPTION	DATE	DESCRIPTION	ROAD NO.	COUNTY	FINANCIAL PROJECT ID		31
				VARIES	DUVAL	N/A		

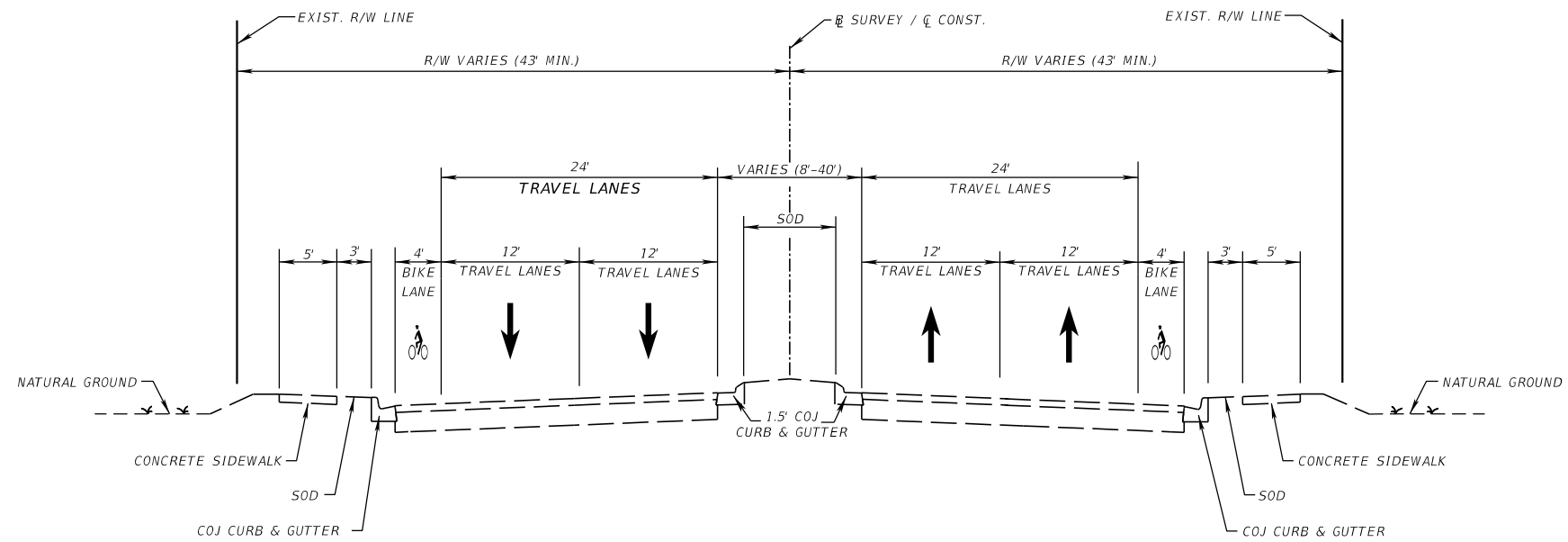

TYPICAL SECTION  
 SR 116 (WONDERWOOD DR.)  
 (SAND CASTLE LN. TO SR A1A)  
 STA. 282+70.00 TO STA. 285+57.717

7/19/2024 10:56:41 AM cmushi C:\Users\cmushi\Documents\Benesch\C2C Typical Sections\Microstation\Exist\ing\TYPSTRD01.dgn

THE OFFICIAL RECORD OF THIS SHEET IS THE ELECTRONIC FILE DIGITALLY SIGNED AND SEALED UNDER RULE 61G15-23.004, F.A.C.

REVISIONS				ENGINEER OF RECORD			EXISTING TYPICAL SECTION	SEGMENT NO.
DATE	DESCRIPTION	DATE	DESCRIPTION	ROAD NO.	COUNTY	FINANCIAL PROJECT ID		35
				VARIES	DUVAL	N/A		



# **APPENDIX C**

## **Presentation, Feasibility of Shared Use Paths within JEA Utility Corridors**



## Contact:

---

Matt Fall  
Bicycle-Pedestrian Coordinator  
MFall@coj.net





DUKE ENERGY TRAIL  
CLEARWATER, FL  
SOURCE: COJ

# FEASIBILITY OF SHARED-USE PATHS WITHIN JEA UTILITY CORRIDORS

JEA/COJ Discussion, February 28, 2022



Stephen Lee Davis / Smart Growth America

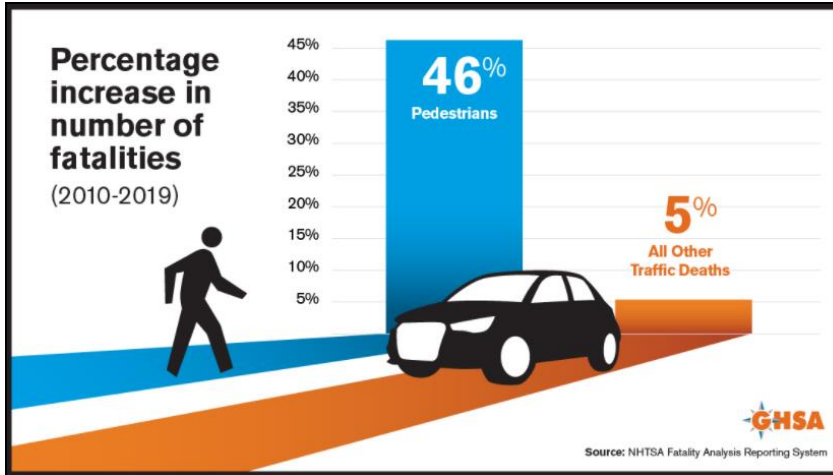

[GHSA.ORG/RESOURCES/PEDESTRIANS21](https://ghsa.org/resources/pedestrians21)

[SMARTGROWTHAMERICA.ORG/DANGEROUS-BY-DESIGN/](https://smartgrowthamerica.org/dangerous-by-design/)

# PEDESTRIAN TRAFFIC FATALITIES BY STATE: 2020 PRELIMINARY DATA (GHSA)

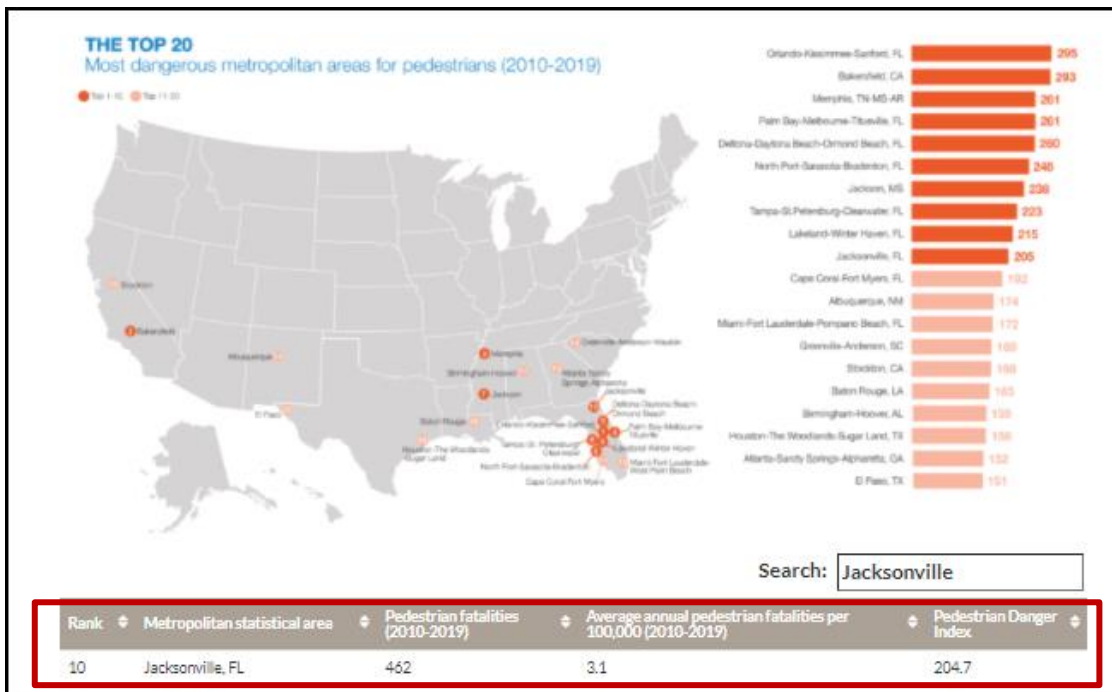

2010-2019:  
**462**  
PEDESTRIAN FATALITIES

SMART GROWTH AMERICA'S DANGEROUS BY DESIGN 2021



# Most Recent Data: 2018-2019

## National Highway Traffic Safety Administration (NHTSA)



**Traffic Safety Facts**  
2018 Data

July 2020 (revised) DOT HS 812 884



### Bicyclists and Other Cyclists

In 2018:

- Pedalcyclist fatalities were highest in Florida (161), California (155), and Texas (69). Every other State had 30 or fewer pedalcyclist fatalities.



**Traffic Safety Facts**  
2019 Data

October 2021 DOT HS 813 197



### Bicyclists and Other Cyclists

- Among large cities, the city with the highest pedalcyclist fatality rates was Tucson (1.09 pedalcyclist fatalities per 100,000 people), followed by Jacksonville (0.99 pedalcyclist fatalities per 100,000 people).



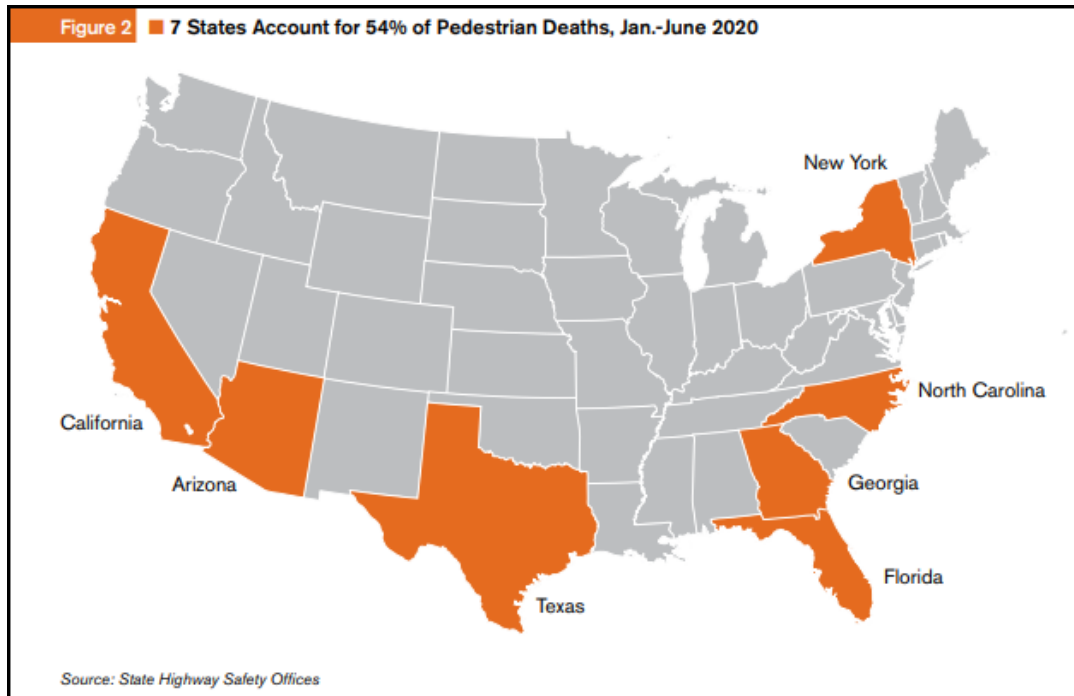

Jan-June 2020:

**7 States** Account for **54%**  
of TOTAL NATIONWIDE  
pedestrian fatalities

### FHWA-Designated Focus States and Focus Cities:

- Designated when bike-ped fatalities are consistently higher than the national average
- Florida (*Focus State*) and Jacksonville (*Focus City*) both designated

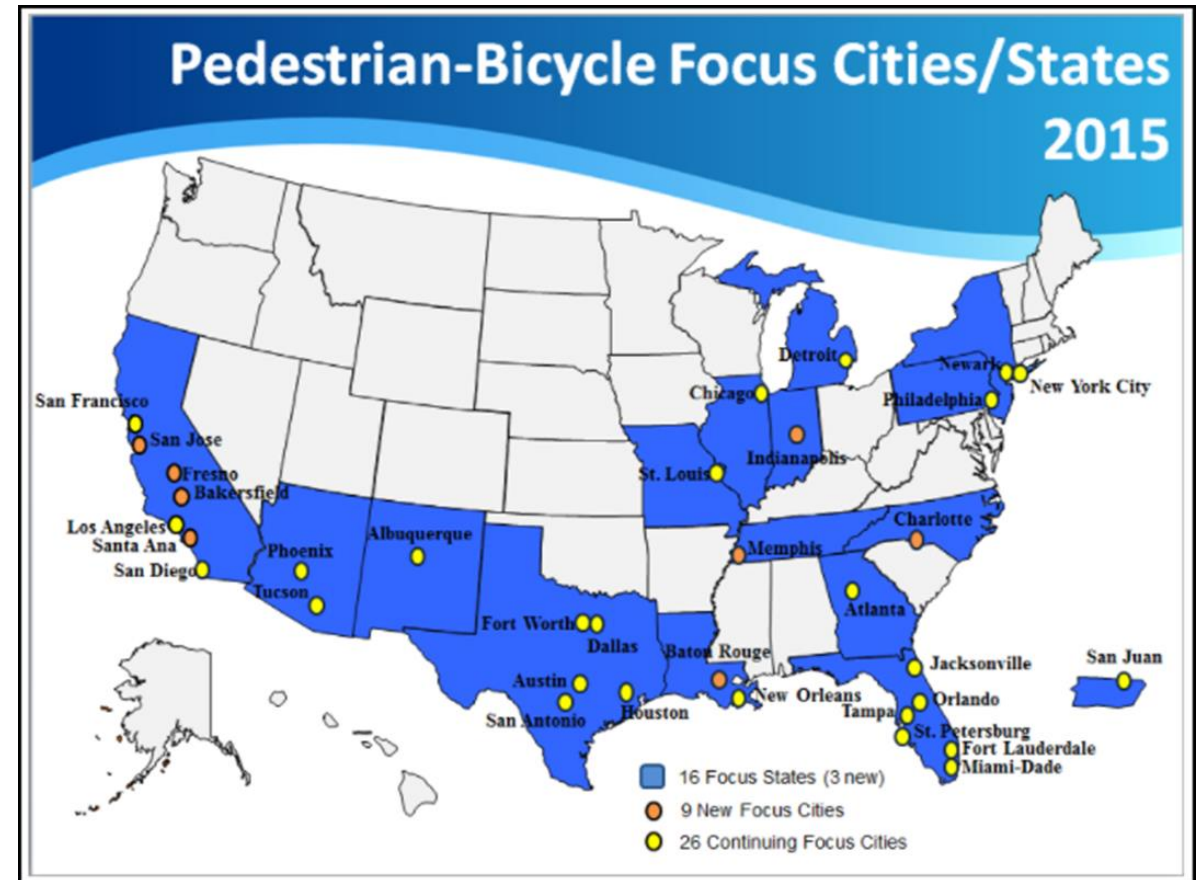

- **COJ's Top Goal:** Provide safe and connected sidewalks and bikeway facilities for residents of all ages and abilities
- **Hierarchy of Infrastructure:** Shared-use paths are MOST comfortable/safe for ALL
- **Greatest Barrier:** Right of way constraints
- **Utility Corridors:** Used successfully in most states, providing safe/comfortable infrastructure for communities



SOURCE: FLORIDAHIKES.COM

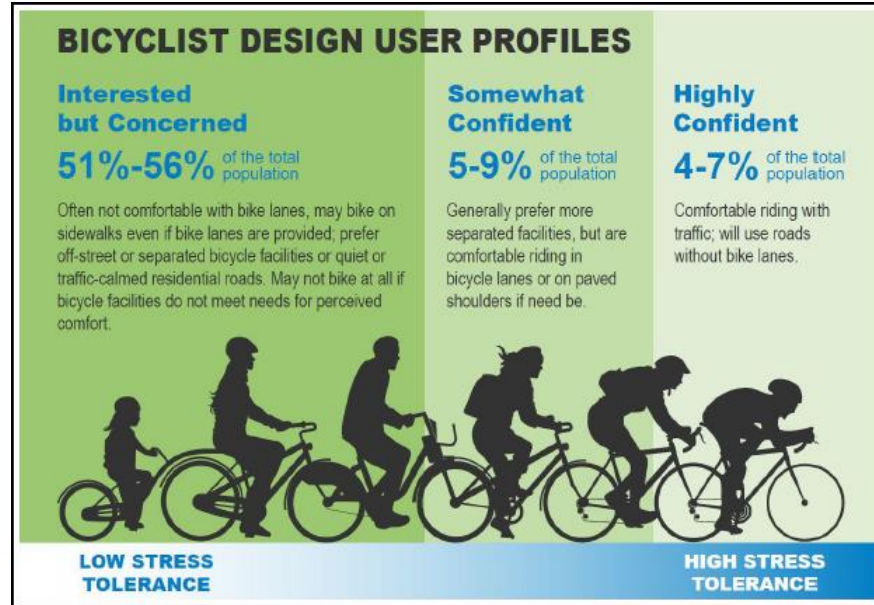

SOURCE: FHWA BIKEWAY SELECTION GUIDE



SOURCE: DANGEROUS BY DESIGN





**S-Line Rail Trail**  
Jax Main Street Jacksonville FL 32206

**Available Amenities**

- Bike Trail
- Hiking Trail



**Jacksonville Baldwin Rail Trail**  
850 N. Center Street Jacksonville FL 32234  
Open Sunrise Closed at Sundown

**Available Amenities**

- Benches
- Bike Racks
- Bike Trail
- Drinking Fountain
- Equestrian Trail
- Hiking Trail
- Parking
- Picnic Shelters
- Picnic Tables
- Restrooms
- Trash Barrels

# Success Stories: Rails-to-Trails in COJ





www.pedestrians.org



PAPILLION, NEBRASKA: WESTERN HILLS CONNECTOR



HORSHAM TOWNSHIP, PENNSYLVANIA: HORSHAM POWERLINE TRAIL



LIBERTY TOWNSHIP, OHIO: POWER LINE ROW TRAIL

DALLAS, TEXAS:  
PRESTON RIDGE TRAIL



# Utility Corridors: Throughout the Country

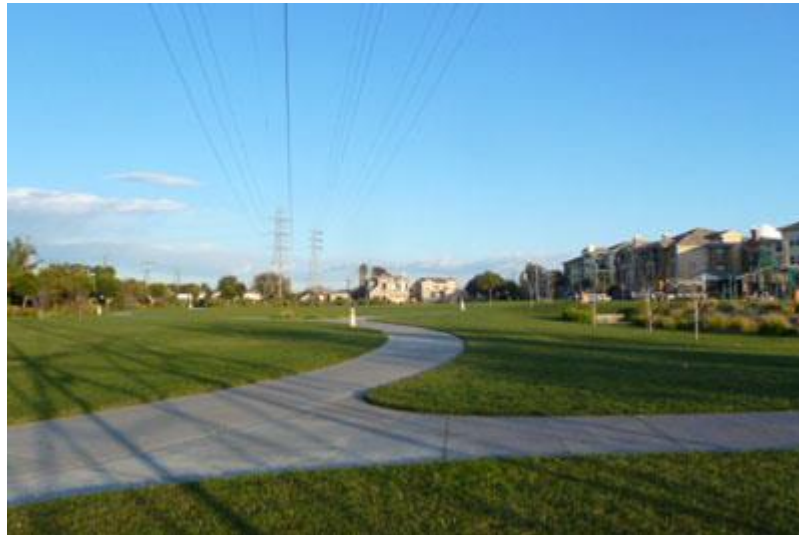

WEST WINDSOR, NEW JERSEY: TROLLEY LINE TRAIL



SEATTLE, WASHINGTON:  
CHIEF SEALTH TRAIL



# PINELLAS COUNTY, FLORIDA: DUKE ENERGY TRAIL: 4.1 MILES

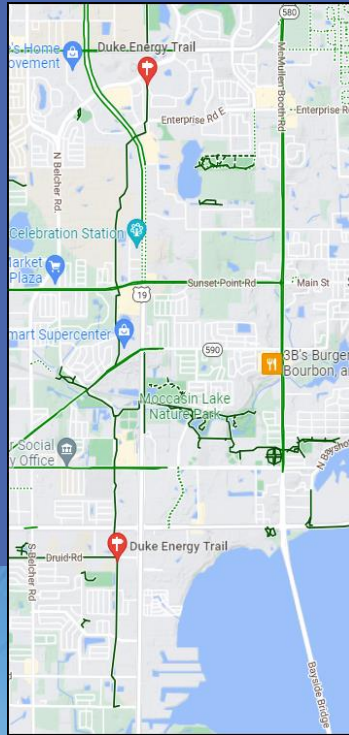

# AUBURNDALE, FLORIDA: TECO GAS AUBURNDALE TRAIL: 6.6 MI

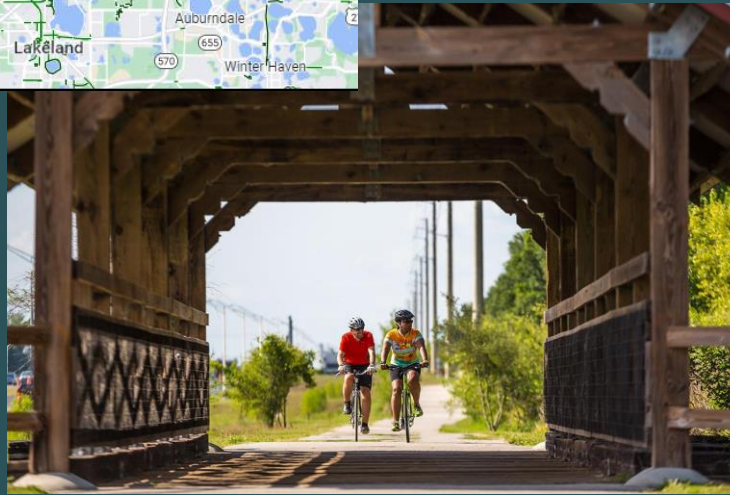
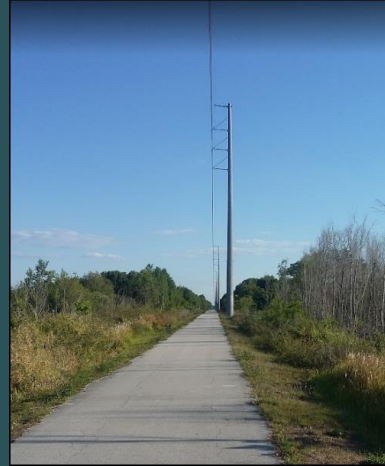
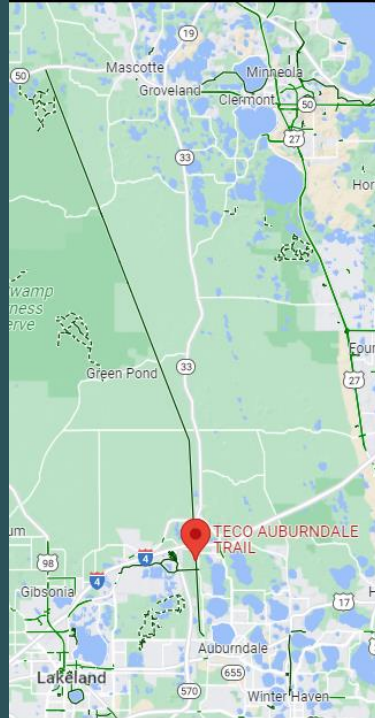

# VOLUSIA COUNTY, FLORIDA: SPRING-TO-SPRING TRAIL: VARIES

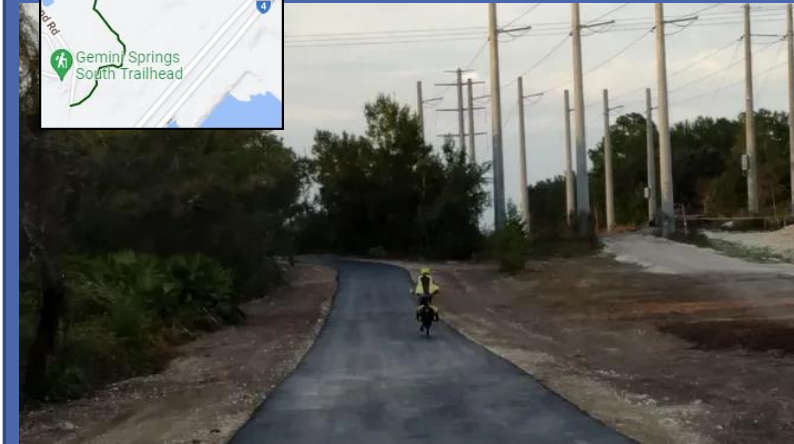
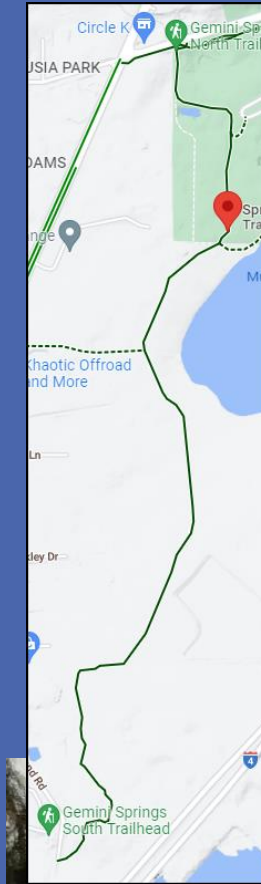

# From RailsToTrails.org

“

Neglected, unused space along a utility corridor... may also become a beautiful trail or functional cut-through with the proper negotiations. Frequently, this is done with pipelines or overhead electric corridors...

The Albertson Parkway in San Jose, Calif., which was once an unsightly utility corridor with a history of attracting crime, was developed into a winding bike path with pleasant landscaping through the negotiation of an easement with PG&E. The trail now sees frequent use from hikers, bikers and dog walkers.

”

**PASCO COUNTY, FLORIDA:  
SUNCOAST TRAIL:  
42 MILES WITH SECTIONS  
OF UTILITY EASEMENTS**



## Agreements

🚶 SUP funding, maintenance and liability on city

🚶 Sample agreements available

This document jointly prepared by the Parties Involved  
Return to:  
Attn:

### TRAIL AGREEMENT

THIS TRAIL AGREEMENT (this "AGREEMENT"), made this 19<sup>th</sup> day of May 2020 by and between DUKE ENERGY FLORIDA, LLC a Florida Limited Liability Company d/b/a Duke Energy (hereinafter referred to as "DUKE ENERGY"), the County of Volusia, a political subdivision of the State of Florida (hereinafter referred to as "COUNTY"), and the City of DeBary, a Florida Municipal Corporation (hereinafter referred to as "CITY"), and collectively referred to herein as the "PARTIES," as the for the construction of Phase 3B of the Spring to Spring Trail (hereinafter referred to as the "Trail");

### WITNESSETH:

WHEREAS, the COUNTY and CITY desire to construct, operate and maintain an approximately 2.9 mile public multi-use trail from Rob Sullivan Park to Highway 17/92 in the CITY , as depicted within the Overall depiction of the trail project enclosed attached as Exhibit A, and by this reference incorporated herein and made a part hereof); and

WHEREAS, DUKE ENERGY is the owner of the fee simple title to certain lands that serve as DUKE ENERGY's electric production plant, substation, and power lines in the County of Volusia and State of Florida as evidenced by an individual deed of conveyance appearing respectively among the Public Records of County of Volusia, Florida, and cited for reference on the tabulation attached hereto as Exhibit B, hereinafter referred to as the Properties and by this reference incorporated herein and made a part hereof; and



# Location of Bicycle/Pedestrian Fatalities and Incapacitating Injuries

Crash Data obtained from Signal4 Analytics.  
Data from January 2011 - December 2020



## Legend

### Crash Severity

- Fatality (380)
- Serious Injury (680)
- Streets
- Waterways
- Municipal Boundary

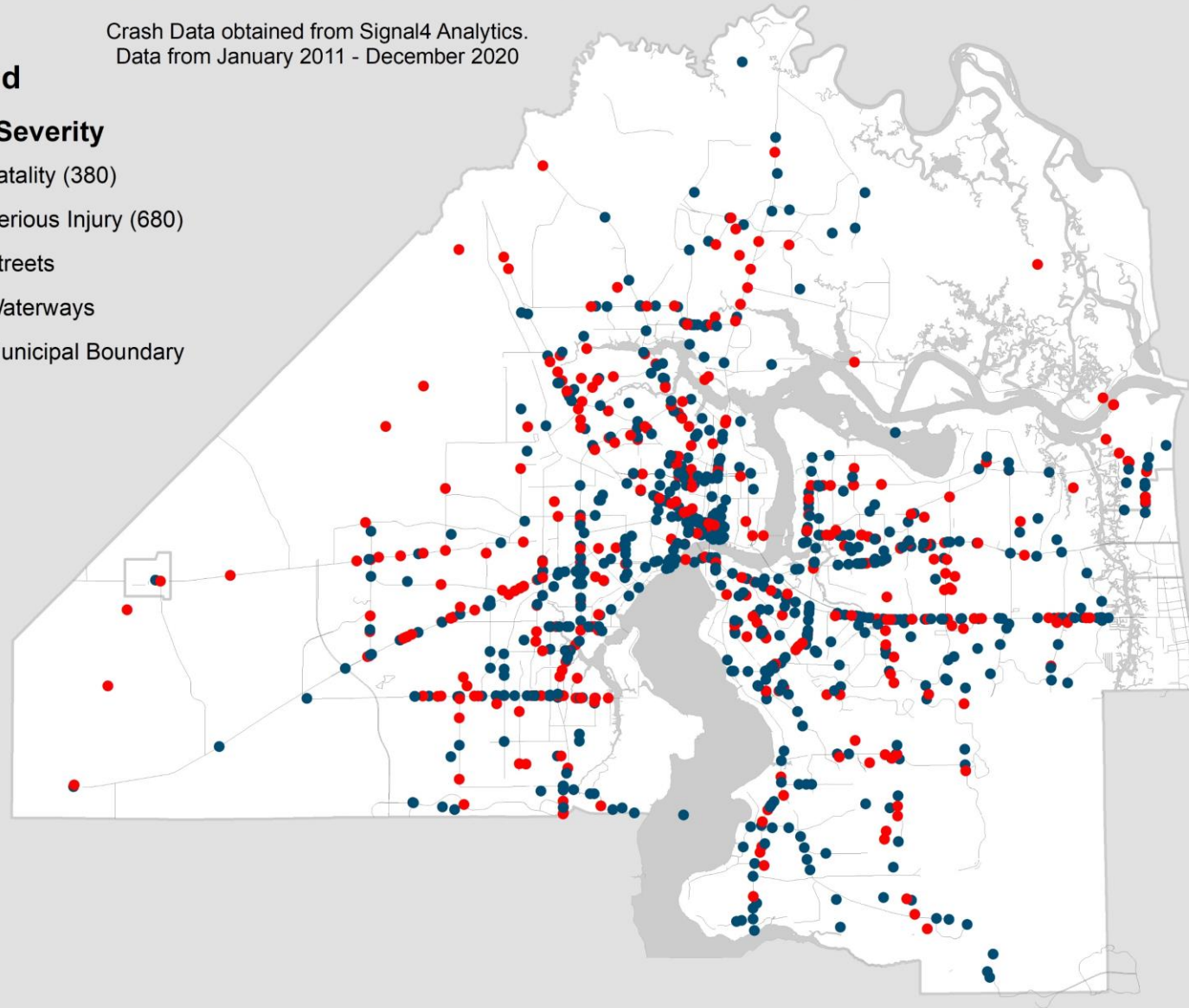

# Location of Bicycle/Pedestrian Fatalities and Incapacitating Injuries

Crash Data obtained from Signal4 Analytics.  
Data from January 2011 - December 2020



## Legend

### Crash Severity

- Fatality (380)
- Serious Injury (680)
- Streets
- Waterways
- Municipal Boundary
- Utility Corridor

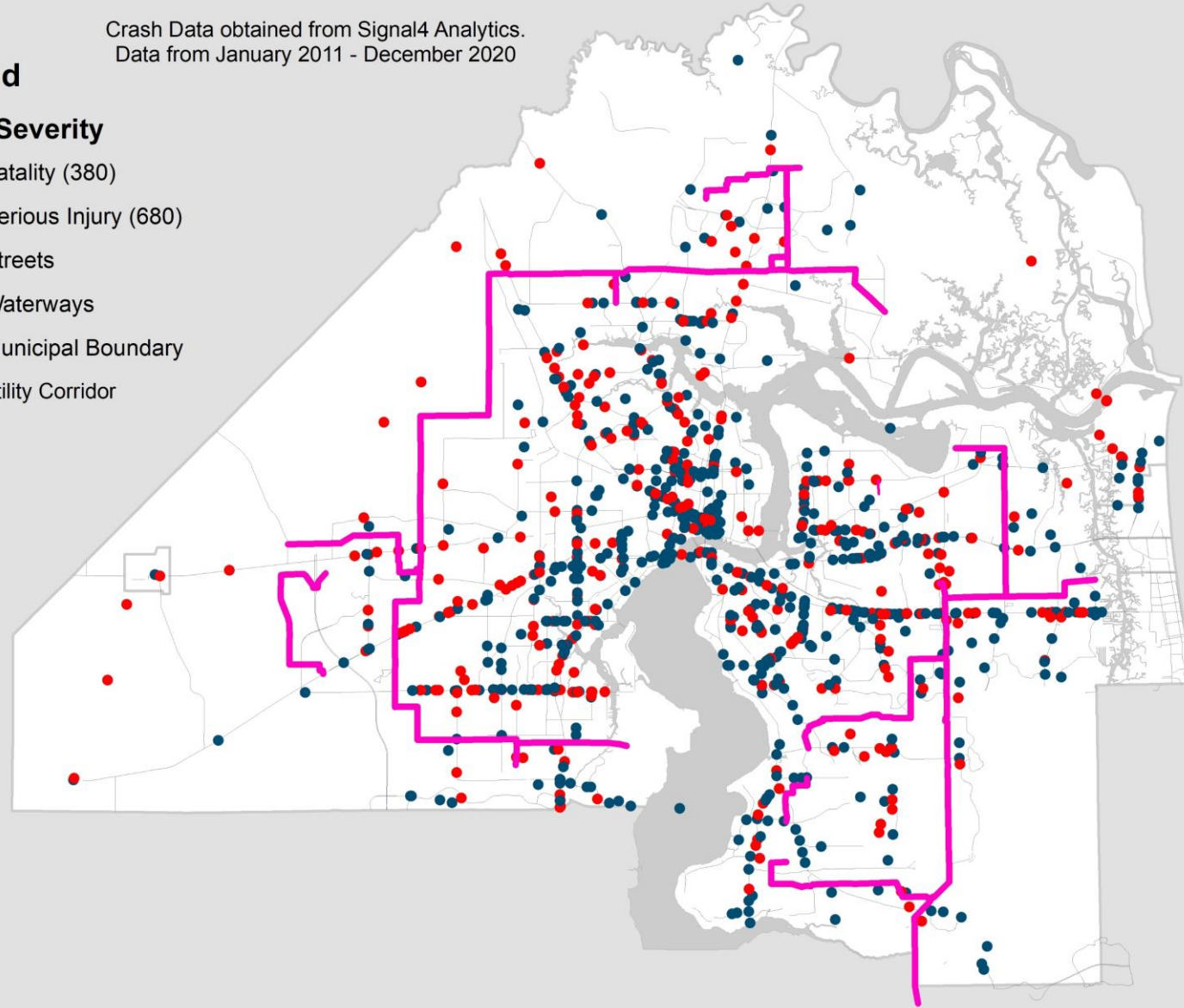

## Benefits to Utilities Agency

- 🚲 Trail naming, branding, media acknowledgement, eco-tourism
- 🚲 Employment incentive/retention, economic development
- 🚲 Community appreciation and recognition
- 🚲 Reduces crime in unused corridors and adjacent communities
- 🚲 Reduces fatalities and suspected serious injuries for bicyclists and pedestrians



# “Friends Of” Trail Groups

- Key to community involvement
- Trail amenities, trail events, wayfinding signage, branding, etc.
- Conduit between elected officials, city staff, and residents



- [youtube.com/watch?v=sdJlyqcyFSE](https://www.youtube.com/watch?v=sdJlyqcyFSE)
- [facebook.com/watch/?v=10153836414658704](https://www.facebook.com/watch/?v=10153836414658704)
- [youtube.com/watch?v=-kAy2hIOy24](https://www.youtube.com/watch?v=-kAy2hIOy24)
- [youtube.com/watch?v=T7JqUgW8x-U](https://www.youtube.com/watch?v=T7JqUgW8x-U)





# Next Steps

## Coordination Meetings (2022)

- All ROW/parcel owners brought to the table

## Feasibility Study (2022)

- Opinions of Probable Construction Costs (OPCCs)
- 15-45% engineering designs

## Funding (2023)

- RAISE grant funding, TAP funding, other discretionary grants
- Prioritized on LOPP, CIP





## Contact:

---

Matt Fall  
Bicycle-Pedestrian Coordinator  
MFall@coj.net



# **APPENDIX D**

## **Requests for Use of JEA Real Property Guidelines and Application**



# **Requests for Use of JEA Real Property**

## **Guidelines and Application**

### **Goals**

**The goals of this procedure are to ensure:**

- **The safety and best interest of the public.**
- **The integrity of the public utilities system;**
- **The protection and preservation of JEA land rights**

## **Table of Contents**

	<b>Page Number</b>
<b>INTRODUCTION</b>	<b>3</b>
<b>DEFINITIONS</b>	<b>3</b>
<b>THE APPLICATION PROCESS</b>	<b>5</b>
<b>TIME LIMITATIONS</b>	<b>6</b>
<b>GUIDELINES</b>	<b>6</b>
<b>APPLICATION INSTRUCTIONS</b>	<b>10</b>
<b>APPLICATION</b>	<b>12</b>

## **Introduction**

JEA's real property rights are valuable assets that must be protected to ensure the efficient delivery of the essential services of electricity, water, and sewage disposal. JEA property rights are acquired for the construction, operation, expansion, and maintenance of various utilities needed to serve its customers. JEA must have clear access to safely operate and maintain its facilities and to provide for future expansion. Ensuring public safety as well as preserving the land rights that have been acquired for the benefit of the public are the primary goals of this procedure. Nothing will be allowed on JEA property that violates state or federal laws, the City of Jacksonville Ordinance Code, the National Electric Safety Code (NESC), or other applicable laws.

JEA receives many requests from property owners, other governmental agencies, private utility companies, private corporations, and individuals to utilize its existing fee owned property and its easements. Proposed commercial and residential uses include parking lots, temporary storage, agricultural and livestock purposes, ingress/egress, decks, fences, and gardens. JEA also supports the collocation of facilities such as gas pipelines and communications technology.

This booklet provides applicants with guidance in gaining permission to utilize JEA real property for purposes compatible with JEA's safe and efficient delivery of service. Applicants must provide the requested information and attachments in order to avoid unnecessary delays in the application process. This booklet includes direction for preparing scaled drawings to submit with the application.

## **Definitions**

**Appurtenance:** Something that has been added or appended to a property and has since become an inherent part of the property; usually passes with the property when title is transferred. *See also* fixture.

**Buffer strip:** A parcel of land, usually unimproved except for landscaping and screening, that separates parcels with different land uses.

**Compatible Use:** JEA may determine that a requested use of JEA real property is compatible with JEA's current use of and future plans for the parcel(s). A requested use will be evaluated for compatibility with consideration given for all relevant factors such as current and future uses, use of surrounding parcels, safety, and costs.

**Conservation easement:** A restriction (usually imposed by state or federal law) that limits the future use of a property to preservation, conservation, or wildlife habitat.

**Easement:** A right afforded a person or entity to make limited use of another's real property for certain purposes. In easement areas, JEA has purchased specific rights from the underlying property owner, to construct, operate, and maintain power lines,

water and sewer lines, substations, and other structures necessary for the delivery of utility services. The underlying property owner may have certain rights defined in the original easement document which are consistent with JEA's rights in the property. Third parties may be allowed use of the JEA easements if the third party obtains permission from both JEA and the underlying property owner.

**Egress:** The right to leave a tract of land. Often used interchangeably with "access."

**Encroachment:** An encroachment is any infringement on the property or authority of another. Any use of JEA property is an encroachment. Encroachments are either licensed or unlicensed. The purpose of the Use of JEA Property Application Procedure is to provide a method to request a licensed encroachment and to insure that all licensed encroachments are compatible with JEA property rights. Unlicensed and impermissible encroachments pose a potential conflict with JEA's safe and efficient operation of its utilities facilities and are subject to action by JEA.

**Fee Owned property:** Absolute ownership unencumbered by any other interest or estate, subject only to the limitation imposed by the governmental powers of taxation, eminent domain, police power, and escheat. On fee owned property, JEA holds the title to the property and all the rights associated with land ownership. JEA may grant permits, leases, licenses, temporary easements, or perpetual easements for compatible purposes. Users are charged depending on the type of request.

**Fixture:** An article that was once personal property, but has since been installed or attached to the land or building in a rather permanent manner so that it is regarded in law as part of the real estate. *See also* appurtenance.

**Hold Harmless Agreement:** A legally binding agreement in which the liability of one party is assumed by another. The Hold Harmless Agreement usually accompanies a Use Agreement.

**Ingress:** The right to enter a tract of land. Often used interchangeably with "access".

**Lease:** An agreement between two (2) parties whereby one party, the lessor, yields his right of possession and use of some real or personal property for a specified period of time to a lessee in return for consideration.

**License:** A personal privilege to do some particular act or series of acts on land without possessing any estate or interest therein, and is ordinarily revocable at the will of the licensor and is not assignable. The permission by competent authority to do an act which, without such permission, would be illegal, a trespass, a tort, or otherwise unallowable. License agreements are renewable on an annual basis.

**Permit:** In general, any document which grants a person the right to do something. A license or grant of authority to do a thing. Permits are issued for a specific time period.

**Retention pond:** A man-made impoundment with a permanent pool of water that is used to reduce storm water runoff.

**Right of way:** A privilege to pass over the land of another in some particular path; usually an easement over the land of another; a strip of land used in this way for railroad and highway purposes, for pipelines or pole lines, and for private or public passage.

**Use Agreement:** A document which describes the approved benefit of the permittee, licensee, lessee, or easement holder permitted on JEA property. The Use Agreement is usually executed in conjunction with a Hold Harmless agreement.

**Wetlands:** Areas that are frequently saturated by surface or ground water at a frequency and duration sufficient to support vegetation adapted for life in saturated soil conditions. Section 404 of the Clean Water Act defines wetlands.

## **The Application Process**

1. The applicant must complete the application packet (providing the required attachments). Applications should be sent to:

JEA  
Real Estate Services, CC6  
21 West Church Street  
Jacksonville, FL 32202-3139

ATT: Director, Real Estate Services

Incomplete applications will be returned to the applicant and will cause delays in reaching a determination of approval, denial, or approval with conditions

2. Upon receipt of the application, a JEA Real Estate Services representative, will confirm that the information contained on the application is consistent with the drawings submitted. The representative will also check that proper clearances, both vertical and horizontal, are shown on the plans and all proposed changes are identified in relation to existing structures. The JEA representative may inspect the property.

3. The application will be considered by the JEA Property Use Evaluation and Recommendation Committee. The Committee is comprised of representatives from Real Estate, Development, Transmission, Distribution, Water and Sewer, Environmental, General Counsel, or other branch(es) of JEA making primary use of the JEA property. Other departments may review the application if deemed necessary by the Committee. The primary objectives of the Use of JEA Property Application Procedure are to ensure the safety of the public, the protection and preservation of JEA land rights, and the safety and integrity of the public utilities system. The investigation



will ensure that potential conflicts with other proposed projects do not exist. The Committee may impose additional requirements not stated in these Guidelines.

4. The Committee will consider the application within the guidelines listed on the following pages. It recommends the course of action to be taken.

5. Applicants will be notified within forty-five (45) days from receipt of a complete application packet. If the request is denied, the applicant will receive a letter of explanation. If the request is approved, the applicant will receive a letter stating that the request is approved as submitted or approved with conditions. A property use agreement must be signed prior to utilization of the property.

6. Insurance required: If the project is located on JEA fee owned lands, the applicant must provide proof of insurance with JEA as a named insured on either the insurance company's form or on JEA's form. The Applicant must provide the Agreement Number to the insurance company in the "Description of Operations" block on the form. The certificate of insurance must be on file prior to commencement of activities. The required policy amounts are:

General Liability and bodily injury \$200,000 each person and \$500,000 each person and \$1,000,000 each occurrence. Limits may vary depending on the type of use approved.

Property damage \$50,000 each occurrence and \$100,000 aggregate.

Proof of insurance must be updated annually. Failure to have a current Certificate of Insurance in JEA records may result in the cancellation of the agreement. It is the responsibility of the requester to supply JEA with annual proof of insurance.

7. Not all applications are automatically approved. The final agreement document will outline in detail the necessary safety requirements, specifications, insurance requirements, and fees.

### **TIME LIMITATIONS**

All approved applications are valid for one (1) year from the original date of approval. A new application will be required if the approved activity is not initiated within one year of the approval date.

### **GUIDELINES**

The following guidelines will assist in gaining permission for using JEA's fee-owned property and easements. The guidelines should be used in planning any project and should not be construed as permission to utilize JEA's properties without proper written permission. Written permission must be granted prior to use or implementation and

JEA Property Use and Hold Harmless Agreements may be required. The guidelines presented may not apply to all situations. JEA may impose additional requirements or modify the requirements stated here, depending on the proposed use and location.

1. No permanent structures may be erected on JEA property. This includes but is not limited to buildings, swimming pools, and decks.
2. The installation of retention ponds on JEA fee owned property is not permitted. Consideration may be given on JEA easements on a case-by-case basis where intrusion on a JEA easement is minimal. In general, stormwater facilities; retention or treatment ponds; and wetland mitigation areas adversely affect JEA's ability to repair and maintain its facilities and to provide quality utility service. In general, these uses of JEA easements are prohibited.
3. Permitted underground utilities may be approved if the following specifications are met: 1) The permitted underground utility requires less than a four (4) foot deep ditch and 2) The permitted underground utility maintains a fifteen (15) foot horizontal clearance from JEA underground structures; a ten (10) foot clearance from existing water mains, wastewater force mains, underground electric, natural gas and telecommunications utility facilities; and a fifteen (15) foot clearance from existing gravity sewer mains. The greater the depth or pipe diameter of JEA's existing facilities the further the horizontal distance required. Likewise, the greater the depth or pipe diameter of the proposed facilities, the further the horizontal distance required. Exceptions may be granted on a case by case basis with JEA approval.

Permitted utilities may be required to adjust and/or relocate the facilities at the owner's expense if the utility's facility is determined to be in conflict with JEA operation, maintenance and/or construction of existing or proposed utility facilities.

4. The installation of storm water pipes, drains, inlets and/or swales which cross JEA's rights-of-way may be permitted provided that such improvements do not adversely impact operation, maintenance, repair or future construction of utility facilities. Eighteen (18) inches of vertical clearance must be maintained between existing underground water and wastewater utilities. Thirty-six (36) inches of vertical clearance must be maintained between existing underground electric, natural gas, and telecommunications utilities. In most cases, a ten-foot (10') horizontal clearance will be required. However, individual proposals will be considered in light of Florida Department of Environmental Protection rules and other applicable rules.

Forty-two (42) inches of cover must be maintained over existing electric, natural gas, and telecommunications utilities. Thirty-six (36) inches of cover must be maintained over existing water and wastewater utilities. Installations below existing underground facilities will require special approval and may also require shoring and bracing during construction to protect the structural integrity of JEA's facilities.

5. Any excavation is prohibited within twenty-five (25) feet of any single wood pole structure and guying and within seventy-five (75) feet of any steel or concrete structure, and within ten (10) feet of any existing or proposed utility facility. This clearance is required for emergency repairs or routine maintenance of these structures.
6. In general, berms are not permitted on JEA property. Exceptions may be granted on a case by case basis with JEA approval.
7. Landscaping and shrubbery will be permitted as long as it does not interfere with JEA's access for maintenance or repairs. Shrubby must not exceed twelve (12) feet in height (at maturity) and must not be planted within fifteen (15) feet of any existing facility. Trees of any species are not permitted within any JEA electric, water or sewer right-of-way. All installation and maintenance will be the responsibility and at the expense of the property owner. Vegetation deemed by JEA to be a risk to JEA facilities or to be in conflict with JEA's operation, maintenance or construction of facilities shall be removed. For planting near transmission lines, the applicant should refer to the document, "JEA Recommended Trees for Planting within Easement Areas".

The permittee will be required to provide adequate watering of landscaping, sod, seed, or mulch as required to ensure proper growth.

The permittee will be required to remove or replace any dead or unsuitable landscaping, or sod at JEA's request.

8. JEA receives requests from landowners to temporarily store materials within transmission rights-of-way. Each request will be reviewed by the transmission group and must include a drawing showing the location, means of distribution or storage of material (height/type) and a description of the material to be stored. The following restrictions will apply:
  - A. There must be unobstructed access to all structures at all times. These structures may include poles, towers, and well sites.
  - B. No material can be stored within a seventy-five (75) foot radius of any structure.
  - C. No material may be stored on defined patrol roads or within a twelve (12) foot access way.
  - D. No berm or stacking is allowed directly beneath transmission lines. Spoil material may be stored temporarily between the outermost transmission line and the edge of the right-of-way. However, every case must be reviewed individually.
  - E. There will be a stated length of time permitted for the requested storage.
  - F. Any excavation is prohibited within twenty-five (25) feet of any single wood pole structure and guying and within seventy-five (75) feet of any steel or concrete structure, and within ten (10) feet of any existing or proposed utility facility. This clearance is required for emergency repairs or routine maintenance of these structures.

9. A level twelve (12) foot wide access road must be maintained along the length of a utility corridor. This corridor must be clear for vehicle access with no planted trees or shrubs.
10. Road or driveway crossings and paved parking may be permitted. Each request will be assessed individually.

Parking areas may be permitted if not directly beneath overhead transmission lines and in the sole discretion of JEA. Parking areas will not unreasonably interfere with JEA's use of the affected lands. Permitted driveways and parking areas are subject to removal by JEA for the operation, maintenance, repair, and/or installation of utility facilities.

JEA may require the installation of conduits to allow for future utility extension by JEA in conjunction with the construction of a road, driveway crossing, and/or parking area.

Permittee will be responsible for any restoration required to their permitted driveway or access road as a result of JEA's use of the property for installation, operation or maintenance of its utility facilities, unless otherwise agreed to in writing by both parties.

11. Any barriers, including fences, across the property will require a minimum of one gate, sixteen (16) feet in width, at each barrier. Barriers shall be grounded and should not exceed six (6) feet in height. A JEA system lock will be required in order for JEA personnel to have access at all times.
12. Poles, signs, or light fixtures are not permitted without prior express approval by JEA.
13. Where ingress/egress easements are sought, applicants must adhere to all of the guidelines outlined above. Applicants will be required to provide a legal description and sketch of the easement area prepared by a registered land surveyor attached to the application.
14. Changes to ground elevations will meet the required JEA construction and design standards for subsurface, surface, and aerial clearances. Changes in ground elevations shall not adversely alter the existing drainage characteristics of the property. Any grade change performed in such a manner to create a pond which would have standing water in it at any time is prohibited.
15. The permittee will be required to restore approved utilization areas to as close to the original condition as possible, by grading, removal of trash, debris and rocks, and re-sodding or seeding and mulching in accordance with JEA standards and as may be specified by JEA's special conditions of approval.

16. JEA's approval of the applicant's use of JEA property does not relieve the applicant of obtaining additional approvals as may be required by other federal, state, or local authorities or regulatory agencies including but not limited to wetlands permitting and landscaping and tree ordinances. Expenses incurred by the applicant in meeting any of these requirements are the obligation of the applicant and not JEA.

## **APPLICATION INSTRUCTIONS**

Applications and additional information may be obtained from JEA Real Estate Services, 665-6581. To avoid delays in the approval process please complete all required sections and attach the following:

- A. A general location map.** Draw the location map on 8 ½ "x 11" paper and make it detailed enough that someone unfamiliar with the area can find the project site. At minimum the map should include a north arrow, major roads, prominent landmarks, a reference to the nearest city or town, and detailed directions from the nearest major intersection to the project site.
- B. Tax identification map.**
- C. Legal Description of the impacted area.**
- D. Title Search,** a title search of the Legal Description (subject property) no older than 60 days from the date of the application.
- E. A detailed drawing and description of the proposed activity.**  
**The drawing must:**
  - 1. Be on standard sized paper (8 ½ x 11, 8 ½ x 14, 11 x 17, 18 x 24, 24 x 36, etc).
  - 2. Be to scale.
  - 3. Show and label existing and proposed vegetation by specie and mature height.
  - 4. Show existing utilities (underground and overhead) and improvements. All should be clearly labeled and dimensioned from the right of way. Include pipes, conduits, cables, manholes, valves, fire hydrants, poles, guys, etc.
  - 5. Show all JEA structures (poles, guy wires, access roads, etc).
  - 6. Label each JEA structure with its structure number.
  - 7. Show the existing JEA right of way with dimension width.
  - 8. Dimension the distance from the power line(s) to the edges of the right way.
  - 9. Show the applicant's name and daytime phone number.
  - 10. Show one boxed note that includes the county, section, township, and range.
  - 11. Show a north arrow.
  - 12. Show proposed project inside the right of way, clearly labeled, and dimensioned from the right of way.
  - 13. Include anything else that will assist in processing the application.

**The description must clearly:**

1. Describe the proposed project consistent with the project drawing.
2. Indicate Jack and Bores or Directional Bores with casing size, type, and depth. Also, cross-section of bore.
3. Describe method of installation of underground lines.
4. Describe pavement and/or driveway width, if applicable, showing existing and proposed elevations, contours, pavement grades, pavement material, typical pavement cross section, base and sub base material and depth.
5. Describe method of ground restoration (sod, seed, mulch).

**F. Easement Document**, if the requester is the underlying property owner.

Send the completed application with all required attachments to:

JEA  
Real Estate Services, CC6  
21 West Church Street  
Jacksonville, FL 32202-3139

ATT: Director, Real Estate Services

If technical assistance is needed prior to submitting the application, please contact Real Estate Services at 665-6581.

For a copy of the document "JEA Recommended Trees for Planting within Easement Areas", contact JEA Real Estate Services at 665-6581.

Mail completed applicaton to:  
JEA  
Real Estate Services, CC6  
21 West Church Street  
Jacksonville, FL 32202-3139  
Att: Director, Real Estate Services

For JEA use only:  
JEA Application No.: \_\_\_\_\_  
Date rec'd. \_\_\_\_\_

**APPLICATION FOR LICENSED ENCROACHMENT**

**APPLICANT**

IS THIS APPLICATION THE RESULT OF A VIOLATION LETTER? Yes \_\_\_\_\_  
No X If so, attach a copy of the letter.

NAME (individual or firm to be named in the agreement): CITY OF JACKSONVILLE

ADDRESS (INCLUDING ZIPCODE): 214 N. HOGAN ST, 32202

TELEPHONE NUMBER (INCLUDING AREA CODE): (904) 255-7902

FAX NUMBER: (904) 255-7940

E-MAIL ADDRESS: ICHRISTIANSEN@COJ.NET

**APPLICANT'S LEGAL CLASSIFICATION**

State the applicant's legal classification and, if applicable, show the state in which the firm is incorporated. Please provide the company name and title and name of the person authorized to sign.

Corporation \_\_\_\_\_ Partnership \_\_\_\_\_ Sole Proprietor \_\_\_\_\_  
Individual \_\_\_\_\_ Florida Municipal Corporation X

Company Name: CITY OF JACKSONVILLE

Authorized Signer: DARYL JOSEPH Title: DIRECTOR

Address (including zipcode): 214 N. HOGAN ST, 32202

E-mail address: DJOSEPH@COJ.NET

Phone number: (904) 255-7903 Fax number: (904) 255-7900

**OWNER'S AGENT**

Owner's Agent's Name: \_\_\_\_\_

Address (including zipcode): \_\_\_\_\_

E-mail address: \_\_\_\_\_

Phone number: \_\_\_\_\_ Fax number: \_\_\_\_\_

**PROJECT ENGINEER**

Company name: \_\_\_\_\_

Representative: \_\_\_\_\_

Address (including zipcode): \_\_\_\_\_

Phone number: \_\_\_\_\_ Fax number: \_\_\_\_\_

E-mail address: \_\_\_\_\_

**PROJECT INFORMATION**

PROPOSED PROJECT NAME: IP/BLOCK PROPERTY CORNER

PROPOSED PROJECT ADDRESS (INCLUDING ZIPCODE): \_\_\_\_\_

OWNER OF PROPOSED USAGE AREA: \_\_\_\_\_

TAX IDENTIFICATION NUMBER OF PROPOSED USAGE AREA: \_\_\_\_\_

LOCATION OF PROPOSED USE:  
Section: 18 Township: 2S Range: 24E County: DUNAL

Nearest intersection: \_\_\_\_\_

Have you had contact with a JEA representative regarding this project?  
Yes X No \_\_\_\_\_ If so, with whom?



JEA representative's name: BRANDON TRAUB

Department: REAL ESTATE Phone: (386) 689-5151

DESCRIPTION OF PROPOSED USE (Attach additional page, if needed): C.O.T  
IS REQUESTING APPROXIMATELY 0.13 ACRES TO BE  
ABLE TO ACCESS THE IP PROPERTY FROM THE BLOCK  
PROPERTY AND VICE VERSA, FOR MAINTENANCE  
PURPOSES

**ATTACHMENTS(MUST BE INCLUDED):**

- General Location Map
- Tax identification Map
- Legal description of the impacted area.
- Drawing of Proposed Utilization

**Applicant declares that prior to filing this application it has ascertained the location of all existing utilities, both overhead and underground and has illustrated said locations on the attached drawing.**

  
Applicant Signature

6-14-22  
Date

For JEA use only: Date: _____ Approved: _____ Denied: _____ Reason, if denied: _____
Type of Agreement: _____
JEA Contact Person: _____
Phone: _____
Comments/Follow-up: _____
_____
_____

# **APPENDIX E**

## **Examples, Interlocal Agreements for Joint Use of Property**

**Texas Utilities Electric Company**  
**City of Richardson, Dallas County, TX**

File: Owens Trail  
Legal

W. Plano - E. Richardson  
Deed No.'s 2474 & 2935  
JLT

COMMERCIAL  
LICENSE AGREEMENT

STATE OF TEXAS       §  
                                  §  
COUNTY OF DALLAS   §

KNOW ALL MEN BY THESE PRESENTS:

This license agreement made this 1st day of April, 1996, by and between Texas Utilities Electric Company, a Texas Corporation, hereinafter called Licensor and the City of Richardson, Dallas County, Texas hereinafter called Licensee. In consideration of the mutual covenants and agreements set forth herein, and other good and valuable consideration, Licensor does hereby grant to Licensee, a revocable nonexclusive license to use the following described property:

SEE EXHIBIT "A" ATTACHED

1.     **LICENSE TERM:** The term of this license shall be for 10 years commencing on April 1st, 1996 and ending on April 1st, 2006, and shall continue thereafter on a 1 year to 1 year basis until terminated by either party with thirty days written notice.
  
2.     **RENTAL FEE:** Licensee agrees to pay Licensor the sum of \$0.00 dollars per year as a fixed rent. The \$0.00 dollar rental fee is subject to revision no more often than every three years. Licensor shall notify Licensee of any increase ninety days before it will become effective. Licensee may terminate the license by written notice at least forty-five days prior to that rental increase effective date.
  
3.     **PERMITTED USE:** Licensee may use the premises to install a "Multi - Use Trail" for the City of Richardson. Licensee may not use the premises for any other purpose without the written consent of Licensor.
  
4.     **LIABILITY INSURANCE:** During the license term Licensee shall maintain a policy of public liability insurance at Licensee's expense insuring Licensee against liability assumed by Licensee hereunder and insuring Licensee and Licensor against liability arising out of or in any way incident to ownership, use, occupancy or maintenance of the property made the subject of this license. Such policy or policies shall also provide that the policy is primary and shall apply without regard to other policies separately carried. The initial amount of required insurance shall be at least \$1,000,000 Combined Single Limit for Personal Injury, Bodily Injury including death and Property Damage and shall be subject to periodic increase based upon inflation, recommendation of professional insurance advisors, and other relevant factors. Licensor shall give Licensee ninety days notice of any change in insurance requirements Licensee agrees to obtain and provide proof of such required insurance.

5. INDEMNITY: Licensee agrees to defend, indemnify, and hold Licensor, its officers, agents and employees, harmless against any and all claims, lawsuits, judgments costs, and expenses for personal injury (including death), property damage or other harm for which recovery of damages is sought, suffered by any person or persons that may arise out of or be occasioned by any negligent act or omission of Licensee, its officers, agents, associates, employees, or subconsultants; except that the indemnity provided for in this paragraph shall not apply to any liability resulting from the sole negligence of Licensor, its officers, agents, or employees or separate contractors, and in the event of joint and concurrent negligence of both the Licensee and Licensor, responsibility and indemnity, if any, shall be apportioned comparatively in accordance with the laws of the State of Texas, without, however, waiving any governmental immunity or other defenses available to the parties under Texas law. The provisions of this paragraph are solely for the benefit of the parties hereto and not intended to create or grant any rights, contractual or otherwise, to any other person or entity.
6. COMPLIANCE WITH LAW: Licensee shall, at its own cost and expense, comply with all applicable laws, including but not limited to existing zoning ordinances, governmental rules and regulations enacted or promulgated by any governmental authority and shall promptly execute and fulfill all orders and requirements imposed by such governmental authorities for the correction, prevention and abatement of nuisances in or upon or connected with said premises because of Licensee's use thereof.
7. LICENSOR'S ACCESS: Licensor and its authorized agents shall have the right to enter the property at any time for any purpose. It being understood that from time to time entry will be necessary for general inspections of Licensor's facilities. This license is nonexclusive, and Licensor, its employees, agents, representatives, and others whom it may license, may go upon, make improvements upon, use and traverse the above described premises and make changes in the location of or additions to Licensor's transmission and distribution facilities located thereon without payment of compensation to Licensee, without liability for any damage or interruption resulting to Licensee of its activities or business.
8. ACCEPTANCE OF PREMISES: Licensee acknowledges that it has fully inspected the property and accepts the property in its present condition as suitable for the purposes for which it is licensed. Licensee shall not make or cause to be made any improvements to the licensed property including but not limited to, any buildings, light standards, fences, shrubs, trees or signs, except as approved in writing by Licensor and then only at the sole cost and expense of Licensee.
9. CONDITION UPON TERMINATION: Upon termination of this agreement, Licensee shall surrender the property to Licensor in the same condition as received except for ordinary wear and tear. In addition, Licensor may require Licensee to remove any improvements made to the property by Licensee prior to the termination of this agreement and to restore the property to its original condition, at Licensee's expense. All improvements not removed at Licensor's request, shall become Licensor's property at no cost or expense to Licensor.

10. ASSIGNMENT AND SUBLETTING: This agreement is personal to Licensee and may not be sold, transferred, assigned or sublet but may be used by Licensee, and with Licensee's permission, by its employees, agents and those with whom it does business.
11. BOOM-TYPE EQUIPMENT: Use of draglines or other boom-type equipment in connection with any work to be performed on Licensor's property by the Licensee, its employees, agents, representatives or contractors must comply with Chapter 752, Texas Health and Safety Code, the National Electric Safety Code and any other clearance requirements. Notwithstanding anything to the contrary herein, in no event shall any equipment be within fifteen feet of Licensor's power lines situated on the aforesaid property. Licensee must notify the Supervisor of Dallas Region Transmissions Operations at (214) 721-6281 48 hours prior to the use of any boom-type equipment on Licensor's property. Licensor reserves the right to refuse Licensee permission to use boom type equipment.
12. LIEN ON PROPERTY: During the period of construction and at all times while this agreement is in effect, Licensee shall take whatever steps are necessary to prevent any liens, including but not limited to, mechanics liens and materialmen's liens, from attaching to Licensor's property. Licensee shall immediately pay such sums as may be necessary to dispatch liens and encumbrances filed with respect to all or any portion of the Licensor's property resulting from the construction, maintenance or presence of any of Licensee's improvements.
13. MAINTENANCE OF PROPERTY: Licensee, at its own cost and expense at all times during the term of this agreement, agrees to keep clean and maintain or cause to be kept clean and maintained, the premises and all improvements which may be placed or erected on the premises by Licensee with Licensor's consent in a good state of appearance and repair.
14. NOTICES: All written notices required under this License must be hand delivered or sent by certified mail addressed to the proper party at the following addresses:

LICENSOR

Texas Utilities Electric Company  
Energy Plaza (EP-34126)  
1601 Bryan Street  
Dallas, Texas 75201-3411

LICENSEE

City of Richardson  
Attn: Mr. Al Johnson  
P. O. Box 830309  
Richardson, Texas 75083-0309

Each party may change the address to which notices are to be sent by giving the other party notice, within ten (10) days, of the new address in the manner provided by this paragraph.

15. DEFAULT: It is understood and agreed that, in case of default by Licensee in any of the terms and conditions herein stated and such default continues for a period of ten (10) days after Licensor notifies Licensee of such default, Licensor may at its election forthwith terminate this agreement and upon such termination all rights of the Licensee hereunder shall cease and come to an end. If such termination results from Licensee's default there shall be no prorata refund to Licensee of the unearned portion of the rental fee for the then current term, however, in the event that termination of this agreement is for the convenience of either or both parties hereto, Licensor shall refund to Licensee the prorated portion of the rental fee for the then current term.
16. BARRICADES: Licensee will construct, at Licensee's expense, barricades around any transmission tower structures and/or any distribution poles as required and approved by Licensor. Licensee shall install said barricades before any other construction work is begun and before using the premises for the purposes set forth herein.
17. PRIOR AGREEMENTS: This agreement constitutes the sole and only agreement of the parties to the license and supersedes any prior understandings or written or oral agreements between the parties respecting the subject matter of this license.
18. ADDITIONAL PROVISIONS: Licensor reserves the right to construct, reconstruct, remove, maintain and operate any all electric power transmission and distribution lines, or any other facilities which it deems necessary or desirable in the conduct of its business on, over, across, along and under the licensed property, and shall not be liable to Licensee for any damages, including loss of use or damage to or destruction of Licensee's improvements on the licensed property caused thereby. Any TU Electric property damaged or destroyed by Licensee or its agents shall be repaired or replaced by TU Electric at Licensee expense and payment is due upon Licensee's receipt of an invoice from TU Electric.
18. TEXAS LAW: This agreement shall be construed under, and in accordance with, the laws of the State of Texas.
19. AMENDMENT: No amendment, modification, or alteration of the terms of this license shall be binding unless it is in writing, dated subsequent to this lease, and duly executed by the parties to this license.

EXECUTED in duplicate as of the \_\_\_\_\_ day of \_\_\_\_\_, 1996.

LICENSOR:

TEXAS UTILITIES ELECTRIC COMPANY

BY: \_\_\_\_\_

M. J. Thomason  
Manager, Dallas Region Transmission

STATE OF TEXAS       §  
                                  §  
COUNTY OF DALLAS   §

BEFORE ME, the undersigned authority, on this day personally appeared M. J. Thomason, Manager of Dallas Region Transmission, for Texas Utilities Electric Company, known to me to be the person whose name is subscribed to the foregoing instrument and acknowledged to me that he executed the same as the act and deed of the said Texas Utilities Electric Company, and for the purposes and consideration therein expressed and in the capacity therein stated, and that he was authorized to do so.

GIVEN UNDER MY HAND AND SEAL OF OFFICE, this \_\_\_\_\_ day of \_\_\_\_\_, A.D., 1996.

\_\_\_\_\_  
Notary Public in and for the State of Texas

\_\_\_\_\_  
(Print Name of Notary Public Here)



LICENSEE:

CITY OF RICHARDSON

BY:

*Jerry Hiebert*

Jerry Hiebert

TITLE: Deputy City Manager

STATE OF TEXAS §

§

COUNTY OF DALLAS §

BEFORE ME, the undersigned authority, on this day personally appeared Jerry Hiebert, known to me to be the person whose name is subscribed to the foregoing instrument and acknowledged to me that he/she executed the same as the act and deed of City of Richardson, as the Deputy City Manager thereof, and for the purposes and consideration therein expressed and in the capacity therein stated, and that he was authorized to do so.

GIVEN UNDER MY HAND AND SEAL OF OFFICE this 16 day of May, A.D. 1996.



*Eileen Hanson*  
Notary Public in and for the State of Texas  
Notary Public, State of Texas  
My Commission Expires  
02/13/99

(Print Name of Notary Public Here)

FILE COPY

Legal - Owens Tr.  
TU Elec

ENCROACHMENT ON EASEMENT

W Plano-E Rich.  
Request # 96011  
JLT

March 19, 1996

City of Richardson  
Attn: Mr. Al Johnson  
P. O. Box 830309  
Richardson, Texas 75083-0309

1360353

07/12/96  
Deed 114016 \$23.00

Re: West Plano to East Richardson to Spring Valley Transmission Line  
E - 127804, E - 130128 & E - 138191

Dear Mr. Johnson:

The City of Richardson, (hereinafter referred to as User) has requested permission to construct a "Multi - Use Trail" within the area or boundaries of Texas Utilities Electric Company's, a Texas corporation ("TU Electric"), successor to Texas Power & Light Company, easements recorded in Volume 5737, Page 388; Volume 5934, Page 42; and Volume 529, Page 18, Deed Records of Dallas County, Texas.

TU Electric is agreeable to the construction of the "Multi - Use Trail", hereinafter referred to as the "encroaching facility", if the encroaching facility is located and described as shown on the attached drawing, marked Exhibit "A" and incorporated herein, and subject to the following terms and conditions:

1. It is understood and agreed that TU Electric holds easement rights on the property involved; therefore, User will be required to obtain whatever rights and permission, other than TU Electric's, that are necessary. This letter agreement shall extend to and be binding upon User and its heirs, successors, and assigns, and is not to be interpreted as a waiver of any rights held by TU Electric under its easement.
2. User agrees to defend, indemnify, and hold licensor, its officers, agents and employees, harmless against any and all claims, lawsuits, judgments cost, and expenses for personal injury (including death), property damage or other harm for which recovery of damages is sought, suffered by any person or persons that may arise out of or be occasioned by any negligent act or omission of User, its officers, agents, associates, employees, or subconsultants; except that the indemnity provided for in this paragraph shall not apply to any liability resulting from the sole negligence of TU Electric, its officers, agents, or employees or separate contractors, and in the event of joint and concurrent negligence of both the User and TU Electric, responsibility and indemnity, if any, shall be apportioned

8-6-96 Original to Ina Garber, City Secretary  
A

96136 01588

be apportioned comparatively in accordance with the laws of the State of Texas, without, however, waiving any governmental immunity or other defenses available to the parties under Texas law. The provisions of this paragraph are solely for the benefit of the parties hereto and not intended to create or grant any rights, contractual or otherwise, to any other person or entity.

3. Use of draglines or other boom-type equipment in connection with any work to be performed on the TU Electric easement by User, its employees, agents, representatives or contractors must comply with Chapter 752, Texas Health and Safety Code, the National Electrical and any other applicable safety or clearance requirements. Notwithstanding anything to the contrary herein, in no event shall any equipment be within fifteen (15) feet of the TU Electric power lines situated on the aforesaid property. User must notify the Supervisor of Dallas Region Transmission Operations at (214) 721-6281, 48 hours prior to the use of any boom-type equipment on the TU Electric easement. No trenching will be allowed within twenty-five (25) feet of any tower structure leg without contacting the Dallas Region Transmission Operations Department at (214) 721-6281.
4. The encroaching facility does not currently interfere with TU Electric's usage, but if in the future the encroaching facility, in the sole judgment of TU Electric, does interfere with the use or enjoyment of its easement rights, TU Electric shall have the right to remove said encroaching facility. TU Electric shall notify User in writing that within 90 days, the encroaching facility must be removed at User's sole cost. If at the end of the 90 day period the encroaching facility has not been removed, TU Electric shall remove it at User's expense. TU Electric will not be responsible nor will compensation be paid for damages incurred by such removal. However, in an emergency, TU Electric shall have the right to immediately remove the encroaching facility. If the encroaching facility is removed, TU Electric will not unreasonably withhold consent for User to relocate the encroaching facility within the easement.
5. It is expressly understood and agreed that if the property has transmission or distribution facilities located thereon, User shall not place upon the premises, any improvements including but not limited to, buildings, light standards, fences, shrubs, trees or signs unless approved in writing by TU Electric.
6. It is agreed that no trash dumpsters, toxic substances or flammable material will be allowed on the easement.
7. TU Electric will not be responsible for any costs of construction, operation or maintenance of User's encroaching facility. It is further agreed that TU Electric shall not be liable for any damage to the encroaching facility herein agreed to as a result of TU Electric's use pursuant to its easement. Any TU Electric property damaged or destroyed by User or its agents shall be repaired or replaced by TU Electric at User's expense and payment is due upon User's receipt of an invoice from TU Electric.

8. User will construct, at User's expense, barricades around any transmission tower structures and/or any distribution poles as required and approved by TU Electric. User shall install said barricades before any other construction work is begun and before using the premises for the purposes set forth herein.
9. It is understood and agreed that, in case of default by User or its agents in any of the terms and conditions herein stated and such default continues for a period of ten (10) days after TU Electric notifies User of such default, TU Electric may at its election forthwith terminate this agreement and upon such termination all of User's rights hereunder shall cease and come to an end. This agreement shall also terminate upon the abandonment of the encroaching facility.

If the foregoing terms and conditions are acceptable to the "City of Richardson", please have the original and a copy of this letter agreement signed and returned to me at Energy Plaza, 1601 Bryan Street, Suite 34-126, Dallas, Texas 75201-3411, within 30 days for final approval by TU Electric. This letter agreement shall be effective only after final approval by TU Electric.

Sincerely,

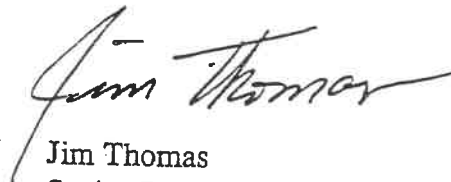

Jim Thomas  
Senior Real Estate Analyst

APPROVED:

TEXAS UTILITIES ELECTRIC COMPANY

By: *M. J. Thomason*

M. J. Thomason  
Manger of Dallas Region Transmission

STATE OF TEXAS §  
  §  
COUNTY OF DALLAS §

BEFORE ME, the undersigned authority, on this day personally appeared M. J. Thomason, Manager of Dallas Region Transmission, of Texas Utilities Electric Company, known to me to be the person whose name is subscribed to the foregoing instrument and acknowledged to me that he executed the same as the act and deed of the said Texas Utilities Electric Company, and for the purposes and consideration therein expressed and in the capacity therein stated, and that he was authorized to do so.

GIVEN UNDER MY HAND AND SEAL OF OFFICE, this 30th day of May, A.D., 1996.



*Linda Hampton*  
Notary Public in and for the State of Texas

LINDA HAMPTON  
(Print Name of Notary Public Here)

ACCEPTED:

CITY OF RICHARDSON

By: *Jerry Hiebert*  
Jerry Hiebert

Title: Deputy City Manager

STATE OF TEXAS       §  
                                  §  
COUNTY OF DALLAS   §

BEFORE ME, the undersigned authority, on this day personally appeared Jerry Hiebert, known to me to be the person whose name is subscribed to the foregoing instrument and acknowledged to me that he/she executed the same as the act and deed of City of Richardson, as the Deputy City Manager thereof, and for the purposes and consideration therein expressed and in the capacity therein stated, and that he was authorized to do so.

GIVEN UNDER MY HAND AND SEAL OF OFFICE this 16 day of May, A.D. 1996.

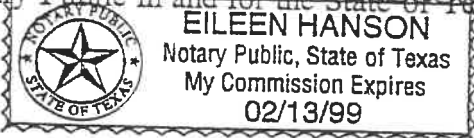
*Eileen Hanson*  
Notary Public in and for the State of Texas  

(Print Name of Notary Public Here)

Exhibit "A"

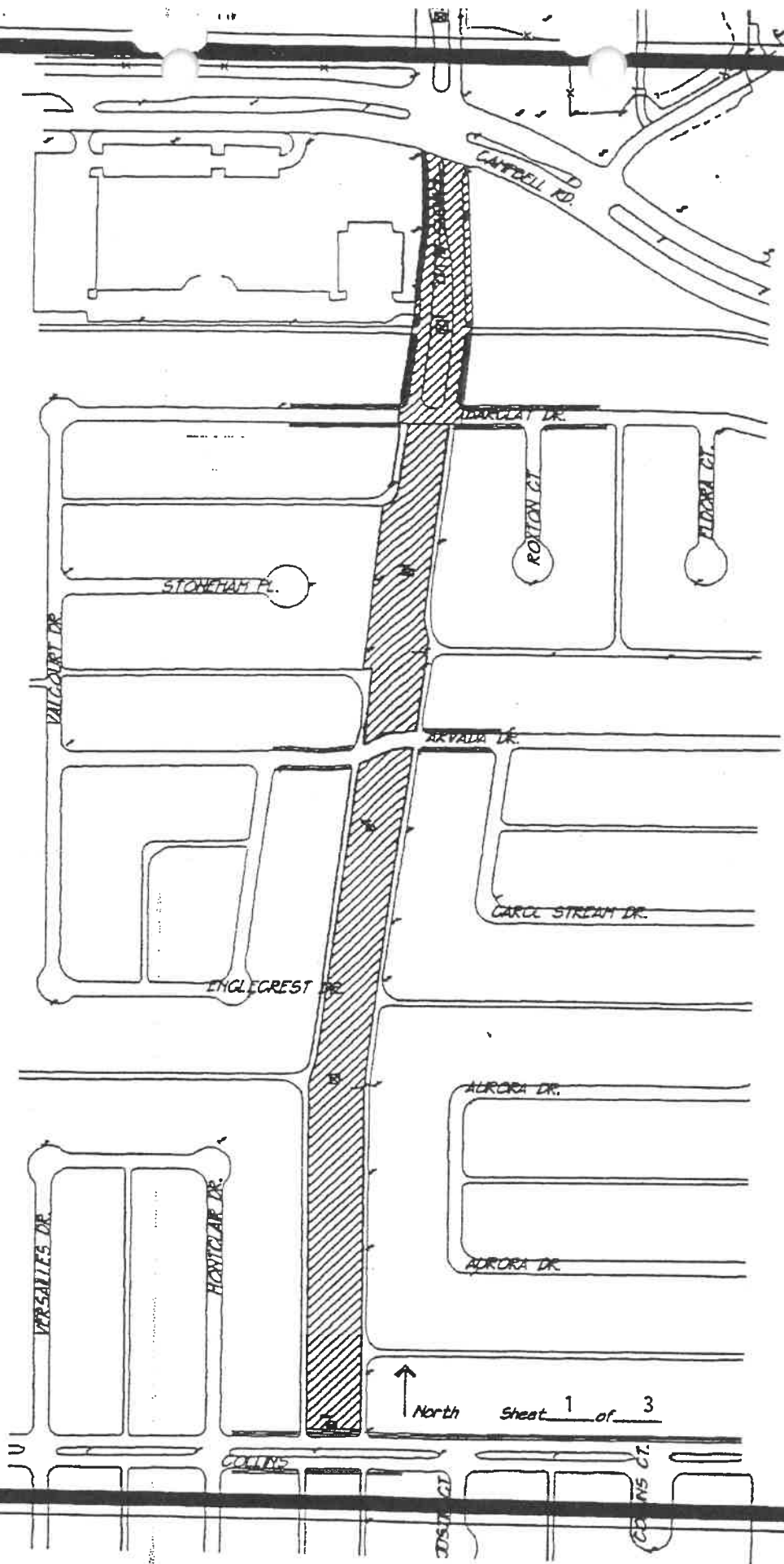

96136 01593

Exhibit "A"

E. ARAPAHO RD.

WILLOW CREST

MEADOWGATE

FAIR OAKS

PIPER CIR.

ALLISON

AUBURN DR.



North

Sheet 2 of 3

BROOK MEADOW DR.

WOODHILL DR.

DRAY DR.

TULANE DR.

96136 01594



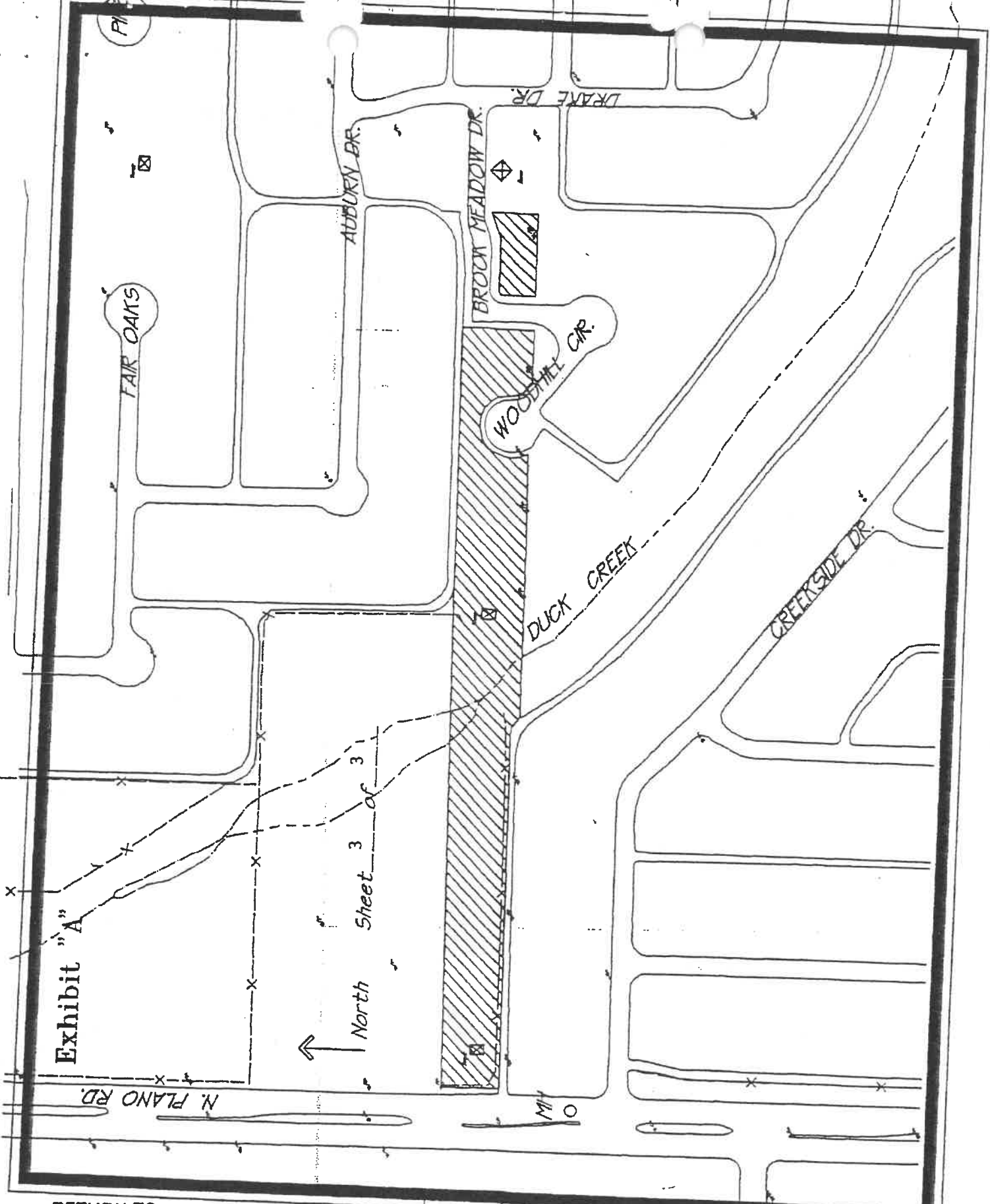

RETURN TO:  
 J. R. FRANCISCO  
 REAL ESTATE & RIGHT OF WAY DEPT.  
 TEXAS UTILITIES SERVICES, INC.  
 1601 BRYAN  
 DALLAS, TX 75201

96136 01595

FILED

96 JUL 12 AM 9:02

EARL BULLOCK  
COUNTY CLERK  
DALLAS COUNTY

Any provision herein which restricts the sale, rental, or use of the described real property because of color or race is invalid and unenforceable under federal law.  
I hereby certify this instrument was filed on the date and time stamped herein by me and was duly recorded in the public and Page of the named records of Dallas County, Texas as stamped hereon by me.

STATE OF TEXAS

COUNTY OF DALLAS

JUL 12 1996



*Earl Bullock*  
COUNTY CLERK, Dallas County, Texas

**Duke Energy**

**City of Debary, Volusia County, FL**

This document jointly prepared by the Parties Involved

Return to:

Attn:

### TRAIL AGREEMENT

THIS TRAIL AGREEMENT (this "AGREEMENT"), made this 19<sup>th</sup> day of May 2020 by and between DUKE ENERGY FLORIDA, LLC a Florida Limited Liability Company d/b/a Duke Energy (hereinafter referred to as "DUKE ENERGY"), the County of Volusia, a political subdivision of the State of Florida (hereinafter referred to as "COUNTY"), and the City of DeBary, a Florida Municipal Corporation (hereinafter referred to as "CITY"), and collectively referred to herein as the "PARTIES," as the for the construction of Phase 3B of the Spring to Spring Trail (hereinafter referred to as the "Trail");

### WITNESSETH:

WHEREAS, the COUNTY and CITY desire to construct, operate and maintain an approximately 2.9 mile public multi-use trail from Rob Sullivan Park to Highway 17/92 in the CITY, as depicted within the Overall depiction of the trail project enclosed attached as Exhibit A, and by this reference incorporated herein and made a part hereof); and

WHEREAS, DUKE ENERGY is the owner of the fee simple title to certain lands that serve as DUKE ENERGY's electric production plant, substation, and power lines in the County of Volusia and State of Florida as evidenced by an individual deed of conveyance appearing respectively among the Public Records of County of Volusia, Florida, and cited for reference on the tabulation attached hereto as Exhibit B, hereinafter referred to as the Properties and by this reference incorporated herein and made a part hereof; and

WHEREAS, DUKE ENERGY is also the owner, possessor and user of specific easement rights over, upon and across certain lands and likewise presently serving as right-of-way corridors for DUKE ENERGY's said network of electric transmission and distribution lines in the county of Volusia and State of Florida as evidenced by individual easement documents appearing respectively among the Public Records of Volusia County, Florida and cited for reference on tabulation attached hereto as Exhibit B and by this reference incorporated herein and made a part hereof; and

WHEREAS, the above-cited deeds of conveyance or easement documents, which shall be referred to hereinafter collectively as DUKE ENERGY's Property, afford DUKE ENERGY the right, by appropriate legal means, to restrict any use of the said right-of-way corridors which is inconsistent with the safe and efficient construction, reconstruction, operation or maintenance of DUKE ENERGY's existing or future facilities therein; and

WHEREAS, COUNTY and CITY desire to occupy and utilize a portion of said Property for the purposes of constructing and utilizing a multi-use trail as generally shown in the construction plans dated September 25, 2019, herein referred to as Exhibit E (sometimes referred to herein as "COUNTY's Utilization" or "CITY's Utilization) which utilization shall not interfere with DUKE ENERGY's continued operation and maintenance of DUKE ENERGY's current and future high voltage electric transmission and distribution lines located thereon; and

WHEREAS, this AGREEMENT is for the purpose of recognizing the COUNTY's and CITY's Utilization of DUKE ENERGY'S Property as a multi-use trail for the public, and to provide for cooperation and access during the construction, use and maintenance of said Trail; and

WHEREAS, DUKE ENERGY is willing to grant to COUNTY and CITY the desired occupancy and utilization, subject to certain terms and conditions; and

WHEREAS, the Trail will traverse through the CITY; and

WHEREAS, a portion of the Trail will be constructed in an already existing CITY trail easement, within CITY Right of Way (ROW) , and on City Property; and

WHEREAS, the CITY agrees that this AGREEMENT shall grant the COUNTY authority to construct the multi-use trail within the CITY's easement, ROW, and CITY Property and serve as the use permit for said construction; and

WHEREAS, at the conclusion of construction of the Trail by the COUNTY, the CITY shall take over maintenance and operation of the Trail, subject to the terms and conditions herein.

NOW, THEREFORE, for and in consideration of the benefits herein provided, the receipt and sufficiency of which is hereby acknowledged, the parties hereby agree as follows:

The above recitals are incorporated herein as if set forth herein.

1. DUKE RESPONSIBILITIES.

- A. DUKE ENERGY hereby authorizes COUNTY to construct a twelve (12) foot wide multi-use Trail over those portions of DUKE ENERGY's Property as depicted in Exhibit A and described in Exhibit C which is attached and incorporated herein, which has been reviewed and approved by DUKE ENERGY. For purposes of this Agreement, the term Trail shall also be deemed to mean the Multi Use Paths or Shared Use Paths as defined by AASHTO (American Association of State Highway and Transportation Officials).
- B. DUKE ENERGY will not be held responsible for any damages to the Trail due to DUKE ENERGY's operations or for any liability based on the use of the Trail. DUKE ENERGY shall not be liable for any damages to the COUNTY's or CITY's Utilization or operation of the Trail whatsoever resulting from DUKE ENERGY's continued use and occupancy of DUKE ENERGY's Property with the understanding that DUKE ENERGY shall not willfully cause damage to or unreasonably interfere with the COUNTY's or CITY's Utilization. DUKE ENERGY agrees to notify the COUNTY or CITY immediately if it inadvertently damages any of the Trail or COUNTY's or CITY's property while maintaining DUKE ENERGY's infrastructure, and further agrees to take steps to temporarily ensure that said damaged area is properly identified and secured from public access.

- C. DUKE ENERGY reserves the right to close, without notice, all or a portion of the Trail located within DUKE ENERGY'S Property, for any length of time, for construction, maintenance or emergency line operations. DUKE ENERGY will give the COUNTY during construction, and the CITY after Trail construction, reasonable notice of such closure so that COUNTY or CITY can place signs prior to the closed area to secure the area from public access.

2. COUNTY RESPONSIBILITIES.

- A. The COUNTY, shall at its costs and expense, construct the Trail as depicted in Exhibit A and as described in Exhibit C. All services and work under the construction contract for the Trail shall be performed to the satisfaction of the County Engineer and in accordance with the terms and conditions of this AGREEMENT.
- B. Compliance with conditions specified in Duke's Electric Transmission Right-of-Way Requirements for Shared-Use Trails presented in Exhibit D is necessary and essential to render the COUNTY's and CITY's Utilization of DUKE ENERGY's Property consistent with DUKE ENERGY's continued operation and maintenance needs of DUKE ENERGY's high voltage electric transmission and distribution lines and electric substation located thereon. Any breach of the requirements and conditions in Exhibit D that is not approved as part of this agreement or without prior written approval by DUKE ENERGY shall permit DUKE ENERGY to be able to shut the Trail down without liability to the COUNTY during construction or the CITY after construction of the Trail until the condition or requirement is remedied to comply with Exhibit D.
- C. As consideration for DUKE ENERGY's authorization to utilize DUKE ENERGY's Property as a Trail, COUNTY agrees to pay DUKE ENERGY the fair market value for the right to use the real property for a public trail as depicted in Exhibit A and described in Exhibit C, as determined by an independent real estate appraiser mutually agreed upon by DUKE ENERGY and COUNTY and provide a current plan of the proposed trail. COUNTY shall pay for the cost of the preparation of the appraisal report and survey and pay DUKE ENERGY the amount of money as determined by said appraiser to constitute the fair market value of the subject property within sixty (60) days of completion of said appraisal report, copies of which shall be provided to both DUKE ENERGY and COUNTY.
- D. All of COUNTY's activities, operations, and equipment required to construct the trail as presented in the County Construction Plans, attached hereto as Exhibit E and incorporated herein by reference, and located within the properties or easements listed in Exhibit B used within the Trail beneath or in proximity to any DUKE ENERGY's facilities shall at all times be in strict compliance with the applicable provisions of National Electrical Safety Code, the Occupational Safety and Health Administration, and all Federal, State and Local Requirements as reviewed and approved by Duke Energy.
- F. The Trail must not exceed a total of twelve (12') feet in width. However, DUKE ENERGY recognizes that in order to construct the Trail, an area up to thirty (30) foot wide may be

cleared and temporarily impacted at certain locations on DUKE ENERGY's Property. A minimum separation of twenty-five (25') feet is required between the Trail and any DUKE ENERGY electrical support structures or related facility. This includes, but is not limited to, poles, towers, guy anchor(s), and equipment, but does not include typical distribution poles. DUKE hereby grants a variance for the three (3) locations identified in Exhibit F whereby the minimum separation of twenty-five (25') feet is not possible. However, the minimum separation in those locations shall be no less than twenty (20') feet.

- G. The COUNTY during construction shall be responsible for safety and liability associated with the construction of the Trail.
- H. County, at County expense, will reinforce the Trail from station 37+50 to 50+00, 67+40 to 71+60, 108+00 to 121+40, and 131+20 to 141+20 as indicated in Exhibit E along the corridor for DUKE ENERGY heavy equipment crossings. These Trail reinforcement areas shall be capable of supporting a maximum gross vehicle weight of 80,000 lbs.
- I. Other than DUKE ENERGY's facilities, and those approved and shown on the construction plans for the Trail presented in Exhibit E within DUKE ENERGY's Property, no structures including, but not limited to, lights, signs (except for the notices and signage as depicted in Exhibit E), benches, exercise equipment, irrigation systems, overhead wires, poles, light standards, dumpsters, trees, buildings, obstacles or other facilities shall be located, constructed or installed within DUKE ENERGY's Property.
- J. Planting of vegetation shall adhere to the Right of Way Restrictions Guidelines for the specific DUKE ENERGY territory. There shall be no planting of any new vegetation on or along the Trail without DUKE ENERGY'S prior written consent except for sodding of disturbed areas.
- K. COUNTY agrees that it will repair, at its sole costs, any damage that DUKE ENERGY may cause to the Trail during construction.
- L. COUNTY acknowledges that its use of the Trail or DUKE ENERGY's Property shall be at COUNTY's sole risk and expense. DUKE ENERGY shall in no way be liable to COUNTY or any third party for any costs, expenses, losses, damages, or liabilities incurred by COUNTY or any third party in its use of DUKE ENERGY's Property. The COUNTY expressly retains all rights, benefits and immunities of sovereign immunity in accordance with Section 768.28, Florida Statutes. Each party shall be liable for its own actions and negligence. Notwithstanding anything set forth in any section of this Agreement to the contrary, nothing in this Agreement shall be deemed as a waiver of immunity or limits of liability of any party beyond any statutory limited waiver of immunity or limits of liability which may have been adopted by the Florida Legislature, or may be adopted by the Florida Legislature, and liability of any party for damages shall not exceed the statutory limits of liability, regardless of the number or nature of any claim which may arise, including, but not limited to, a claim sounding in tort, equity or contract.

- M. COUNTY is self-insured for its worker's compensation, automobile, and general liability exposures. COUNTY shall provide a statement of self-insurance from COUNTY's Risk Manager upon execution of this Agreement and upon request. COUNTY shall agree to indemnify DUKE ENERGY for the sole negligence of COUNTY and its employees, subject to the statutory caps for damages and limitations as to liability set forth in Section 768.28, Florida Statutes. Nothing in this Agreement shall be deemed as a waiver of immunity or limits of liability of the COUNTY beyond any statutory limited waiver of immunity or limits of liability, which may have been or may be adopted by the Florida Legislature, and the cap on the amount and liability of COUNTY for damages, regardless of the number or nature of claims or whether in tort, equity, or contract, shall not exceed the dollar amounts set by the legislature for tort claims. Nothing in this Agreement shall inure to the benefit of any third party for the purpose of allowing any claim against COUNTY, which would otherwise be barred under the doctrine of sovereign immunity or by operation of law.
- N. Duke Energy Electric Transmission right-of-way Requirements for Shared-use Path/Trails, Exhibit D, shall apply to the construction and maintenance of this Trail unless otherwise approved or modified in this agreement or as approved in the existing plans, Exhibit E.
- O. COUNTY shall adhere to applicable regulatory provisions regarding clearances between ground level and electric conductors as reviewed and approved by DUKE ENERGY. DUKE ENERGY's Property contains high voltage power lines. Extreme caution must be used when working within the Trail and within DUKE ENERGY's Property.
- P. The area within DUKE ENERGY's Property which is disturbed by the COUNTY's Utilization during construction, shall be restored by the COUNTY to a condition at least as good as that which existed prior to construction.
- Q. A DUKE ENERGY approved Inspector will be assigned to verify that construction of the Trail within or on DUKE ENERGY's Property or easements listed in Exhibit B is in compliance with the terms and conditions of the AGREEMENT. All costs of DUKE ENERGY's Inspector are to be paid by the COUNTY. DUKE ENERGY's Inspector shall be notified fourteen (14) days prior to the commencement of construction within DUKE ENERGY's right-of-way and/or easement. During construction, the COUNTY's Construction Manager (or designated representative) will make reports to DUKE ENERGY's Inspector regarding any damages to DUKE ENERGY's Property, private property or other public facilities. During construction, COUNTY agrees to pay all expenses incurred in connection with the repair of such damages.
- R. The COUNTY during construction shall be responsible for clean-up of any and all hazardous material spills resulting from the COUNTY's Utilization which may occur within DUKE ENERGY's Property. If a hazardous material spill occurs during Trail



construction, the COUNTY shall immediately report the nature and extent of the spill to DUKE ENERGY's nearest local office.

- S. COUNTY during construction agrees that no burning, refueling or stockpiling of dirt or other materials are allowed within DUKE ENERGY's Property.
- T. COUNTY agrees to furnish DUKE ENERGY's Asset Protection Specialist with a set of as-built drawings of the COUNTY's utilization area within ninety (90') days of completion of construction, noting the location of the COUNTY's improvements within DUKE ENERGY's Property and DUKE ENERGY's nearest structures.
- U. DUKE ENERGY's Asset Protection Specialist shall be notified by COUNTY at least fourteen (14) days prior to COUNTY's commencement of initial construction activities within DUKE ENERGY's Property.
- V. Upon completion of Trail construction, the COUNTY ENGINEER shall execute Exhibit G to provide notice to the CITY that the Trail construction is complete and the CITY shall have the right to inspect and approve the Trail construction. From the date of the CITY's acceptance of the Trail construction, the CITY is responsible the operation and maintenance responsibilities of the Trail until the termination of this AGREEMENT. This AGREEMENT shall also serve as COUNTY's permission for the CITY to access, operate and use all easements obtained for the Trail for maintenance and operation of the Trail by the CITY. COUNTY represents that the public has the right of use of the easements that COUNTY assigns and grants use rights to the CITY concerning the Trail. The COUNTY shall not require the CITY to obtain additional COUNTY approvals or permits outside this AGREEMENT to operate or maintain the Trail or for the public's use thereof.
- W. Culverts shall be installed where the Trail crosses creeks, ditches, or depressions that may carry water. These culverts shall be Class IV Reinforced Concrete Pipe per ASTM C76 / AASHTO M 170 (with an Ultimate D-Load of 3000 lbs/ft/ft) and shall be a minimum of twenty (20) feet long. Signage must indicate the maximum load of the crossing at culvert approach.

3. CITY RESPONSIBILITIES

- A. Upon execution of this Agreement, the CITY hereby grants permission for the COUNTY to construct the Trail within the CITY's easements, Right-of-Ways, and Properties as depicted in Exhibit A and D and shall not require the COUNTY to obtain additional approvals or permits outside this AGREEMENT. This AGREEMENT shall also provide permission for the COUNTY to use the CITY's Trail easement after construction for maintenance or repair of the Trail should the CITY fail to maintain the Trail under the terms of this AGREEMENT.

- B. After the COUNTY's construction of the Trail and the CITY's acceptance of the Trail, the CITY shall be responsible for safety and liability as may be imposed by law associated with the operation, maintenance, and use of the Trail in compliance with Exhibit H of the State-Funded Grant Agreement FPN No. 439039-3-54-01 with FDOT. Additionally, the CITY shall be responsible for cleanup as well as removal and disposal of all debris and trash within the Trail after construction is complete. CITY shall be responsible for maintaining the Trail in a condition compatible with the surrounding area.
- C. The CITY hereby agrees to notify any of the CITY's employees, agents, contractors, representatives, or other persons maintaining the Trail and further agrees to post notices along the Trail to notify the Public and all persons engaging in CITY's activities within said DUKE ENERGY's Property, that extreme caution is necessary around all of DUKE ENERGY's electrical facilities, supporting structures, anchor guys or related appurtenances, and in the event of any damages or injuries, the CITY shall immediately report the nature and extent thereof to DUKE ENERGY's nearest local office. CITY agrees to put up signs along that portion of the Trail within or along DUKE ENERGY's Property stating "That the Trail is operated and maintained by the CITY." The sign shall provide CITY's current phone number to call for maintenance concerns or emergencies.
- D. DUKE ENERGY does not guarantee that CITY's Utilization will be completely compatible with the safe and efficient operation and maintenance of DUKE ENERGY's existing and future high voltage electric transmission and distribution lines within DUKE ENERGY's property. In the event that CITY's Utilization interferes with DUKE ENERGY's present or future use of the subject real Property, CITY agrees to relocate or adjust the Trail at CITY's sole cost and expense. CITY further agrees to reimburse DUKE ENERGY for all expenses associated with the relocation of any existing DUKE ENERGY facilities necessitated by CITY's Utilization.
- E. CITY acknowledges that its use of the Trail or DUKE ENERGY's Property shall be at CITY's sole risk and expense. DUKE ENERGY shall in no way be liable to CITY or any third party for any costs, expenses, losses, damages, or liabilities incurred by CITY or any third party in its use of DUKE ENERGY's Property. The CITY expressly retains all rights, benefits and immunities of sovereign immunity in accordance with Section 768.28, Florida Statutes. Each party shall be liable for its own actions and negligence. Notwithstanding anything set forth in any section of this Agreement to the contrary, nothing in this Agreement shall be deemed as a waiver of immunity or limits of liability of any party beyond any statutory limited waiver of immunity or limits of liability which may have been adopted by the Florida Legislature, or may be adopted by the Florida Legislature, and liability of any party for damages shall not exceed the statutory limits of liability, regardless of the number or nature of any claim which may arise, including, but not limited to, a claim sounding in tort, equity or contract.
- F. Post construction and acceptance of the Trail, the CITY shall be responsible for clean-up of any and all hazardous material spills resulting from the CITY's Utilization which may occur within DUKE ENERGY's Property. If a hazardous material spill occurs during Trail

maintenance, the CITY shall immediately report the nature and extent of the spill to DUKE ENERGY's nearest local office. The CITY agrees that no burning, refueling or stockpiling of dirt or other materials are allowed within DUKE ENERGY's Property.

G. Upon completion of construction of the Trail by the COUNTY and the CITY's acceptance of the same, the CITY shall acknowledge acceptance of the operation and maintenance responsibilities for the Trail. The CITY agrees to abide by all terms, conditions, and requirements of DUKE ENERGY as outlined in this AGREEMENT for the continued operation and maintenance of the Trail along DUKE ENERGY's property. In accordance with the State-Funded Grant Agreement FPN NO. 439039-3-54-01, the CITY shall have the right to impose and enforce reasonable rules and regulations for the public use of the Trail, and shall have the authority to close sections of the Trail from time to time as needed for maintenance and repair and to ensure public safety.

H. If, at any time while the terms of this Agreement are in effect, it shall come to the attention of the COUNTY, that the CITY's responsibility as established herein or a part thereof is not being properly accomplished pursuant to the terms of this Agreement, the County Manager, may, at his/her sole discretion, issue a written notice in care of the City Manager, 16 Colomba Rd., DeBary, FL, 32713, to place the CITY on notice thereof and specifying what corrective action is needed. Thereafter, the CITY shall have a period of no less than (30) thirty calendar days from receipt of the COUNTY's written notice within which to correct the cited deficiency or deficiencies. If said deficiency or deficiencies are not corrected within this time period the COUNTY may at its option, proceed as follows:

(1) Maintain the declared deficiency with COUNTY or a Contractor's material, equipment and personnel. The actual cost for such work will be the responsibility of the CITY and the COUNTY will send an invoice for actual cost to the CITY, or

(2) Close the trail to the public until such time as the CITY satisfactorily remedies the deficiency at the CITY's sole expense.

#### 4. MISCELLANEOUS.

A. COUNTY, CITY, and DUKE ENERGY agree that if construction of the Trail does not commence within eighteen (18) months of the execution date of this Trail Agreement, this Trail Agreement shall be null and void.

B. This Agreement shall not be assigned or transferred, in whole or in part, by COUNTY or CITY without the express written consent of DUKE ENERGY.

C. This Agreement shall be binding upon and inure to the benefit of the PARTIES hereto and their respective successors and assigns.

- D. This Agreement shall be executed in three (3) triplicate originals, any of which shall be regarded for all purposes as an original and all of which shall constitute one and the same instrument. Each Party shall retain one (1) fully executed original.
  
- E. This Agreement shall become effective upon the date last signed by the PARTIES.

IN WITNESS WHEREOF, the PARTIES have caused this TRAIL AGREEMENT to be executed as of the day and year first above written.

DUKE ENERGY FLORIDA, LLC  
Florida limited liability company d/b/a Duke  
Energy

Karen Adams  
By: Karen Adams- Manager, Land  
Services- Florida Region

WITNESSED BY:

Lori L. Herring  
Signature of First Witness

Lori L. Herring  
Print Name of First Witness

Trenton Newton  
Signature of Second Witness

Trenton Newton  
Print Name of Second Witness

State of FLORIDA )  
County of SEMNOL )

**APPROVED**  
By Karol P. Mack at 4:02 pm, Jan 13, 2020

The foregoing instrument was acknowledged before me by means of  physical presence or  online notarization, this 11<sup>th</sup> day of FEBRUARY, 2020, by Karen Adams of DUKE ENERGY FLORIDA LLC a Florida limited liability company d/b/a Duke Energy, on behalf of the company. She personally appeared before me at the time of notarization, and is personally known to me or has produced \_\_\_\_\_ as identification.

NOTARY SEAL

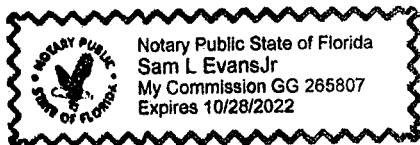

Sam L. Evans Jr.  
Print Name:  
Notary Public  
Serial Number:  
My Commission Expires:

SIGNED, SEALED, AND DELIVERED  
IN THE PRESENCE OF:

COUNTY OF VOLUSIA

By: [Signature]  
Print Name: George Recktenwald  
Title: County Manager

By: Ed Kelley  
Print Name: Ed Kelley  
Title: County Chair

By: [Signature]  
Print Name: MARJA V. KOLOMYSKI

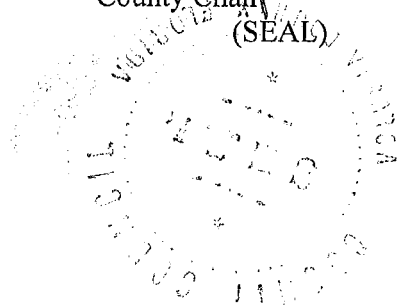

STATE OF FLORIDA }  
COUNTY OF VOLUSIA }

The foregoing instrument was acknowledged before me by means of  physical presence or  online notarization, this 19<sup>th</sup> day of May, 2020, by **Ed Kelley**, as **County Chair** of the County of Volusia, who is personally known to me and who ( ) did (  ) did not take an oath.

[Signature]  
Notary Public, State of Florida  
Printed: \_\_\_\_\_  
Commission No.: \_\_\_\_\_  
Expiration: \_\_\_\_\_

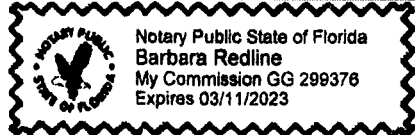

CITY OF DEBARY, FLORIDA

ATTEST:

  
\_\_\_\_\_  
Carmen Rosamonda  
City Manager

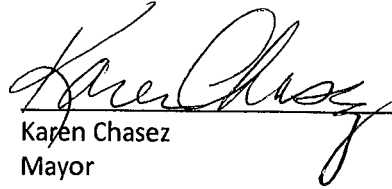
  
\_\_\_\_\_  
Karen Chasez  
Mayor

DATE: 4/22/2020

STATE OF FLORIDA    }  
COUNTY OF VOLUSIA }

The foregoing instrument was acknowledged before me by means of  physical presence or  
( ) online notarization, this 22nd day of April, 2020, by **Karen Chasez**, as  
**Mayor** of the City of DeBary, who is personally known to me and who ( ) did  did not take an oath.

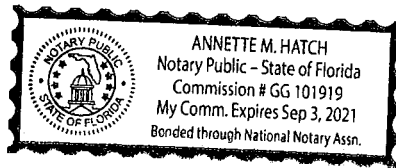

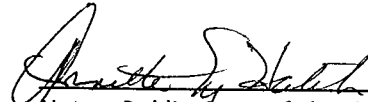
  
\_\_\_\_\_  
Notary Public, State of Florida  
Printed: Annette M Hatch  
Commission No.: GG 10919  
Expiration: 9/3/2021

# **APPENDIX F**

## **Specific Considerations for a JEA/COJ Interlocal Agreement for a Shared Use Path**



## **Specific Considerations for a JEA/City of Jacksonville Interlocal Agreement for a Shared Use Path**

The following are specific details from JEA's "Guidelines and Application for Use of JEA Real Property" that should be considered in any interlocal agreement for joint use of their property for shared use trails. Given that the City is the applicant, some of these may be able to be modified and/or waived. Additional coordination with JEA and the legal counsel of each party is advised prior to drafting the agreement.

1. Initiation of construction within 1 year of execution of agreement. (Note: This may be negotiable for the City.)
2. Insurance requirements:
  - a. JEA must be named as an insured
  - b. General liability and bodily injury at \$200,000 per person and \$500,000 and \$1,000,000 per occurrence; property damage at \$50,000 per occurrence and \$100,000 in aggregate; proof of insurance must be updated annually; and City is required to provide the annual proof of insurance.
3. Locations of stormwater retention ponds, if necessary, must be negotiated with JEA, though these types of drainage facilities are discouraged.
4. The following clearances are required:
  - a. Eighteen inches of vertical clearance between existing underground water and wastewater utilities.
  - b. Thirty-six inches of vertical clearance between existing underground electric, natural gas, and telecommunication utilities.
  - c. Ten-foot horizontal clearance required unless other applicable rules apply.
  - d. Forty-two inches of cover is maintained over existing electric, natural gas, and telecommunication utilities.
  - e. Thirty-six inches of cover is maintained over existing water and wastewater utilities.
  - f. Excavation is prohibited within twenty-five feet of any single wood pole structure and guying or within seventy-five feet of any steel or concrete structure, and within ten feet of any existing or proposed utility facility.
5. Landscaping is permitted provided it does not interfere with JEA access. Shrubbery must not exceed twelve feet in height (at maturity) and may not be planted within 15 feet of any existing facility. Trees are NOT permitted in electric, water or sewer right-of-way. "JEA Recommended Trees for Planting within Easement Areas" should be used to identify appropriate plant materials near transmission lines. The city is responsible for maintenance of landscaping and is required to remove any dead or unsuitable materials.
6. If the construction of the trail will not allow for the maintenance of a level twelve-foot-wide access road, then the trail will become that access road and must be constructed to JEA standards and the design should account for the types of vehicles used so maintenance can be limited.
7. Any trail signage or lighting must be preapproved by JEA.
8. Ingress/egress and parking facilities must be identified and approved by JEA. Legal descriptions and sketches for these areas must be prepared by a registered land surveyor.

9. If trail use is discontinued, the City agrees to restore property to as close to the original condition as possible.

# **APPENDIX G**

## **Example, Memorandum of Understanding City of Bellingham, WA**



## **SECTION 1 – SAMPLE MOU PRIVATE PROJECTS ON PARK PROPERTY**

---

### **PARKS AND RECREATION MEMORANDUM OF UNDERSTANDING**

**[PROJECT NAME]**

**[PROJECT NAME]**

**ATTN: [PROJECT CONTACT]**

**[CONTACT STREET ADDRESS]**

**[CITY, STATE ZIP]**

City of Bellingham

ATTN: Parks Department

3424 Meridian Street

Bellingham, Washington 98225

Re: Memorandum of Understanding (“MOU”) for **[PROJECT NAME]**

This MOU confirms that the City of Bellingham (the “City”) intends to participate and cooperate with **[PROJECT DESCRIPTION]** (the “Project”) at **[PROJECT LOCATION]**, in the location shown and per the plans, incorporated into Exhibit “A” attached to this MOU and incorporated herein by this reference.

Any changes, additions or modifications to this MOU should be memorialized in a properly executed writing.

The parties hereto acknowledge that the character of work undertaken in the Project is the type that should require the parties to be adequately insured and each party has assessed its own risks and will carry insurance as it deems appropriate and necessary.

The provisions of this MOU are not intended to create, nor shall they be in any way interpreted or construed to create a binding contract, a joint venture, employer/employee relationship, partnership, or any other similar relationship between the parties.

**[PROJECT PROPONENT NAME]** understands and acknowledges by its signature below that the failure to meet any Project milestone contained herein may, in the City's discretion, result in termination of the Project and **[PROJECT PROPONENT NAME]** acknowledges and accepts that risk.

The City's participation in the Project detailed in Exhibit "A" is expressly limited to the availability of funds for such participation and in the event that funding is withdrawn, reduced or limited in any way after the date of this MOU due to City budgetary constraints, and prior to its normal completion, the City may summarily terminate its participation in, and cooperation with the Project (thereby possibly terminating the Project as well) notwithstanding the existence of this MOU or any provisions hereof.

By signing below, the parties acknowledge that they have agreed to defend and indemnify the other from all claims or suits brought against the other by their own employees, contractors or subcontractors arising from the Project except to the extent that any such claim or suit is the result of the negligent act or omission of the party against whom the claim or suit is brought.

Please sign at the bottom of this page and return the original to the City address above. The City looks forward to working with you.

Sincerely,

\_\_\_\_\_  
Director of Parks and Recreation

Agreed and accepted by:

[PROJECT PROPONENT NAME]

By: \_\_\_\_\_

Title: \_\_\_\_\_

## EXHIBIT "A"—SCOPE OF THE PROJECT

Installation of a [PROJECT NAME]

**Statement of Purpose:**

[PROJECT PROPONENT NAME HERE] (PP), a volunteer citizens group located in Bellingham, WA, desires to install a permanent [PROJECT DESCRIPTION/NAME], "the project", in [PROJECT LOCATION], which is owned and operated by the City of Bellingham. The purpose of this MOU is to set forth the roles and responsibilities of the City and [PROJECT PROPONENT].

**Responsible Party Key**

[“PP”= PROJECT PROPONENT NAME; “PR”= City of Bellingham Parks and Recreation Dept.; “J”= Joint responsibility.]

**Task 1. Funding**

- 1.1. PP shall raise all funds and donations to support the project.
- 1.2. PP must partner with a non-profit umbrella group to hold funds for the project.
- 1.3. PP shall raise a minimum of [PROJECT DOLLAR AMOUNT], or all funds necessary to complete the project, in donations of money, materials or pro-bono services toward the installation prior to the start of construction. A detailed accounting of funds and commitments shall be submitted 15 days prior to the start of work.
- 1.4. In the event the project is not completed within [XX] calendar days from the start of construction, the City shall have access to any remaining funds held by the [NON-PROFIT NAME], to make the site safe by either completing the project, or removing materials and restoring the area to its original condition.

**Task 2. Planning and Design**

- 2.1. PP shall initiate final site planning in coordination with constituent group and Bellingham Parks Department.
- 2.2. PP shall develop final plans for PR review and approval by [INSERT DATE HERE].
- 2.3. PP shall select a Contractor, with COB approval by [INSERT DATE HERE]. The Contractor shall be licensed and bonded in the State of Washington and also hold a City of Bellingham Business License.
- 2.4. PL shall comply with state and local environmental regulations during construction, and obtain all necessary permits and approvals prior to starting work.

### **Task 3. Renovation Work and Completion**

- 3.1 Prior to the start of construction, the Contractor shall submit proof of insurance at the rates specified below and shall name the City as an additional insured:
  - [INSERT DOLLAR AMOUNT HERE] million Commercial General
  - [INSERT DOLLAR AMOUNT HERE] Worker's Compensation
  - [INSERT DOLLAR AMOUNT HERE] Automobile
- 3.2 Prior to starting construction, PP shall schedule a Pre-Construction meeting at the site with the contractor, Parks inspector, Parks Landscape Architect and others as deemed necessary, during regular City Business Hours.
- 3.3 Construction shall be limited to Monday-Friday 7 am- 7 pm, except as otherwise authorized in writing by the City.
- 3.4 PP [MAY or MAY NOT] use City provided water and electricity as available at the adjacent facility, but not during hours that the facility is rented by other parties. The City shall provide PL a list of facility reservations. All hoses and lines shall be secured so that the general public is protected from all safety hazards.
- 3.5 PP shall complete installation of the project and all associated work, including landscape restoration by end of business [INSERT DATE HERE]. Unless otherwise specified, all work shall be in compliance with City of Bellingham Parks and Public Works Standards.
- 3.6 PP shall assume all maintenance of the landscape restoration and of the project until such time as final acceptance by the City. The City's maintenance of the project is subject to available budget.

3.7 PP shall arrange for and coordinate all inspections required by regulating agencies.

**Task 4. Opening and Operation of the [PROJECT NAME HERE]**

4.1 PP shall reserve the site through the City's Facility reservation system for any special events to be held at the [PROJECT NAME HERE]. The Facility Reservation, will include, at a minimum, reservation of the [INSERT DESCRIPTION OF SITE FACILITIES HERE] for the duration of the special event.

4.2 Ongoing, volunteer maintenance of the [PROJECT NAME HERE] is encouraged, however, following the initial construction period, power equipment cannot be used by volunteers.



# **APPENDIX H**

## **Proposed Typical Sections for Recommended Alignment**

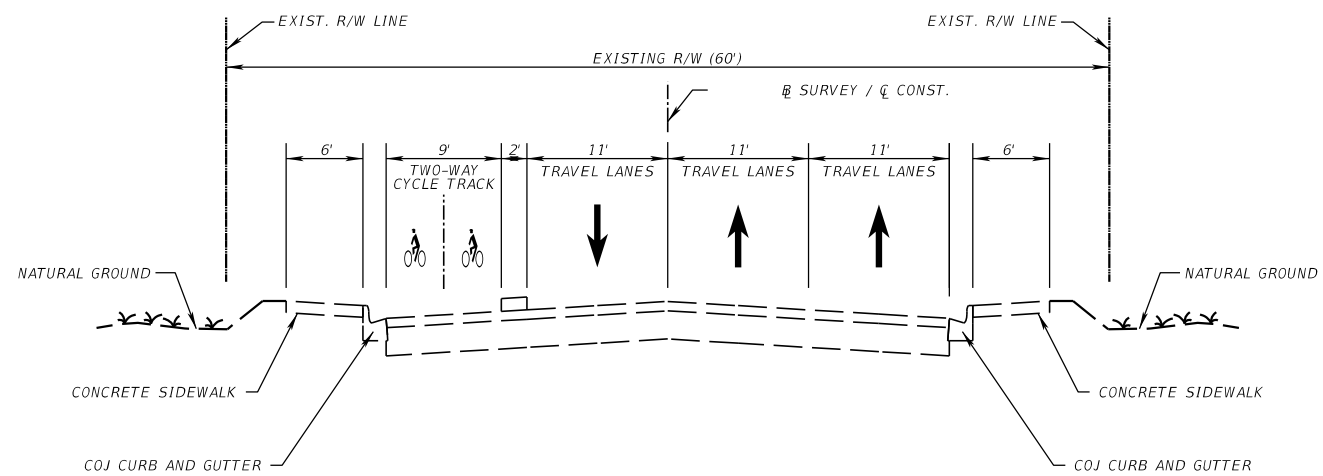

TYPICAL SECTION  
KINGS AVE  
(NIRA ST TO ATLANTIC BLVD)

7/17/2024 6:18:00 PM cmushi C:\Users\cmushi\Documents\Benesch\C2C Typical Sections\Microstation\Proposed\TYPSE003.dgn

REVISIONS				ENGINEER OF RECORD			PROPOSED TYPICAL SECTION	SEGMENT NO.
DATE	DESCRIPTION	DATE	DESCRIPTION	ROAD NO.	COUNTY	FINANCIAL PROJECT ID		1
				VARIES	DUVAL	N/A		

THE OFFICIAL RECORD OF THIS SHEET IS THE ELECTRONIC FILE DIGITALLY SIGNED AND SEALED UNDER RULE 61G15-23.004, F.A.C.

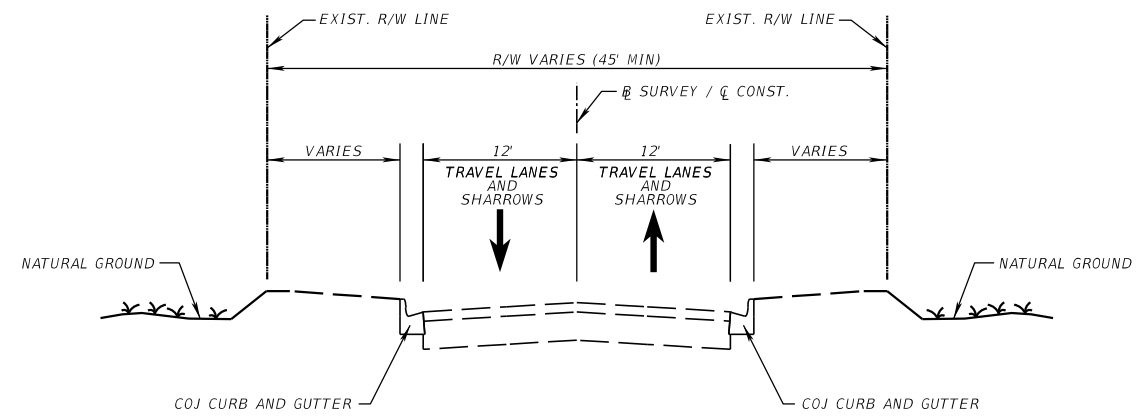

TYPICAL SECTION  
 STEVENS ST  
 (ATLANTIC BLVD. TO BERTHA ST)

7/17/2024 6:53:30 PM cmushi C:\Users\cmushi\Documents\Benesch\C2C Typical Sections\Microstation\Proposed\TYP\SRD03.dgn

REVISIONS				ENGINEER OF RECORD			PROPOSED TYPICAL SECTION	SEGMENT NO.
DATE	DESCRIPTION	DATE	DESCRIPTION	ROAD NO.	COUNTY	FINANCIAL PROJECT ID		3
				VARIES	DUVAL	N/A		

THE OFFICIAL RECORD OF THIS SHEET IS THE ELECTRONIC FILE DIGITALLY SIGNED AND SEALED UNDER RULE 61G15-23.004, F.A.C.

7/17/2024 5:59:54 PM cmushi  
 C:\Users\cmushi\Documents\Benesch\C2C Typical Sections\Microstation\Proposed\TYPSTR03.dgn

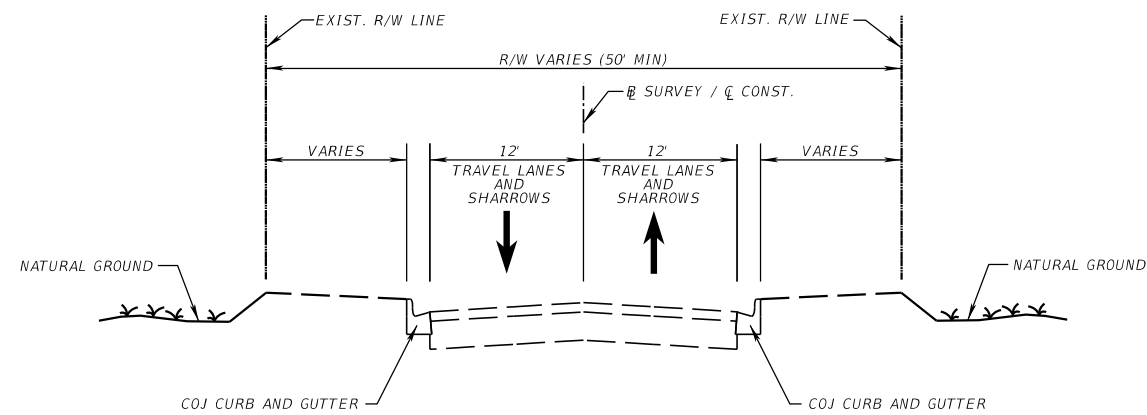

TYPICAL SECTION  
 BERTHA ST  
 (STEVENS ST. TO FLESHER AVE)

REVISIONS				ENGINEER OF RECORD			PROPOSED TYPICAL SECTION	SEGMENT NO.
DATE	DESCRIPTION	DATE	DESCRIPTION	ROAD NO.	COUNTY	FINANCIAL PROJECT ID		4
				VARIES	DUVAL	N/A		

THE OFFICIAL RECORD OF THIS SHEET IS THE ELECTRONIC FILE DIGITALLY SIGNED AND SEALED UNDER RULE 61G15-23.004, F.A.C.

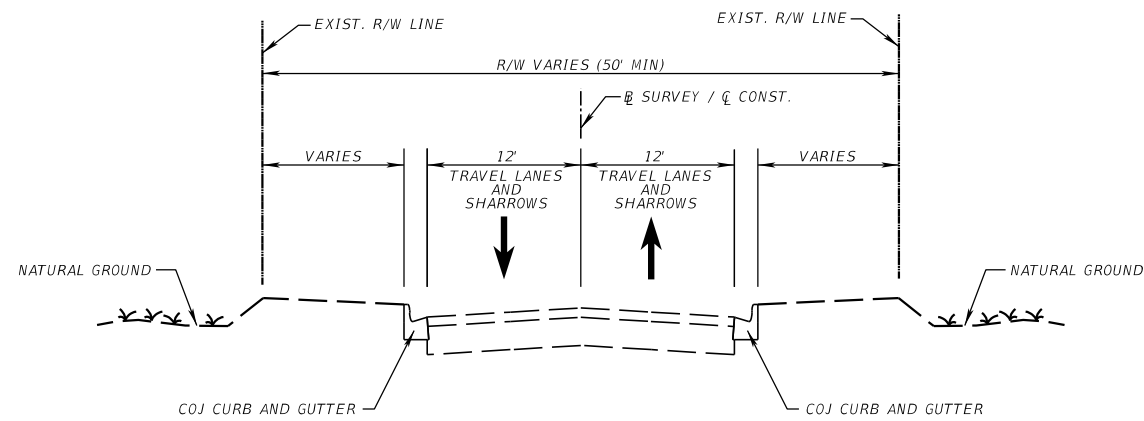

**TYPICAL SECTION  
FLESHER AVE  
(JERUSALEM BAPTIST CEMETERY TO GRAHAM AVE)**

7/17/2024 6:05:03 PM cmushi C:\Users\cmushi\Documents\Benesch\C2C Typical Sections\Microstation\Proposed\TYPSE003.dgn

REVISIONS				ENGINEER OF RECORD			<b>PROPOSED TYPICAL SECTION</b>	SEGMENT NO.
DATE	DESCRIPTION	DATE	DESCRIPTION	ROAD NO.	COUNTY	FINANCIAL PROJECT ID		5
				VARIES	DUVAL	N/A		

THE OFFICIAL RECORD OF THIS SHEET IS THE ELECTRONIC FILE DIGITALLY SIGNED AND SEALED UNDER RULE 61G15-23.004, F.A.C.

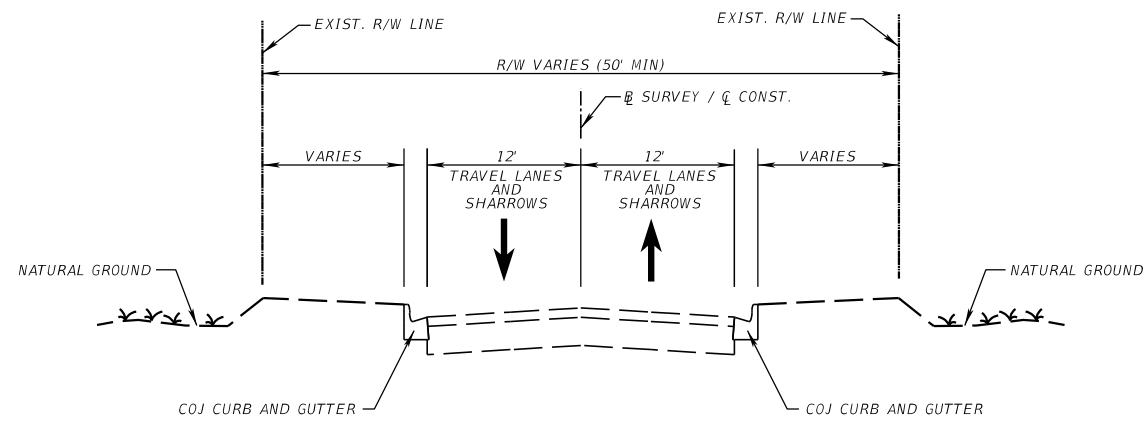

**TYPICAL SECTION  
GRAHAM AVE  
(JERUSALEM BAPTIST CEMETERY TO WHITE AVE)**

7/17/2024 6:13:22 PM cmushi C:\Users\cmushi\Documents\Benesch\C2C Typical Sections\Microstation\Proposed\TYP\SRD03.dgn

REVISIONS				ENGINEER OF RECORD			<b>PROPOSED TYPICAL SECTION</b>	SEGMENT NO.
DATE	DESCRIPTION	DATE	DESCRIPTION	ROAD NO.	COUNTY	FINANCIAL PROJECT ID		6
				VARIES	DUVAL	N/A		

THE OFFICIAL RECORD OF THIS SHEET IS THE ELECTRONIC FILE DIGITALLY SIGNED AND SEALED UNDER RULE 61G15-23.004, F.A.C.

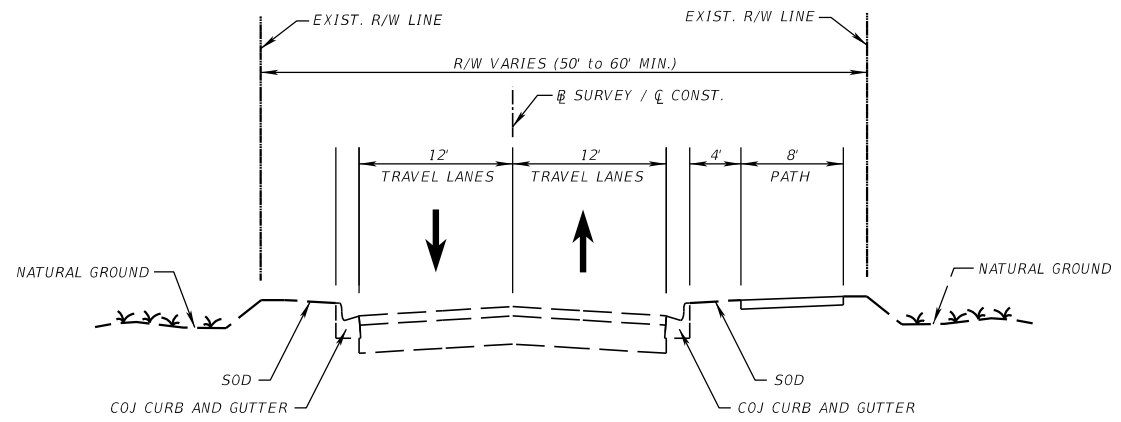

TYPICAL SECTION  
 WHITE AVE  
 (GRAHAM AVE TO SAN DIEGO RD.)

7/17/2024 6:39:47 PM cmushi C:\Users\cmushi\Documents\Benesch\C2C Typical Sections\Microstation\Proposed\TYPSE003.dgn

REVISIONS				ENGINEER OF RECORD			PROPOSED TYPICAL SECTION	SEGMENT NO.
DATE	DESCRIPTION	DATE	DESCRIPTION	ROAD NO.	COUNTY	FINANCIAL PROJECT ID		7
				VARIES	DUVAL	N/A		

THE OFFICIAL RECORD OF THIS SHEET IS THE ELECTRONIC FILE DIGITALLY SIGNED AND SEALED UNDER RULE 61G15-23.004, F.A.C.

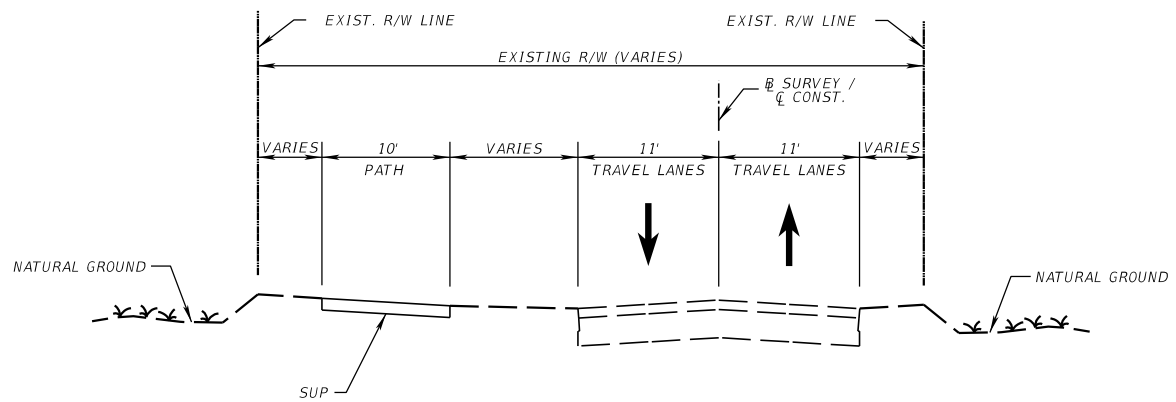

TYPICAL SECTION  
 SAN DIEGO RD  
 (WHITE AVE TO SPRING PARK RD.)

7/17/2024 6:24:53 PM cmushi C:\Users\cmushi\Documents\Benesch\C2C Typical Sections\Microstation\Proposed\TYPSRD03.dgn

REVISIONS				ENGINEER OF RECORD			PROPOSED TYPICAL SECTION	SEGMENT NO.
DATE	DESCRIPTION	DATE	DESCRIPTION	ROAD NO.	COUNTY	FINANCIAL PROJECT ID		8
				VARIES	DUVAL	N/A		

THE OFFICIAL RECORD OF THIS SHEET IS THE ELECTRONIC FILE DIGITALLY SIGNED AND SEALED UNDER RULE 61G15-23.004, F.A.C.



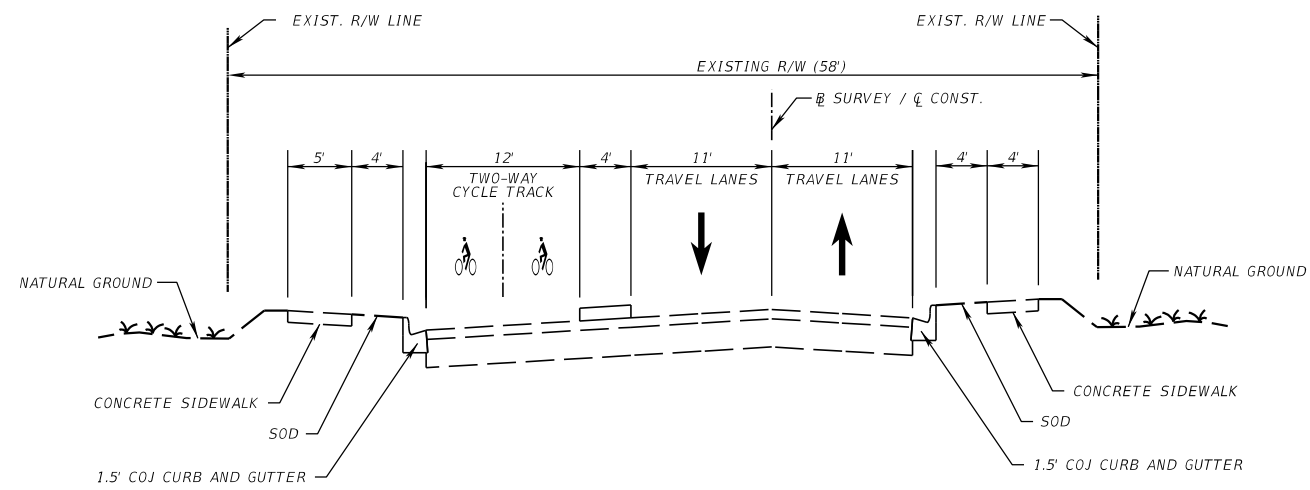

TYPICAL SECTION  
 SPRING PARK RD.  
 (SAN DIEGO RD. TO EMERSON ST.)

7/17/2024 6:23:46 PM cmushi C:\Users\cmushi\Documents\Benesch\C2C Typical Sections\Microstation\Proposed\TYPSRD03.dgn

REVISIONS				ENGINEER OF RECORD			PROPOSED TYPICAL SECTION	SEGMENT NO.
DATE	DESCRIPTION	DATE	DESCRIPTION	ROAD NO.	COUNTY	FINANCIAL PROJECT ID		9
				VARIES	DUVAL	N/A		

THE OFFICIAL RECORD OF THIS SHEET IS THE ELECTRONIC FILE DIGITALLY SIGNED AND SEALED UNDER RULE 61G15-23.004, F.A.C.

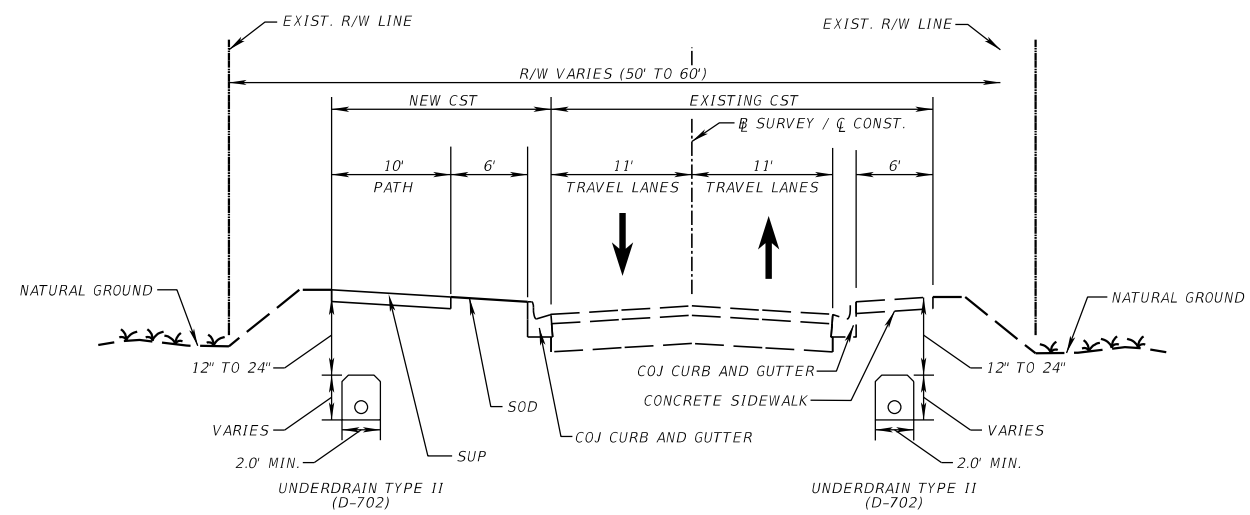

**TYPICAL SECTION**  
**SPRING PARK RD.**  
**(EMERSON ST TO SPRING GLEN RD.)**  
 STA. 50+00.00 TO STA. 60+00.00  
 STA. 71+30.00 TO STA. 74+50.00  
 STA. 85+76.82 TO STA. 88+00.00  
 STA. 97+50.00 TO STA. 117+60.00

7/17/2024 6:23:13 PM cmushi  
 C:\Users\cmushi\Documents\Benesch\C2C Typical Sections\Microstation\Proposed\TypSRD03.dgn

THE OFFICIAL RECORD OF THIS SHEET IS THE ELECTRONIC FILE DIGITALLY SIGNED AND SEALED UNDER RULE 61G15-23.004, F.A.C.

REVISIONS				ENGINEER OF RECORD			<b>PROPOSED TYPICAL SECTION</b>	SEGMENT NO.
DATE	DESCRIPTION	DATE	DESCRIPTION	ROAD NO.	COUNTY	FINANCIAL PROJECT ID		10
				VARIES	DUVAL	N/A		

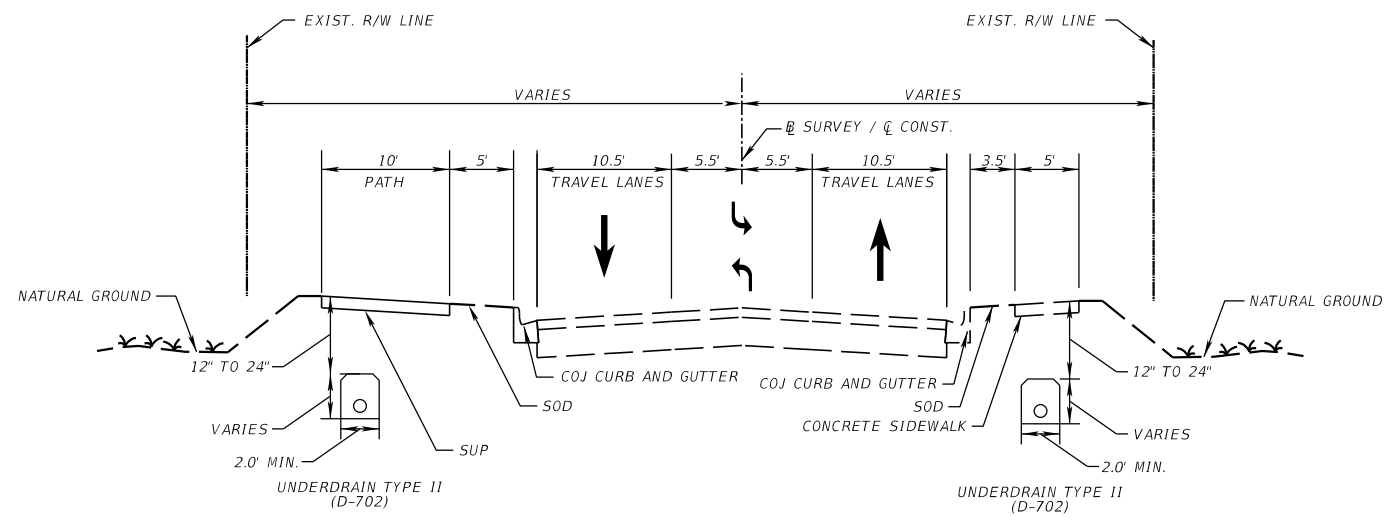

**TYPICAL SECTION**  
**SPRING PARK RD.**  
 (SPRING GLEN RD. TO EMERSON ST.)  
 STA. 60+00.00 TO STA. 71+30.00  
 STA. 74+50.00 TO STA. 80+27.37  
 STA. 88+00.00 TO STA. 97+50.00  
 STA. 117+60.00 TO STA. 123+54.05

7/17/2024 6:26:43 PM cmushi C:\Users\cmushi\Documents\Benesch\C2C Typical Sections\Microstation\Proposed\TYPSE003.dgn

REVISIONS				ENGINEER OF RECORD			<i>PROPOSED TYPICAL SECTION</i>	SEGMENT NO.
DATE	DESCRIPTION	DATE	DESCRIPTION	ROAD NO.	COUNTY	FINANCIAL PROJECT ID		10A
				VARIES	DUVAL	N/A		

THE OFFICIAL RECORD OF THIS SHEET IS THE ELECTRONIC FILE DIGITALLY SIGNED AND SEALED UNDER RULE 61G15-23.004, F.A.C.

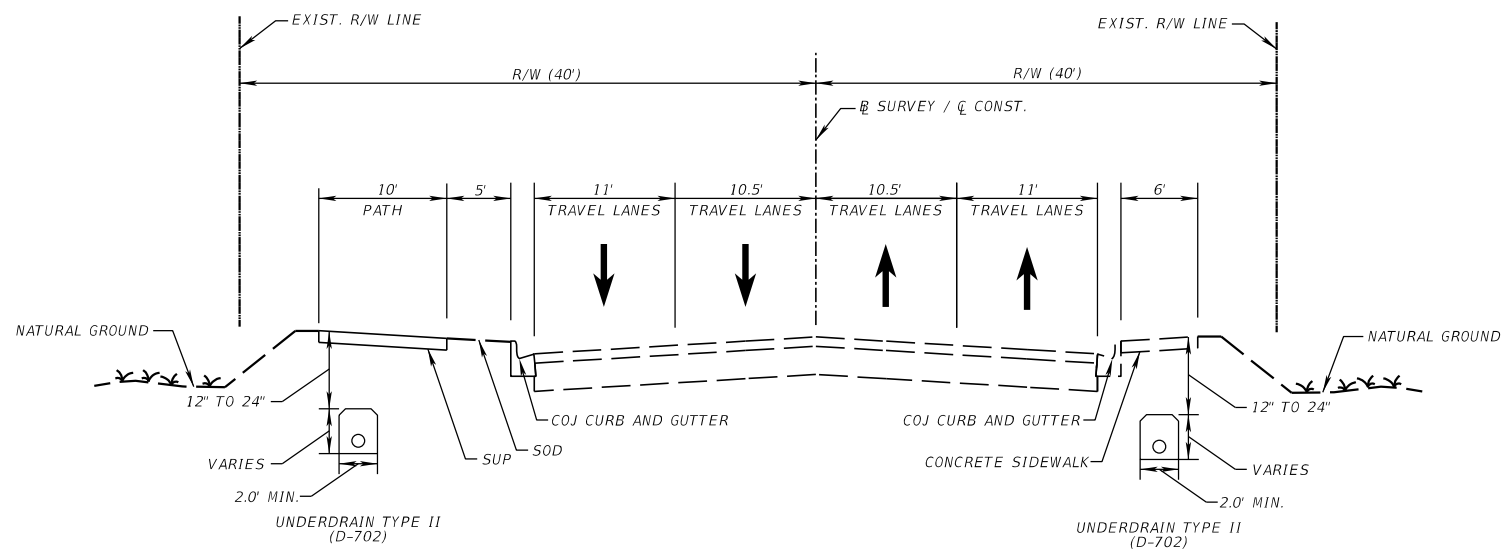

**TYPICAL SECTION**  
**SPRING GLEN RD.**  
 (SPRING PARK RD. TO SPRING PARK RD.)  
 STA. 80+93.12 TO STA. 82+26.49

7/17/2024 6:28:03 PM cmushi  
 C:\Users\cmushi\Documents\Benesch\C2C Typical Sections\Microstation\Proposed\TYPSPRD03.dgn

REVISIONS				ENGINEER OF RECORD			<b>PROPOSED TYPICAL SECTION</b>	SEGMENT NO.
DATE	DESCRIPTION	DATE	DESCRIPTION	ROAD NO.	COUNTY	FINANCIAL PROJECT ID		11
				VARIES	DUVAL	N/A		

THE OFFICIAL RECORD OF THIS SHEET IS THE ELECTRONIC FILE DIGITALLY SIGNED AND SEALED UNDER RULE 61G15-23.004, F.A.C.

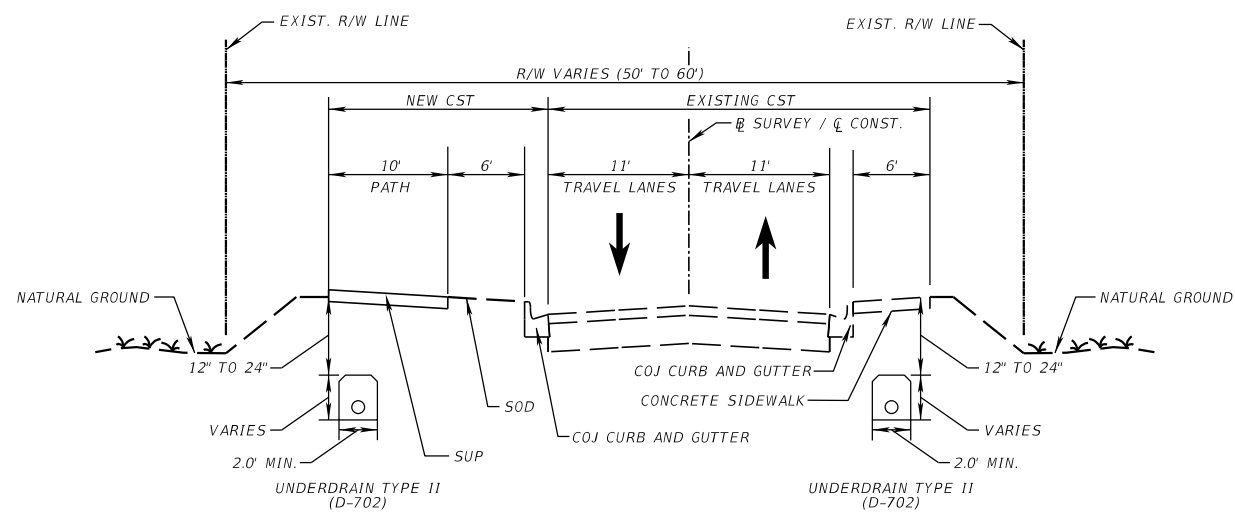

**TYPICAL SECTION**  
**SPRING PARK RD.**  
**(SPRING GLEN RD. TO UNIVERSITY BLVD.)**  
 STA. 50+00.00 TO STA. 60+00.00  
 STA. 71+30.00 TO STA. 74+50.00  
 STA. 85+76.82 TO STA. 88+00.00  
 STA. 97+50.00 TO STA. 117+60.00

7/17/2024 6:49:39 PM cmushi C:\Users\cmushi\Documents\Benesch\C2C Typical Sections\Microstation\Proposed\TYPSPRD03.dgn

THE OFFICIAL RECORD OF THIS SHEET IS THE ELECTRONIC FILE DIGITALLY SIGNED AND SEALED UNDER RULE 61G15-23.004, F.A.C.

REVISIONS				ENGINEER OF RECORD		STATE OF FLORIDA DEPARTMENT OF TRANSPORTATION			<b>PROPOSED TYPICAL SECTION</b>	SHEET NO.
DATE	DESCRIPTION	DATE	DESCRIPTION	LICENSE NUMBER:		ROAD NO.	COUNTY	FINANCIAL PROJECT ID		12
						VARIES	DUVAL	N/A		

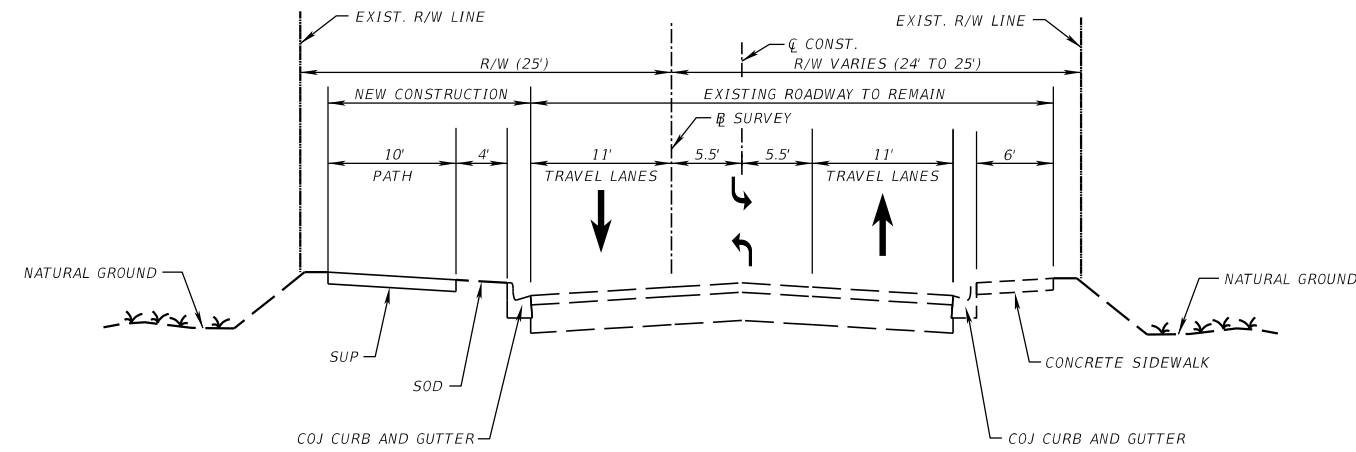

TYPICAL SECTION  
 SPRING PARK RD.  
 (UNIVERSITY BLVD. TO BOWDEN RD.)  
 STA. 30+43.00 TO STA. 50+50.00

7/17/2024 6:29:01 PM cmushi C:\Users\cmushi\Documents\Benesch\C2C Typical Sections\Microstation\Proposed\TYPSRD03.dgn

REVISIONS				ENGINEER OF RECORD			PROPOSED TYPICAL SECTION	SEGMENT NO.
DATE	DESCRIPTION	DATE	DESCRIPTION	ROAD NO.	COUNTY	FINANCIAL PROJECT ID		13
				VARIES	DUVAL	N/A		

THE OFFICIAL RECORD OF THIS SHEET IS THE ELECTRONIC FILE DIGITALLY SIGNED AND SEALED UNDER RULE 61G15-23.004, F.A.C.

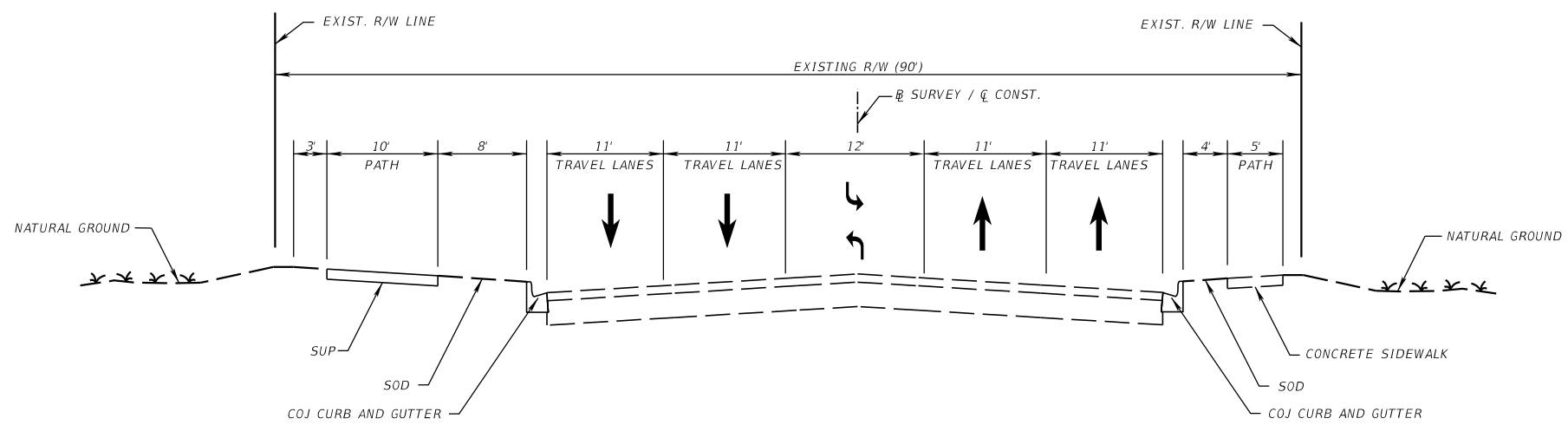

TYPICAL SECTION  
 BOWDEN RD.  
 (SPRING PARK RD. TO SOUTHPOINT PKWY)

7/19/2024 11:46:53 AM cmushi  
 C:\Users\cmushi\Documents\Benesch\C2C Typical Sections\Microstation\Proposed\TYPSE003.dgn

REVISIONS				ENGINEER OF RECORD			PROPOSED TYPICAL SECTION	SEGMENT NO.
DATE	DESCRIPTION	DATE	DESCRIPTION	ROAD NO.	COUNTY	FINANCIAL PROJECT ID		14
				VARIES	DUVAL	N/A		

THE OFFICIAL RECORD OF THIS SHEET IS THE ELECTRONIC FILE DIGITALLY SIGNED AND SEALED UNDER RULE 61G15-23.004, F.A.C.

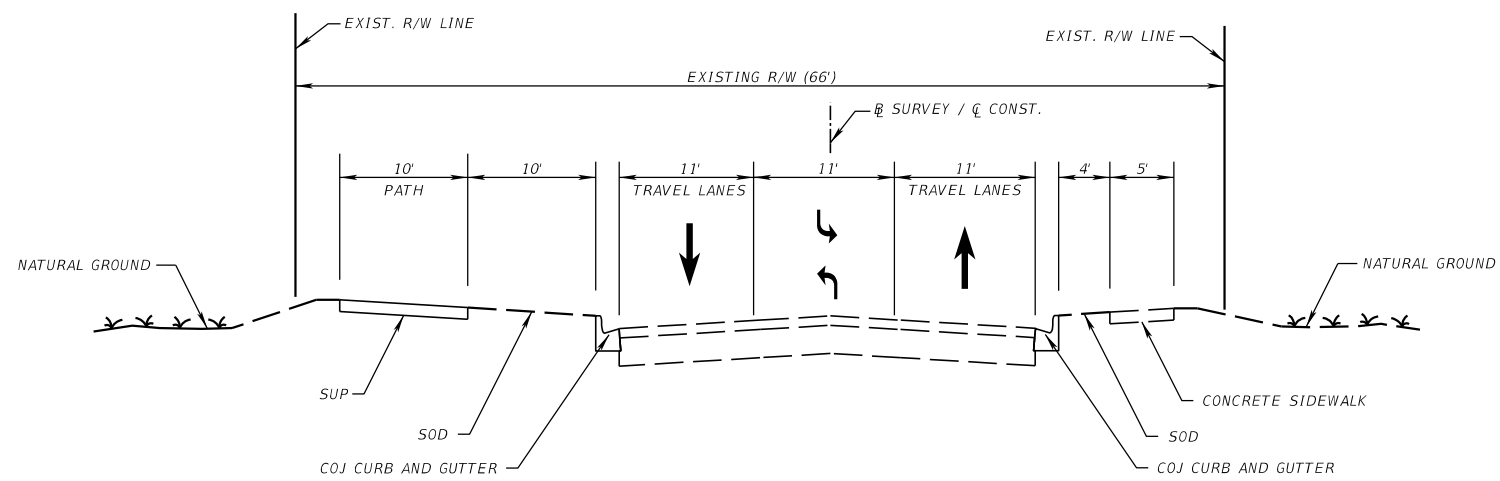

TYPICAL SECTION  
 BOWDEN RD.  
 (SOUTHPOINT PKWY TO PARENTAL HOME RD.)

7/19/2024 11:47:36 AM cmushi  
 C:\Users\cmushi\Documents\Benesch\C2C Typical Sections\Microstation\Proposed\TYPSE003.dgn

REVISIONS				ENGINEER OF RECORD			PROPOSED TYPICAL SECTION	SEGMENT NO.
DATE	DESCRIPTION	DATE	DESCRIPTION	ROAD NO.	COUNTY	FINANCIAL PROJECT ID		15
				VARIES	DUVAL	N/A		

THE OFFICIAL RECORD OF THIS SHEET IS THE ELECTRONIC FILE DIGITALLY SIGNED AND SEALED UNDER RULE 61G15-23.004, F.A.C.



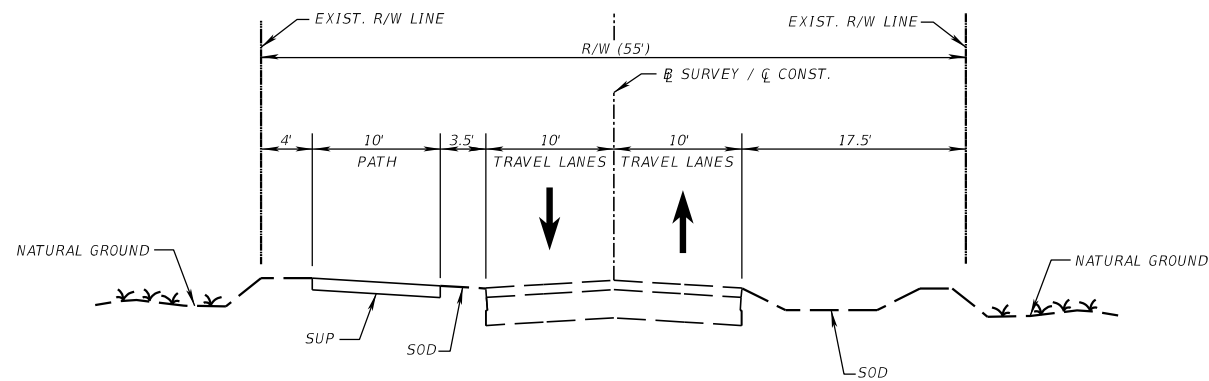

TYPICAL SECTION  
 BOWDEN RD.  
 (PARENTAL HOME RD. TO TIGER HOLE RD.)

7/20/2024 8:18:57 PM cmushi C:\Users\cmushi\Documents\Benesch\C2C Typical Sections\Microstation\Proposed\TYPSRD03.dgn

REVISIONS				ENGINEER OF RECORD			PROPOSED TYPICAL SECTION	SEGMENT NO.
DATE	DESCRIPTION	DATE	DESCRIPTION	ROAD NO.	COUNTY	FINANCIAL PROJECT ID		16
				VARIES				

THE OFFICIAL RECORD OF THIS SHEET IS THE ELECTRONIC FILE DIGITALLY SIGNED AND SEALED UNDER RULE 61G15-23.004, F.A.C.

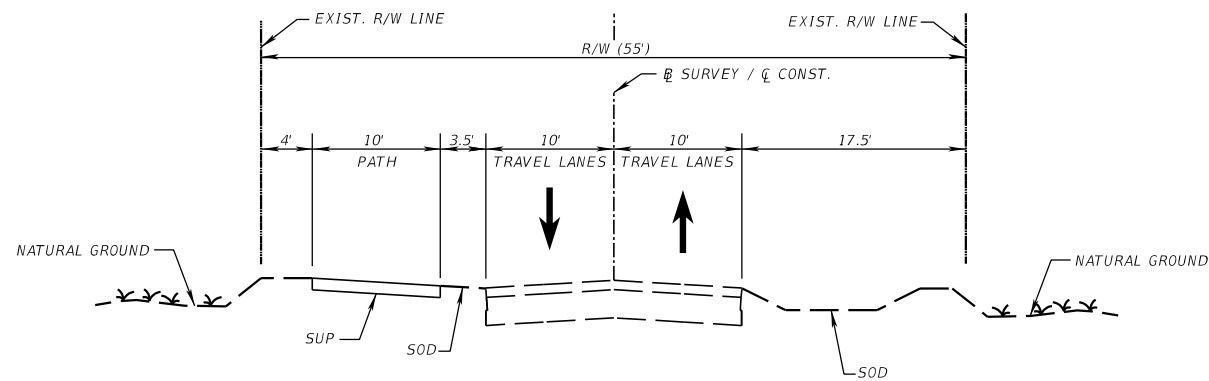

TYPICAL SECTION  
 BOWDEN RD.  
 (TIGER HOLE RD. TO BELFORT RD)

7/20/2024 8:19:22 PM cmushi  
 C:\Users\cmushi\Documents\Benesch\C2C Typical Sections\Microstation\Proposed\TYPSRD03.dgn

REVISIONS				ENGINEER OF RECORD			PROPOSED TYPICAL SECTION	SEGMENT NO.
DATE	DESCRIPTION	DATE	DESCRIPTION	ROAD NO.	COUNTY	FINANCIAL PROJECT ID		17
				VARIES	DUVAL	N/A		

THE OFFICIAL RECORD OF THIS SHEET IS THE ELECTRONIC FILE DIGITALLY SIGNED AND SEALED UNDER RULE 61G15-23.004, F.A.C.

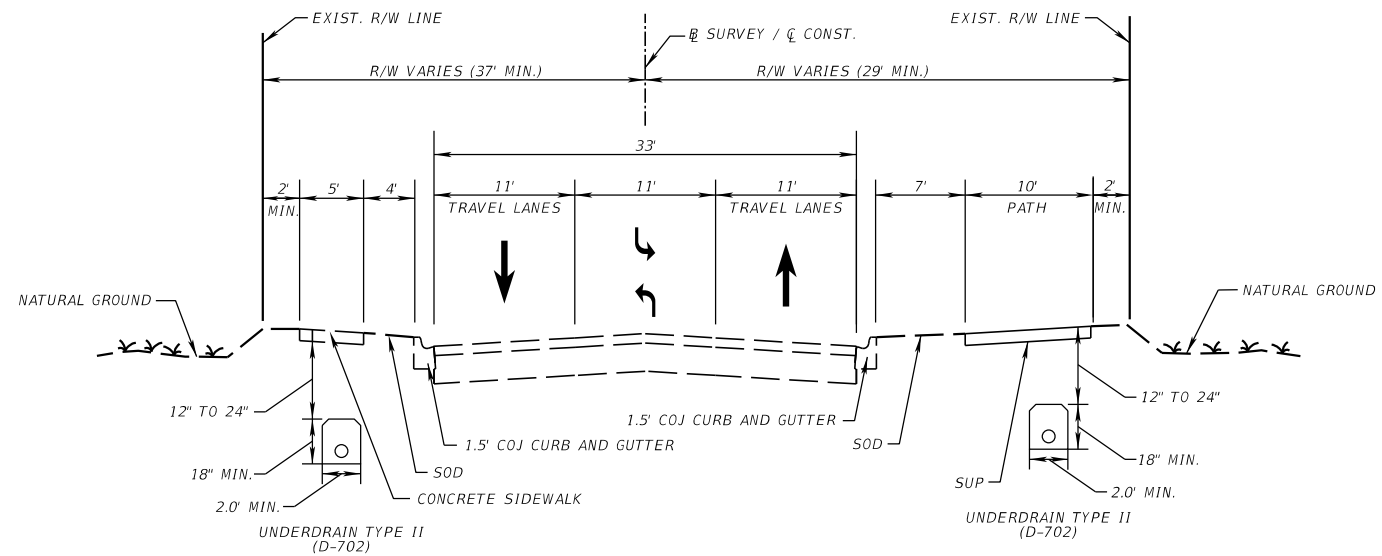

TYPICAL SECTION  
 BELFORT RD.  
 (BOWDEN RD S TO GATE PKWY W)

7/19/2024 12:01:45 PM cmushi C:\Users\cmushi\Documents\Benesch\C2C Typical Sections\Microstation\Proposed\TYPDR03.dgn

REVISIONS				ENGINEER OF RECORD			PROPOSED TYPICAL SECTION	SEGMENT NO.
DATE	DESCRIPTION	DATE	DESCRIPTION	ROAD NO.	COUNTY	FINANCIAL PROJECT ID		19
				VARIABLES	DUVAL	N/A		

THE OFFICIAL RECORD OF THIS SHEET IS THE ELECTRONIC FILE DIGITALLY SIGNED AND SEALED UNDER RULE 61G15-23.004, F.A.C.

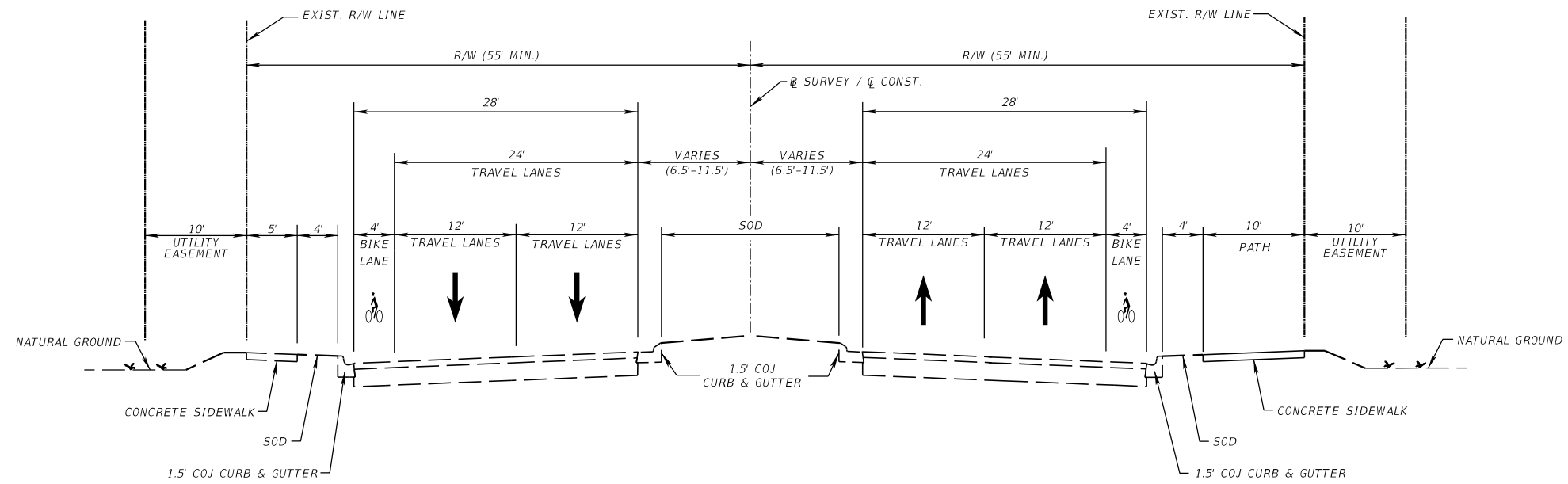

TYPICAL SECTION  
GATEWAY PARKWAY W  
(BELFORT RD. TO SOUTHSIDE BLVD.)

7/17/2024 6:08:41 PM cmushi C:\Users\cmushi\Documents\Benesch\C2C Typical Sections\Microstation\Proposed\TYPSPRD03.dgn

REVISIONS				ENGINEER OF RECORD			PROPOSED TYPICAL SECTION	SEGMENT NO:
DATE	DESCRIPTION	DATE	DESCRIPTION	ROAD NO.	COUNTY	FINANCIAL PROJECT ID		20
				VARIES	DUVAL	N/A		

THE OFFICIAL RECORD OF THIS SHEET IS THE ELECTRONIC FILE DIGITALLY SIGNED AND SEALED UNDER RULE 61G15-23.004, F.A.C.

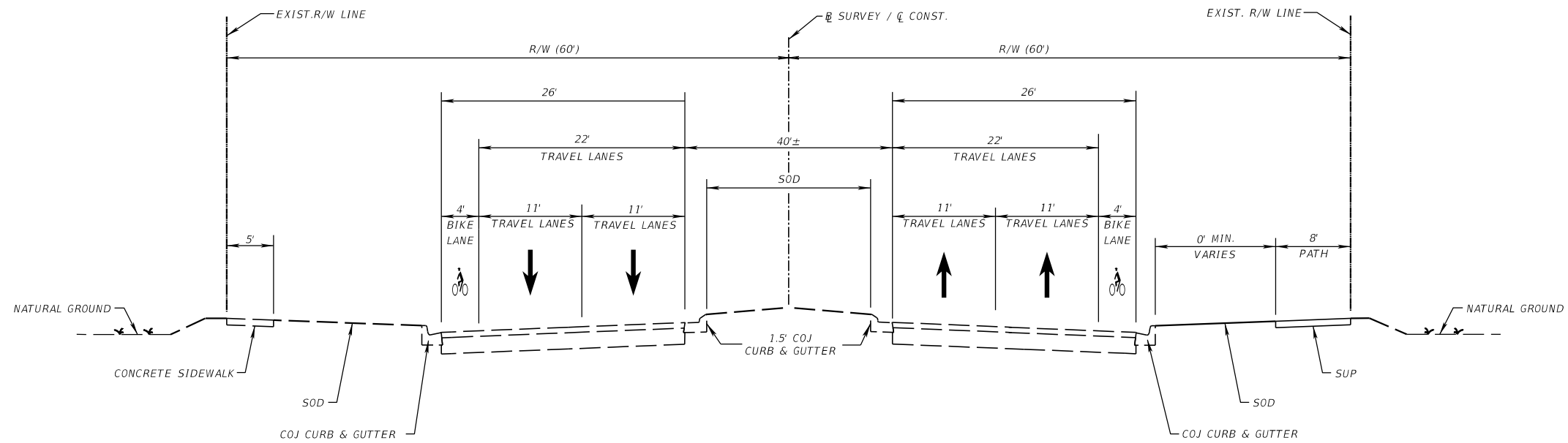

**TYPICAL SECTION**  
**GATE PARKWAY**  
 (SOUTHSIDE BLVD. TO TOWN CENTER PKWY.)  
 LEFT: STA. 14+29.86 TO STA. 75+54.33  
 RIGHT: STA. 12+22.99 TO STA. 73+00.00

7/17/2024 6:06:48 PM cmushi C:\Users\cmushi\Documents\Benesch\C2C Typical Sections\Microstation\Proposed\TYPSE003.dgn

THE OFFICIAL RECORD OF THIS SHEET IS THE ELECTRONIC FILE DIGITALLY SIGNED AND SEALED UNDER RULE 61G15-23.004, F.A.C.

REVISIONS				ENGINEER OF RECORD			<b>PROPOSED TYPICAL SECTION</b>	SEGMENT NO.
DATE	DESCRIPTION	DATE	DESCRIPTION	ROAD NO.	COUNTY	FINANCIAL PROJECT ID		21
				VARIES	DUVAL	N/A		

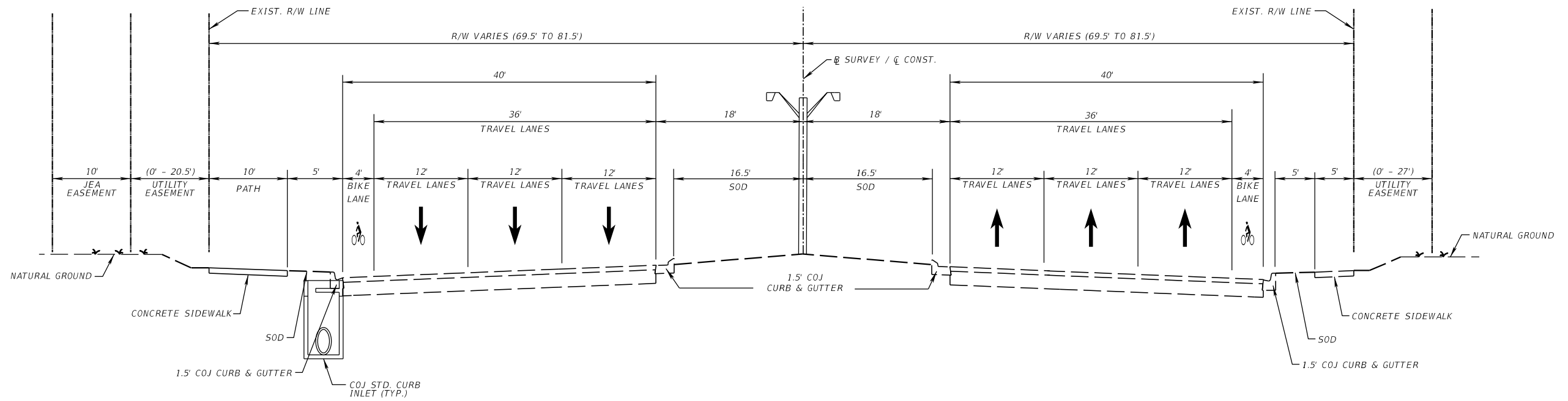

TYPICAL SECTION  
TOWN CENTER PARKWAY  
(BRIGHTMAN BLVD TO UNF DR. - PROPOSED)

7/17/2024 6:35:30 PM cmushi C:\Users\cmushi\Documents\Benesch\C2C Typical Sections\Microstation\Proposed\TYPSR003.dgn

REVISIONS				ENGINEER OF RECORD			PROPOSED TYPICAL SECTION	SEGMENT NO.
DATE	DESCRIPTION	DATE	DESCRIPTION	ROAD NO.	COUNTY	FINANCIAL PROJECT ID		23
				VARIES	DUVAL	N/A		

THE OFFICIAL RECORD OF THIS SHEET IS THE ELECTRONIC FILE DIGITALLY SIGNED AND SEALED UNDER RULE 61G15-23.004, F.A.C.

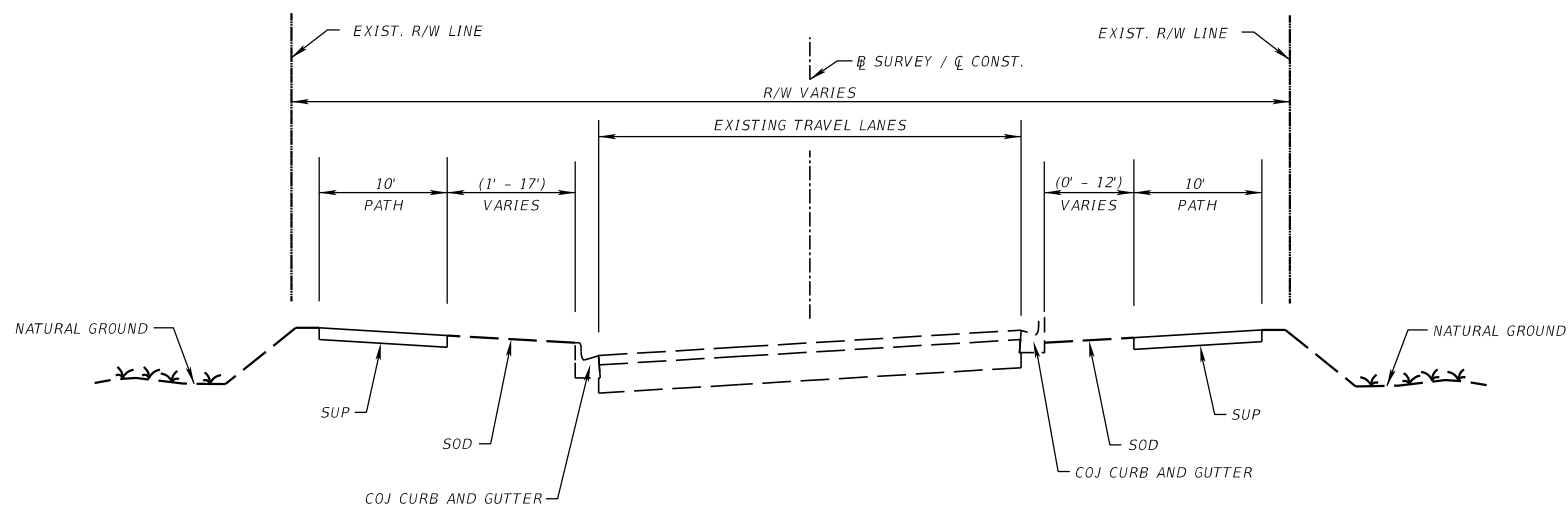

**TYPICAL SECTION**  
**UNF DR.**  
 (TOWN CENTER PKWY TO UNF DR)  
 STA. 108+15.23 TO STA. 121+19.76  
 STA. 121+34.31 TO STA. 132+95.74  
 STA. 108+44.81 TO STA. 109+90.73  
 STA. 110+43.58 TO STA. 111+92.43  
 STA. 112+07.31 TO STA. 125+42.68  
 STA. 125+66.19 TO STA. 129+54.54  
 STA. 130+17.33 TO STA. 131+65.43  
 STA. 132+65.43 TO STA. 133+07.78

7/17/2024 6:36:54 PM cmushi  
 C:\Users\cmushi\Documents\Benesch\C2C Typical Sections\Microstation\Proposed\TYPDR03.dgn

REVISIONS				ENGINEER OF RECORD			<b>PROPOSED TYPICAL SECTION</b>	SEGMENT NO.
DATE	DESCRIPTION	DATE	DESCRIPTION	ROAD NO.	COUNTY	FINANCIAL PROJECT ID		24
				VARIES	DUVAL	N/A		

THE OFFICIAL RECORD OF THIS SHEET IS THE ELECTRONIC FILE DIGITALLY SIGNED AND SEALED UNDER RULE 61G15-23.004, F.A.C.

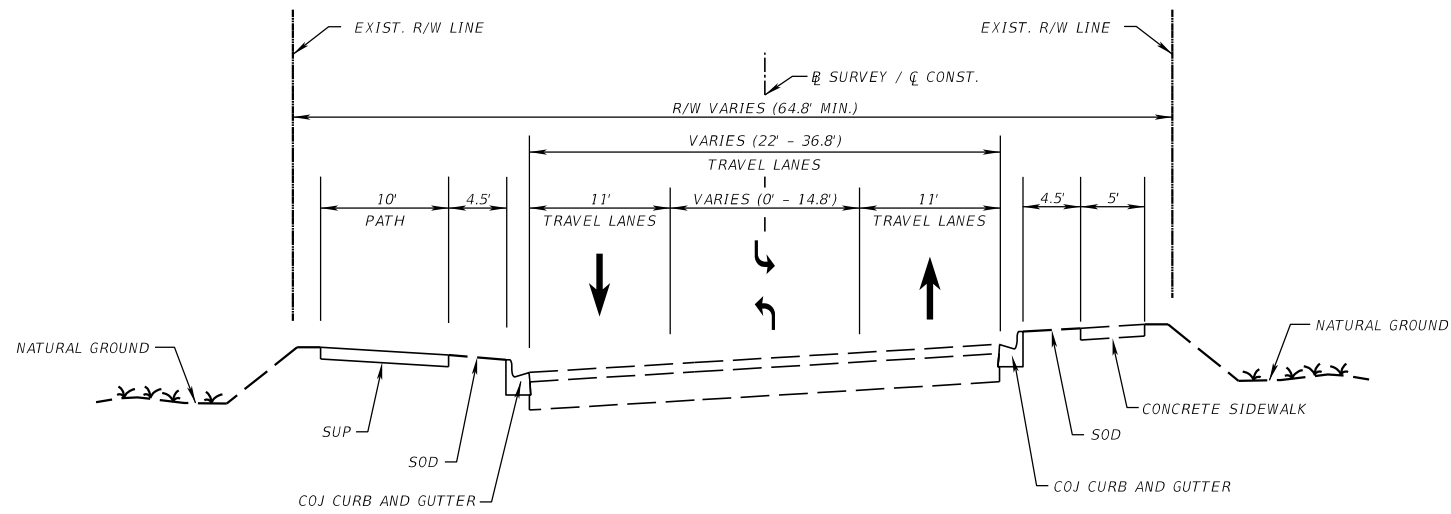

TYPICAL SECTION  
 UNF DR. SOUTH LOOP  
 (UND DR. TO ALUMNI DR.)

7/17/2024 6:40:39 PM cmushi C:\Users\cmushi\Documents\Benesch\C2C Typical Sections\Microstation\Proposed\TYPSE003.dgn

REVISIONS				ENGINEER OF RECORD			PROPOSED TYPICAL SECTION	SEGMENT NO.
DATE	DESCRIPTION	DATE	DESCRIPTION	ROAD NO.	COUNTY	FINANCIAL PROJECT ID		25
				VARIES	DUVAL	N/A		

THE OFFICIAL RECORD OF THIS SHEET IS THE ELECTRONIC FILE DIGITALLY SIGNED AND SEALED UNDER RULE 61G15-23.004, F.A.C.



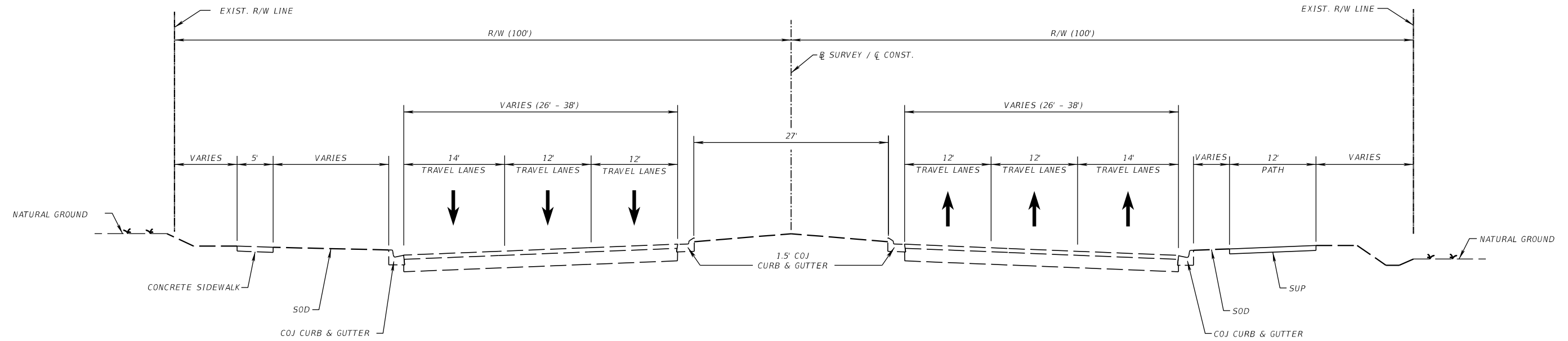

**TYPICAL SECTION**  
**KERNAN BLVD.**  
 (FIRST COAST TECH PKWY TO ASHLEY MELISSE BLVD.)

7/17/2024 6:20:18 PM cmushi C:\Users\cmushi\Documents\Benesch\C2C Typical Sections\Microstation\Proposed\TYPSRD03.dgn

THE OFFICIAL RECORD OF THIS SHEET IS THE ELECTRONIC FILE DIGITALLY SIGNED AND SEALED UNDER RULE 61G15-23.004, F.A.C

REVISIONS				ENGINEER OF RECORD			<i>PROPOSED TYPICAL SECTION</i>	SEGMENT NO.
DATE	DESCRIPTION	DATE	DESCRIPTION	ROAD NO.	COUNTY	FINANCIAL PROJECT ID		27
				VARIES	DUVAL	N/A		

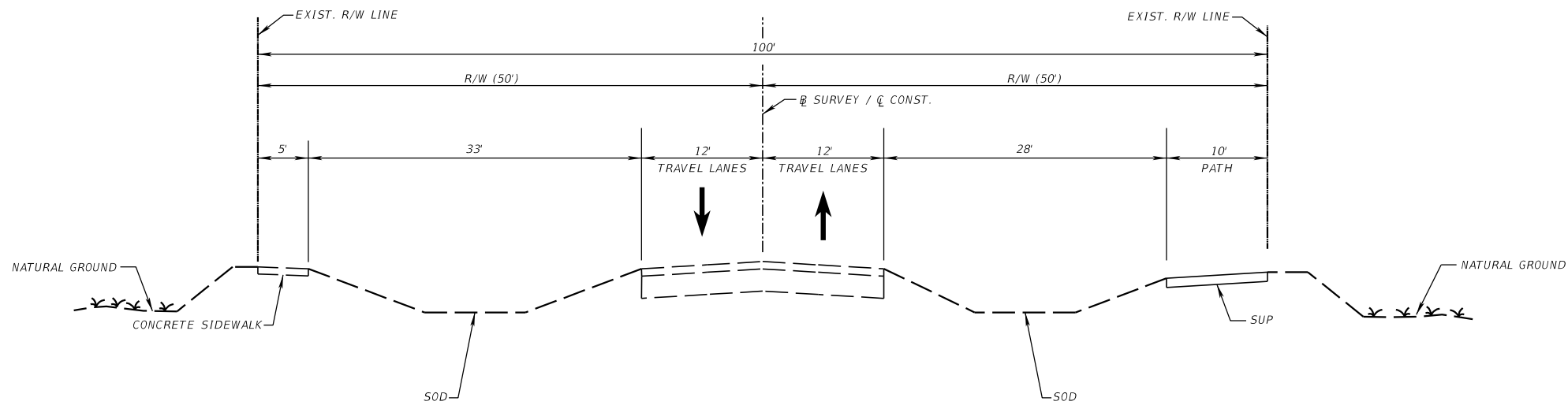

TYPICAL SECTION  
 ASHLEY MELISSE BLVD.  
 (KERNAN BLVD. TO GIRVIN RD.)

7/17/2024 5:56:39 PM cmushi C:\Users\cmushi\Documents\Benesch\C2C Typical Sections\Microstation\Proposed\Typical\Typical.dgn

REVISIONS				ENGINEER OF RECORD			PROPOSED TYPICAL SECTION	SEGMENT NO.
DATE	DESCRIPTION	DATE	DESCRIPTION	ROAD NO.	COUNTY	FINANCIAL PROJECT ID		29
				VARIES	DUVAL	N/A		

THE OFFICIAL RECORD OF THIS SHEET IS THE ELECTRONIC FILE DIGITALLY SIGNED AND SEALED UNDER RULE 61G15-23.004, F.A.C.

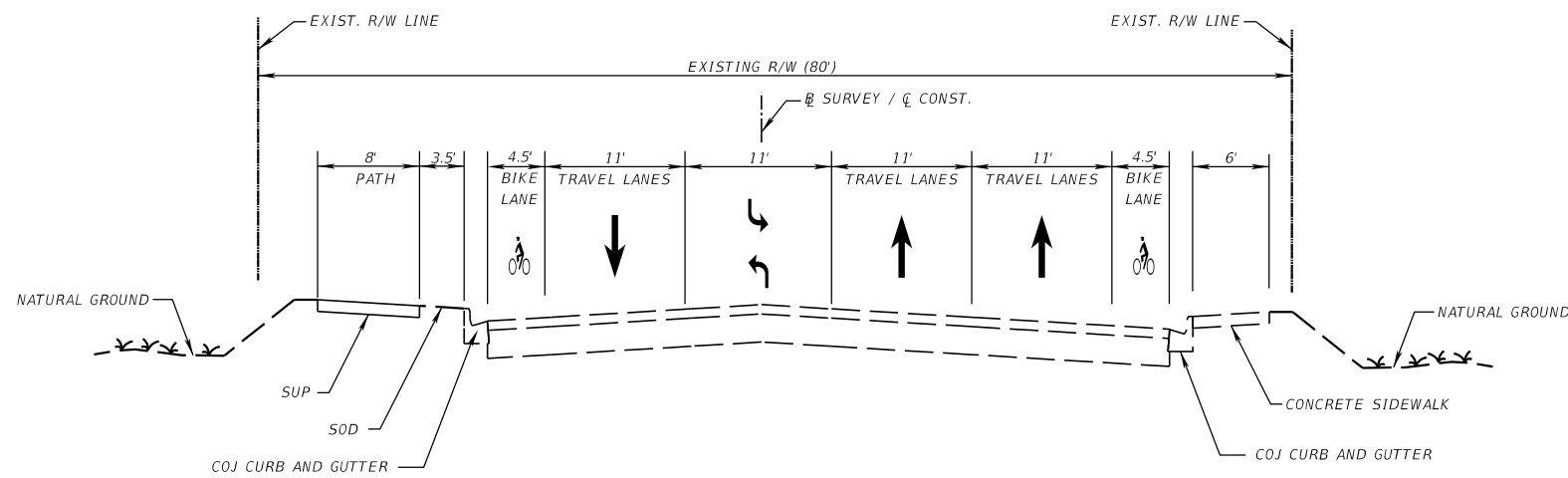

**TYPICAL SECTION**  
**GIRVIN RD.**  
**(ASHLEY MELISSE BLVD. TO WILDERLAND DR.)**  
**STA. 85+67.00 TO STA. 90+60.00**

7/17/2024 6:12:39 PM cmushi  
 C:\Users\cmushi\Documents\Benesch\C2C Typical Sections\Microstation\Proposed\TYPSR003.dgn

REVISIONS				ENGINEER OF RECORD			<b>PROPOSED TYPICAL SECTION</b>	SEGMENT NO:
DATE	DESCRIPTION	DATE	DESCRIPTION	ROAD NO.	COUNTY	FINANCIAL PROJECT ID		30A
				VARIES	DUVAL	N/A		

THE OFFICIAL RECORD OF THIS SHEET IS THE ELECTRONIC FILE DIGITALLY SIGNED AND SEALED UNDER RULE 61G15-23.004, F.A.C.

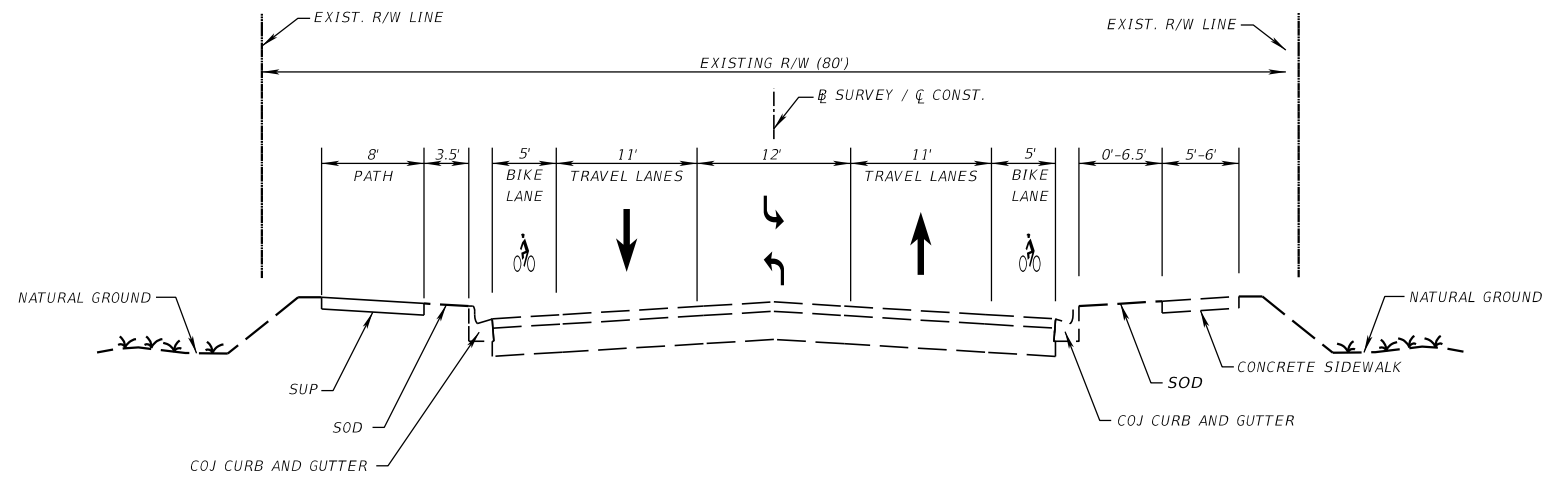

TYPICAL SECTION  
 GIRVIN RD.  
 (WILDERLAND DR. TO WONDERWOOD DR.)

7/17/2024 6:11:58 PM cmushi  
 C:\Users\cmushi\Documents\Benesch\C2C Typical Sections\Microstation\Proposed\TYPSE003.dgn

REVISIONS				ENGINEER OF RECORD			PROPOSED TYPICAL SECTION	SEGMENT NO.
DATE	DESCRIPTION	DATE	DESCRIPTION	ROAD NO.	COUNTY	FINANCIAL PROJECT ID		30B
				VARIES	DUVAL	N/A		

THE OFFICIAL RECORD OF THIS SHEET IS THE ELECTRONIC FILE DIGITALLY SIGNED AND SEALED UNDER RULE 61G15-23.004, F.A.C.

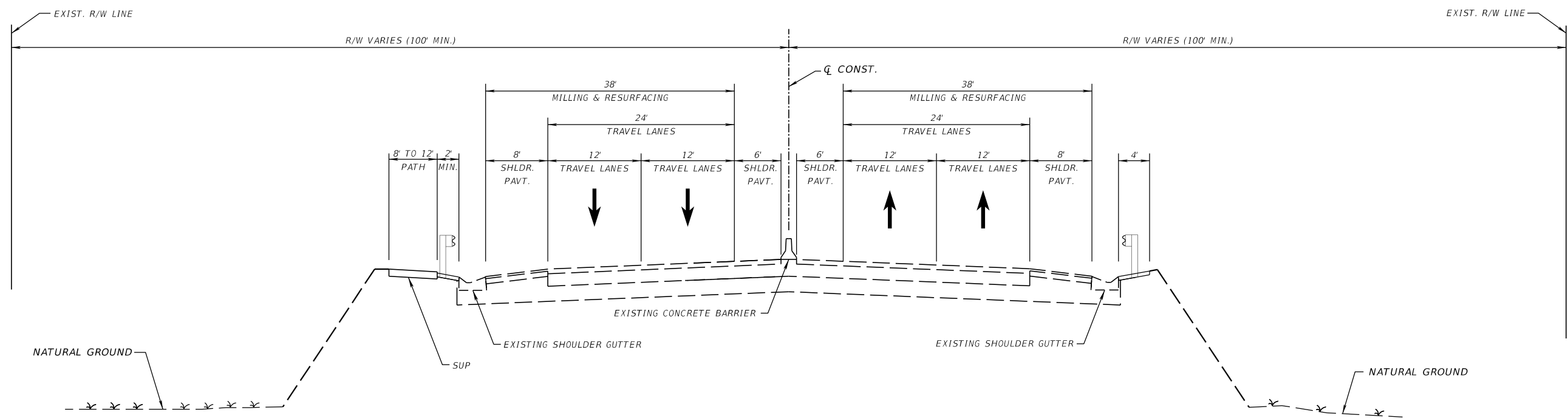

TYPICAL SECTION  
 SR 116 (WONDERWOOD DR.)  
 (GIRVIN RD. TO SAND CASTLE LN.)

7/17/2024 6:57:59 PM cmushi C:\Users\cmushi\Documents\Benesch\C2C Typical Sections\Microstation\Proposed\TYP\SRD03.dgn

REVISIONS				ENGINEER OF RECORD			PROPOSED TYPICAL SECTION	SEGMENT NO.
DATE	DESCRIPTION	DATE	DESCRIPTION	ROAD NO.	COUNTY	FINANCIAL PROJECT ID		31
				VARIES	DUVAL	N/A		

THE OFFICIAL RECORD OF THIS SHEET IS THE ELECTRONIC FILE DIGITALLY SIGNED AND SEALED UNDER RULE 61G15-23.004, F.A.C.

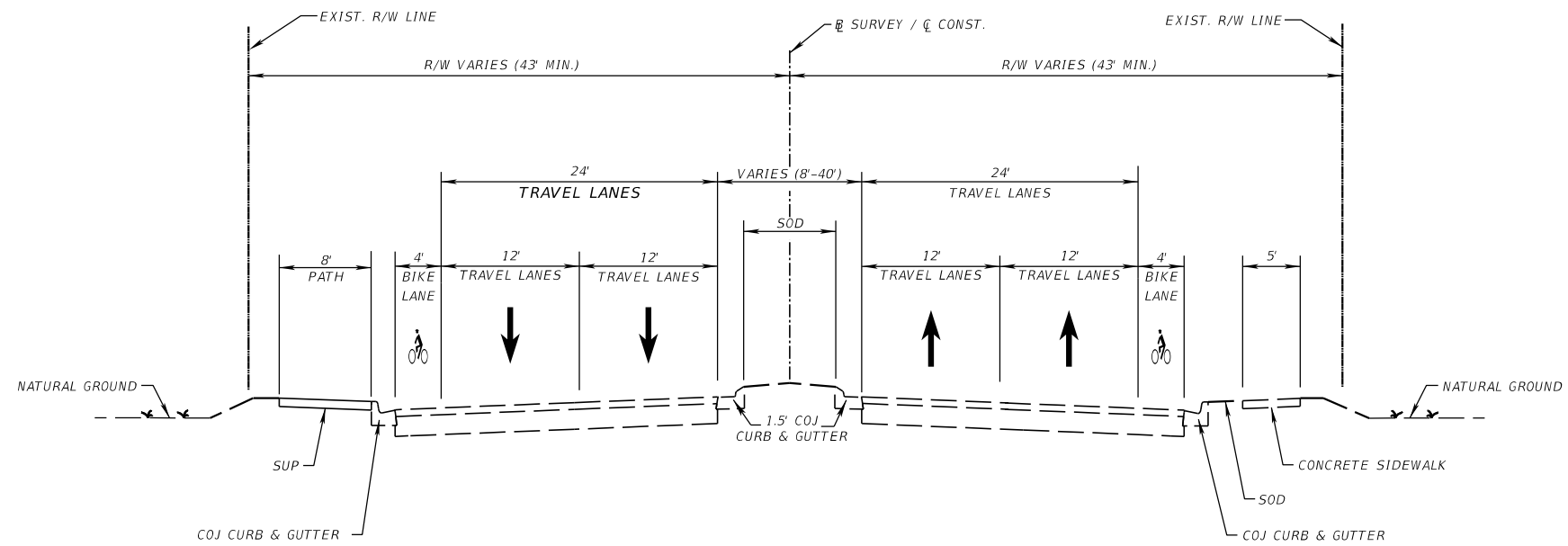

TYPICAL SECTION  
 SR 116 (WONDERWOOD DR.)  
 (SAND CASTLE LN. TO SR A1A)  
 STA. 282+70.00 TO STA. 285+57.717

7/17/2024 7:01:17 PM cmushi C:\Users\cmushi\Documents\Benesch\C2C Typical Sections\Microstation\Proposed\TYP\SRD03.dgn

THE OFFICIAL RECORD OF THIS SHEET IS THE ELECTRONIC FILE DIGITALLY SIGNED AND SEALED UNDER RULE 61G15-23.004, F.A.C.

REVISIONS				ENGINEER OF RECORD			PROPOSED TYPICAL SECTION	SEGMENT NO.
DATE	DESCRIPTION	DATE	DESCRIPTION	ROAD NO.	COUNTY	FINANCIAL PROJECT ID		35
				VARIES	DUVAL	N/A		

# **APPENDIX I**

## **Cost Estimate**

### **for Recommended Alignment**

Cost Estimate									
Core-2-Coast Trail Unfunded Segments									
Description	Percentage	Segment 1	Segment 2	Segment 3	Segment 4	Segment 5	Segment 6	Segment 7	Total
Length (Miles)		0.51	0.24	4.1	2.2	4.8	1.9	11.5	25.25
Demolition of Existing Sidewalk			\$43,569.60	\$782,885.78	\$202,382.46	\$1,023,628.52	\$103,978.18	\$1,116,697.74	\$3,273,142.29
SUP/Cycle Track		\$515,720.07	\$92,901.30	\$2,364,857.13	\$517,836.12	\$2,619,158.89	\$266,049.04	\$2,720,576.89	\$9,097,099.44
Signing and Pavement Marking		\$8,182.81		\$140,579.64					\$148,762.45
Other features				\$1,462,250.37	\$468,821.24	\$428,336.00			\$2,359,407.61
Lighting									\$0.00
<b>Subtotal</b>		<b>\$523,902.88</b>	<b>\$136,470.90</b>	<b>\$4,750,572.92</b>	<b>\$1,189,039.82</b>	<b>\$4,071,123.42</b>	<b>\$370,027.22</b>	<b>\$3,837,274.63</b>	<b>\$14,878,411.79</b>
Mobilization (10% Construction Total)	10%	\$52,390	\$13,647	\$475,057	\$118,904	\$407,112	\$37,003	\$383,727	\$1,487,841
MOT (10% Construction Total)	10%	\$52,390	\$13,647	\$475,057	\$118,904	\$407,112	\$37,003	\$383,727	\$1,487,841
Construction Subtotal		\$628,683	\$163,765	\$5,700,688	\$1,426,848	\$4,885,348	\$444,033	\$4,604,730	\$17,854,094
Contingency (10% Construction Subtotal)	10%	\$62,868	\$16,377	\$570,069	\$142,685	\$488,535	\$44,403	\$460,473	\$1,785,409
<b>Construction Total</b>		<b>\$691,552</b>	<b>\$180,142</b>	<b>\$6,270,756</b>	<b>\$1,569,533</b>	<b>\$5,373,883</b>	<b>\$488,436</b>	<b>\$5,065,203</b>	<b>\$19,639,504</b>
CEI (15% Construction Subtotal)	15%	\$94,303	\$24,565	\$855,103	\$214,027	\$732,802	\$66,605	\$690,709	\$2,678,114
PE (15% Construction Subtotal)	15%	\$94,303	\$24,565	\$855,103	\$214,027	\$732,802	\$66,605	\$690,709	\$2,678,114
Environmental Permitting		-	-	-	-	-	-	-	
<b>Subtotal</b>		<b>\$188,605</b>	<b>\$49,130</b>	<b>\$1,710,206</b>	<b>\$428,054</b>	<b>\$1,465,604</b>	<b>\$133,210</b>	<b>\$1,381,419</b>	<b>\$5,356,228</b>
<b>PROJECT TOTAL</b>		<b>\$880,157</b>	<b>\$229,271</b>	<b>\$7,980,963</b>	<b>\$1,997,587</b>	<b>\$6,839,487</b>	<b>\$621,646</b>	<b>\$6,446,621</b>	<b>\$24,995,732</b>



**COST ESTIMATES BY UNFUNDED SEGMENT**  
**FDOT LRE Cost per Mile Model: Two Directional, 12' Shared Use Path**

Sheet #	PIN	Improvement	Units	Length	Unit Cost	Total	Grand Total
Segment 1	1	<b>King Ave (Nira St. to Atlantic Blvd.)</b>					
	0327 70 6	Milling, 1.5" Avg. Depth	SY	13038.66667	\$5.71	\$74,450.79	\$523,902.88
	0337 7 83	Friction Course, Traffic C, FC-12.5, PG 76-22	TN	1075.69	\$167.79	\$180,490.03	
	0520 5 11	2' Conc. Separator	LF	2667	\$97.78	\$260,779.26	
	0711 14 160	Bike Symbols, Thermoplastic	EA	6	\$248.12	\$1,488.72	
	0711 14 170	Bike Arrow, Thermoplastic	EA	6	\$139.80	\$838.80	
0711 16 201	6" Yellow, Thermoplastic	GM	1.010227273	\$5,796.01	\$5,855.29		
Segment 2	2	<b>Atlantic Blvd (Kings Ave. to Stevens St.)</b>					
	0110 4 10	REMOVAL OF EXISTING CONCRETE	SY	580	\$75.12	\$43,569.60	\$136,470.90
	MIX	SUP	GM	0.164772727	\$563,814.79	\$92,901.30	
Segment 3	3	<b>Stevens St. (Atlantic Blvd. to Bertha St.)</b>					
	0327 70 6	Milling, 1.5" Avg. Depth	SY	1136.666667	\$5.71	\$6,490.37	\$23,179.54
	0337 7 83	Friction Course, Traffic C, FC-12.5, PG 76-22	TN	93.775	\$167.79	\$15,734.51	
	0711 16 201	6" Yellow, Thermoplastic	GM	0.088068182	\$5,796.01	\$510.44	
	0711 11 160	Sharrow	EA	2	\$222.11	\$444.22	
Segment 3	4	<b>Bertha St. (Stevens St. to Flesher Ave.)</b>					
	0327 70 6	Milling, 1.5" Avg. Depth	SY	1821.111111	\$5.71	\$10,398.54	\$36,869.62
	0337 7 83	Friction Course, Traffic C, FC-12.5, PG 76-22	TN	150.2416667	\$167.79	\$25,209.05	
	0711 16 201	6" Yellow, Thermoplastic	GM	0.141098485	\$5,796.01	\$817.81	
	0711 11 160	Sharrow	EA	2	\$222.11	\$444.22	
Segment 3	5	<b>Flesher Ave (Bertha St to Jerusalem Baptist Cemetary)</b>					
	0327 70 6	Milling, 1.5" Avg. Depth	SY	1711.111111	\$5.71	\$9,770.44	\$34,669.43
	0337 7 83	Friction Course, Traffic C, FC-12.5, PG 76-22	TN	141.1666667	\$167.79	\$23,686.36	
	0711 16 201	6" Yellow, Thermoplastic	GM	0.132575758	\$5,796.01	\$768.41	
	0711 11 160	Sharrow	EA	2	\$222.11	\$444.22	
Segment 3	6	<b>Graham Ave. (Jerusalem Baptist Cemetary to White Ave.)</b>					
	0327 70 6	Milling, 1.5" Avg. Depth	SY	1747.777778	\$5.71	\$9,979.81	\$35,402.83
	0337 7 83	Friction Course, Traffic C, FC-12.5, PG 76-22	TN	144.1916667	\$167.79	\$24,193.92	
	0711 16 201	6" Yellow, Thermoplastic	GM	0.135416667	\$5,796.01	\$784.88	
	0711 11 160	Sharrow	EA	2	\$222.11	\$444.22	
Segment 3	7	<b>White Ave. (Graham Ave. to San Diego Rd.)</b>					
	MIX	SUP	GM	0.272945076	\$563,814.79	\$153,890.47	\$214,034.46
	0110 4 10	REMOVAL OF EXISTING CONCRETE	SY	800.6388889	\$75.12	\$60,143.99	
Segment 3	8	<b>San Diego Rd. (White Ave. to Spring Park Rd.)</b>					
	MIX	SUP	GM	0.466857955	\$563,814.79	\$263,221.42	\$366,094.50
	0110 4 10	REMOVAL OF EXISTING CONCRETE	SY	1369.45	\$75.12	\$102,873.08	
Segment 3	9	<b>Spring Park Rd. (San Diego Rd. to Emerson St.)</b>					
	0327 70 6	Milling, 1.5" Avg. Depth	SY	14682.31333	\$5.71	\$83,836.01	\$637,555.95
	0337 7 83	Friction Course, Traffic C, FC-12.5, PG 76-22	TN	1211.291	\$167.79	\$203,242.52	
	0520 5 11	4' Conc. Separator	LF	3477.39	\$97.78	\$340,019.19	
	0711 14 160	Bike Symbols, Thermoplastic	EA	8	\$248.12	\$1,984.96	
	0711 14 170	Bike Arrow, Thermoplastic	EA	6	\$139.80	\$838.80	
	0711 16 201	6" Yellow, Thermoplastic	GM	1.317193182	\$5,796.01	\$7,634.46	
Segment 3	10	<b>Spring Park Rd. (Emerson St. to Spring Glen Rd.)</b>					
	MIX	SUP	GM	0.189393939	\$563,814.79	\$106,783.10	\$2,027,670.32
	MIX	SUP	GM	0.060606061	\$563,814.79	\$34,170.59	

**COST ESTIMATES BY UNFUNDED SEGMENT**  
**FDOT LRE Cost per Mile Model: Two Directional, 12' Shared Use Path**

	MIX	SUP	GM	0.658596591	\$563,814.79	\$371,326.50	
	MIX	SUP	GM	0.380681818	\$563,814.79	\$214,634.04	
	0110 4 10	REMOVAL OF EXISTING CONCRETE	SY	666.6666667	\$75.12	\$50,080.00	
	0110 4 10	REMOVAL OF EXISTING CONCRETE	SY	213.3333333	\$75.12	\$16,025.60	
	0110 4 10	REMOVAL OF EXISTING CONCRETE	SY	2318.26	\$75.12	\$174,147.69	
	0110 4 10	REMOVAL OF EXISTING CONCRETE	SY	1340	\$75.12	\$100,660.80	
	0440 1 20	UNDERDRAIN, TYPE II	LF	1000	\$141.00	\$141,000.00	
	0440 1 20	UNDERDRAIN, TYPE II	LF	320	\$141.00	\$45,120.00	
	0440 1 20	UNDERDRAIN, TYPE II	LF	3477.39	\$141.00	\$490,311.99	
	0440 1 20	UNDERDRAIN, TYPE II	LF	2010	\$141.00	\$283,410.00	
11	<b>Spring Glen Rd. (Spring Park Rd. to Spring Park Rd.)</b>						
	EXISTING SUP						
12	<b>Spring Park Rd. (Spring Glen Rd. to University Parkway)</b>						
	MIX	SUP	GM	0.189393939	\$563,814.79	\$106,783.10	\$1,060,272.02
	MIX	SUP	GM	0.060606061	\$563,814.79	\$34,170.59	
	MIX	SUP	GM	0.042268939	\$563,814.79	\$23,831.85	
	MIX	SUP	GM	0.380681818	\$563,814.79	\$214,634.04	
	0110 4 10	REMOVAL OF EXISTING CONCRETE	SY	666.6666667	\$75.12	\$50,080.00	
	0110 4 10	REMOVAL OF EXISTING CONCRETE	SY	213.3333333	\$75.12	\$16,025.60	
	0110 4 10	REMOVAL OF EXISTING CONCRETE	SY	155.4533333	\$75.12	\$11,677.65	
	0110 4 10	REMOVAL OF EXISTING CONCRETE	SY	1340	\$75.12	\$100,660.80	
	0440 1 20	UNDERDRAIN, TYPE II	LF	1000	\$141.00	\$141,000.00	
	0440 1 20	UNDERDRAIN, TYPE II	LF	320	\$141.00	\$45,120.00	
	0440 1 20	UNDERDRAIN, TYPE II	LF	233.18	\$141.00	\$32,878.38	
	0440 1 20	UNDERDRAIN, TYPE II	LF	2010	\$141.00	\$283,410.00	
13	<b>Spring Park Rd. (University Blvd. to Bowden Rd.)</b>						
	MIX	SUP	GM	0.380113636	\$563,814.79	\$214,313.69	\$314,824.25
	0110 4 10	REMOVAL OF EXISTING CONCRETE	SY	1338	\$75.12	\$100,510.56	
14	<b>Bowden Rd. (Spring Park Rd. to Southpoint Parkway)</b>						
	MIX	SUP	GM	0.242659091	\$563,814.79	\$136,814.78	\$190,285.20
	0110 4 10	REMOVAL OF EXISTING CONCRETE	SY	711.8	\$75.12	\$53,470.42	
15	<b>Bowden Rd. (Southpoint Parkway to Parental Home Rd.) (FUNDED)</b>						
16	<b>Bowden Rd. (Parental Home Rd. to Tiger Hole Rd.) (FUNDED)</b>						
17	<b>Bowden Rd. (Tiger Hole Rd. to Belfort Rd.)</b>						
	MIX	SUP	GM	0.462223485	\$563,814.79	\$260,608.44	\$362,460.31
	0110 4 10	REMOVAL OF EXISTING CONCRETE	SY	1355.855556	\$75.12	\$101,851.87	
19	<b>Belfort Rd. (Bowden Rd. S. to Gate Parkway W.)</b>						
	MIX	SUP	GM	0.213568182	\$563,814.79	\$120,412.90	\$636,294.32
	0110 4 10	REMOVAL OF EXISTING CONCRETE	SY	626.4666667	\$75.12	\$47,060.18	
	0440 1 20	UNDERDRAIN, TYPE II	LF	1127.64	\$141.00	\$158,997.24	
		BRIDGE	LF	193.64	\$1,600.00	\$309,824.00	

Segment 3 (Cont'd)

Segment 4

**COST ESTIMATES BY UNFUNDED SEGMENT**  
**FDOT LRE Cost per Mile Model: Two Directional, 12' Shared Use Path**

Segment 5	20	<b>Gateway Parkway W. (Belfort Rd. to Southside Blvd.)</b>					
	MIX	SUP	GM	1.81	\$563,814.79	\$1,020,504.77	\$1,419,341.89
	0110 4 10	REMOVAL OF EXISTING CONCRETE	SY	5309.333333	\$75.12	\$398,837.12	
	21	<b>Gate Parkway (Southside Blvd. to Town Center Parkway)</b>					
	MIX	SUP - LEFT	GM	1.1599375	\$563,814.79	\$653,989.92	\$1,812,120.34
	MIX	SUP - RIGHT	GM	1.150948864	\$563,814.79	\$648,921.99	
	0110 4 10	REMOVAL OF EXISTING CONCRETE - LEFT	SY	3402.483333	\$75.12	\$255,594.55	
	0110 4 10	REMOVAL OF EXISTING CONCRETE - RIGHT	SY	3376.116667	\$75.12	\$253,613.88	
	23	<b>Town Center Parkway (Brightman Blvd. to UNF Dr.)</b>					
	MIX	SUP	GM	0.524537879	\$563,814.79	\$295,742.21	\$839,661.18
0110 4 10	REMOVAL OF EXISTING CONCRETE	SY	1538.644444	\$75.12	\$115,582.97		
		BRIDGE	LF	267.71	\$1,600.00	\$428,336.00	
Segment 6	24	<b>UNF Dr. (Town Center Parkway to UNF Dr.) (FUNDED)</b>					
	25	<b>UNF Dr. South Loop (UNF Dr. to Alumni Dr.) (FUNDED)</b>					
	27	<b>Kernan Blvd. (Alumni Dr. to Glen Kernan Pkwy.)</b>					
	MIX	SUP	GM	0.471873106	\$563,814.79	\$266,049.04	\$370,027.22
	0110 4 10	REMOVAL OF EXISTING CONCRETE	SY	1384.161111	\$75.12	\$103,978.18	
Segment 7	29	<b>Ashley Melisse Blvd. (Kernan Blvd. to Girvin Rd.)</b>					
	MIX	SUP	GM	1.66	\$563,814.79	\$935,932.55	\$1,301,716.87
	0110 4 10	REMOVAL OF EXISTING CONCRETE	SY	4869.333333	\$75.12	\$365,784.32	
	30A	<b>Girvin Rd. (Ashley Melisse Blvd. to Wilderland Dr.)</b>					
	MIX	SUP	GM	0.093371212	\$563,814.79	\$52,644.07	\$73,218.60
	0110 4 10	REMOVAL OF EXISTING CONCRETE	SY	273.8888889	\$75.12	\$20,574.53	
	30B	<b>Girvin Rd. (Wilderland Dr. to Wonderwood Dr.)</b>					
	MIX	SUP	GM	1.58	\$563,814.79	\$890,827.37	\$1,238,983.53
	0110 4 10	REMOVAL OF EXISTING CONCRETE	SY	4634.666667	\$75.12	\$348,156.16	
	31	<b>SR 116/Wonderwood Dr. (Girvin Rd. to Sand Castle Ln.)</b>					
	Wonderwood Bridge						
31A	<b>SR 116/Wonderwood Dr. (Girvin Rd. to Start of Bridge)</b>						
MIX	SUP	GM	0.919793561	\$563,814.79	\$518,593.21	\$751,891.39	
0110 4 10	REMOVAL OF EXISTING CONCRETE	SY	3105.673333	\$75.12	\$233,298.18		
31B	<b>SR 116/Wonderwood Dr. (End of Bridge to Sand Castle Ln.)</b>						
MIX	SUP	GM	0.517645833	\$563,814.79	\$291,856.38	\$428,733.53	
0110 4 10	REMOVAL OF EXISTING CONCRETE	SY	1822.113333	\$75.12	\$136,877.15		
35	<b>SR 116/Wonderwood Dr. (Sand Castle Ln. to SR A1A)</b>						
MIX	SUP	GM	0.054491856	\$563,814.79	\$30,723.31	\$42,730.70	
0110 4 10	REMOVAL OF EXISTING CONCRETE	SY	159.8427778	\$75.12	\$12,007.39		

**TOTAL (UNFUNDED SEGMENTS)**

**\$14,878,411.79**

FDOT Long Range Estimating System - Production					
R4: Project Details Composite Report					
By Version					
<b>Project:</b> SHRUSE-O-01-BB				<b>Letting Date:</b> 01/2099	
<b>Description:</b> Two Directional, 12' Shared Use Path					
<b>District:</b> 09	<b>County:</b> 99 DISTRICT/STATE WIDE				
<b>Project Manager:</b> Cost-Per-Mile Model					
<b>Version 17 Project Grand Total</b>					<b>\$563,814.79</b>
<b>Description:</b> December 2023					
Pay Items					
Pay Item	Description	Total Quantity	Unit	Weighted Avg. Unit Price	Total Amount
102-1	MAINTENANCE OF TRAFFIC	6.00			\$27,631.21
101-1	MOBILIZATION	10.00			\$48,815.13
110-1-1	CLEARING & GRUBBING	3.90	AC	\$33,000.00	\$128,700.00
160-4	TYPE B STABILIZATION	9,386.67	SY	\$8.40	\$78,848.03
285-701	OPTIONAL BASE,BASE GROUP 01	7,040.00	SY	\$24.00	\$168,960.00
334-1-12	SUPERPAVE ASPHALTIC CONC, TRAFFIC B	528.00	TN	\$140.00	\$73,920.00
570-1-2	PERFORMANCE TURF, SOD	2,347.00	SY	\$4.30	\$10,092.10
999-25	INITIAL CONTINGENCY AMOUNT (DO NOT BID)	1.00	LS	\$26,848.32	\$26,848.32
<b>Project Unknowns</b>			0.00	%	\$0.00
<b>Design/Build</b>			0.00	%	\$0.00
<b>Version 17 Project Grand Total</b>					<b>\$563,814.79</b>

