

Parental Home Road

Corridor Study



Prepared for:



North Florida Transportation Planning Organization

980 North Jefferson Street
Jacksonville, FL 32209
(904) 306-7500 | www.northfloridatpo.com

Prepared by:

ATKINS

Member of the SNC-Lavalin Group

July 2021

Parental Home Road Corridor Study

Bowden Road to Beach Boulevard

Prepared for:



North Florida Transportation Planning Organization
960 North Jefferson Street
Jacksonville, FL 32209
(904) 306-7500 | www.northfloridatpo.com

Prepared by:

ATKINS

Member of the SNC-Lavalin Group

The preparation of this report has been financed in part through grants from the Federal Highway Administration and Federal Transit Administration, U.S. Department of Transportation, under the Metropolitan Planning Program, Section 104(f) of Title 23, U.S. Code. The contents of this report do not necessarily reflect the official views or policy of the U.S. Department of Transportation. The TPO does not discriminate in any of its programs or services. Public participation is solicited by the TPO without regard to race, color, national origin, sex, age, disability, family or religious status. Learn more about our commitment to nondiscrimination and diversity by contacting our Title VI/Nondiscrimination Coordinator, Marci Larson at (904) 306-7513 or mlarson@northfloridatpo.com.

TABLE OF CONTENTS

1.0 INTRODUCTION	1	3.0 NEEDS ANALYSIS	18
2.0 EXISTING CONDITIONS ANALYSIS	2	3.1 HISTORICAL SAFETY REVIEW (CRASH ANALYSIS).....	19
2.1 STUDY CORRIDOR DESCRIPTION.....	3	3.2 TRAFFIC ANALYSIS	23
2.2 DEMOGRAPHIC INDICATORS.....	4	3.3 TRAFFIC FORECASTING	23
2.3 GENERAL ROADWAY CHARACTERISTICS.....	5	3.4 NETWORK OPERATIONS ANALYSIS	26
2.4 CORRIDOR TYPICAL SECTION	5	3.5 CORRIDOR LEVEL OF SERVICE.....	26
2.5 STUDY INTERSECTIONS	10	3.6 INTERSECTION LEVEL OF SERVICE ANALYSIS.....	27
2.6 SIDEWALK FACILITIES.....	11	3.7 TRAVEL TIME PERFORMANCE.....	29
2.7 RAILROADS.....	12	4.0 PUBLIC INPUT.....	32
2.8 TRANSIT	12	5.0 PROPOSED CORRIDOR IMPROVEMENTS	34
2.9 RECENTLY COMPLETED PROJECTS IN THE AREA.....	13	6.0 CONCLUSION.....	44
2.10 PLANNED AND PROGRAMMED ROADWAY PROJECTS	13		
2.11 EXISTING LAND USE, ZONING, AND FUTURE LAND USE	14		
2.12 GENERAL ENVIRONMENTAL CHARACTERISTICS.....	17		

APPENDICES

- Appendix A: Traffic Data
- Appendix B: FDOT TREND’s Worksheets
- Appendix C: Travel time and Speed Data
- Appendix D: Survey Results

LIST OF FIGURES

FIGURE 2-1. STUDY AREA.....	3	FIGURE 2-9. EXISTING LAND USE	14
FIGURE 2-2 PARENTAL HOME ROAD DEMOGRAPHIC INDICATORS.....	4	FIGURE 2-10. ZONING.....	15
FIGURE 2-2. TYPICAL SECTION: NORTH OF HANZAS COURT	6	FIGURE 2-11. FUTURE LAND USE.....	16
FIGURE 2-3. TYPICAL SECTION: SOUTH OF DEAN ROAD	7	FIGURE 2-12. SURFACE WATERS AND WETLANDS.....	17
FIGURE 2-4 TYPICAL SECTION: SOUTH OF IBACH ROAD.....	8	FIGURE 3-1. CRASHES, 2015-2019.....	19
FIGURE 2-5 TYPICAL SECTION: SOUTH OF STARLING AVENUE	9	FIGURE 3-2 BICYCLE AND PEDESTRIAN CRASHES	20
FIGURE 2-6. STUDY INTERSECTIONS	10	FIGURE 4-1 BEST CHARACTERISTICS WORD CLOUD	32
FIGURE 2-7. SIDEWALK LOCATIONS.....	11	FIGURE 4-2 WORST CHARACTERISTICS WORD CLOUD.....	33
FIGURE 2-8 TRANSIT FACILITIES.....	12		

LIST OF TABLES

TABLE 3-1 HISTORIC TRAFFIC COUNTS.....	24	TABLE 3-7 2025 AND 2045 NO-BUILD	28
TABLE 3-2 REGRESSION ANALYSIS GROWTH RATE	24	TABLE 3-8 CORRIDOR TRAVEL TIME SUMMARY - AM.....	30
TABLE 3-3 POPULATION PROJECTIONS.....	25	TABLE 3-9 CORRIDOR TRAVEL TIME SUMMARY - MIDDAY	30
TABLE 3-4 GROWTH RATE SUMMARY	25	TABLE 3-10 CORRIDOR TRAVEL TIME SUMMARY - PM.....	30
TABLE 3-5 CORRIDOR LOS.....	26	TABLE 5-1 SUMMARY OF PROPOSED CORRIDOR IMPROVEMENTS.....	34
TABLE 3-6 2020 EXISTING	28		

ACRONYMS

COJ	City of Jacksonville
DDHV	Directional Design Hour Volumes
FDEP	Florida Department of Environmental Protection
FDOT	Florida Department of Transportation
FGDL	Florida Geographic Data Library
FHWA	Federal Highway Administration
HCM	Highway Capacity Manual
JTA	Jacksonville Transportation Authority
LOS	Level of Service
ROW	Right-of-Way
RRFB	Rectangular Rapid Flashing Beacon
S4	Signal 4 Analytics
TPO	Transportation Planning Organization
TSM&O	Transportation System Management and Operations
USEPA	United States Environmental Protection Agency

1.0 INTRODUCTION

The North Florida Transportation Planning Organization (TPO) conducted a study along Parental Home Road from Bowden Road to Beach Boulevard on behalf of the City of Jacksonville. The purpose of this study is to address both safety and mobility along the corridor. The study was conducted in partnership with the City of Jacksonville, the Florida Department of Transportation (FDOT), and the North Florida TPO to analyze the corridor and provide recommendations for future transportation improvements that align with the City of Jacksonville's Transportation Master Plan to better serve the residents of the City. The result is this report summarizing study efforts and recommendations for improvements of the corridor that will set the groundwork for the implementation of future projects.

This plan evaluated various features and characteristics of the roadway and the surrounding area including traffic data, land use data, crash data, intersection geometries, and bicycle and pedestrian facilities. By evaluating these corridor conditions, the project team was able to design a plan to increase safety and enhance multi-modal transportation along the corridor, including bicycle and pedestrian modes.

This document is organized into the following sections:

- ◆ [1.0 Introduction](#)
- ◆ [3.0 Needs Analysis](#)
- ◆ [4.0 Public Input](#)
- ◆ [2.0 Existing Conditions Analysis](#)
- ◆ [5.0 Proposed Corridor Improvements](#)
- ◆ [6.0 Conclusion](#)

This plan evaluates the current state of several aspects of the corridor, such as the urban design context of the area, traffic and transportation elements, and safety concerns in the area. Additionally, this plan provides a baseline to understand the impacts of the proposed improvements that were developed for the corridor. This plan incorporates Complete Streets concepts into the recommended design elements to ensure adequate space for all users and modes of transportation in a way that creates a more livable community and sense of place. The term "complete streets" is often used to define roadways that function in a multi-modal fashion, safely accommodating automobiles, transit vehicles and riders, bicyclists, and pedestrians. Streets are not just for moving people and vehicles, but also often serve as places for commerce and recreation. Complete streets also are compatible with the surrounding community, and support adjacent land uses and activities, in a contextually appropriate manner.

Through analysis, on-site reviews, and discussions with stakeholders, proposed recommendations have been developed to help mitigate some of the corridor's most pressing issues. The proposed recommendations put forth in this plan are intended to provide a robust menu of improvements that can be constructed over time when funding becomes available.

2.0 EXISTING CONDITIONS ANALYSIS

The existing conditions analysis included a review of existing infrastructure and the existing transportation system for the corridor. The purpose of the existing conditions analysis is to determine the adequacy of existing facilities using the following criteria: safety; connectivity; completeness of network; ability to serve commercial freight, recreational, and residential uses; barriers and constraints; ability to serve the needs of all types and users and proposed City of Jacksonville projects.



*Intersection of Barnes Road and Parental Home Road
Source: Study Team.*



*Stream at Parental Home Road adjacent to Drew Park
Source: Study Team.*

2.1 STUDY CORRIDOR DESCRIPTION

Parental Home Road is a north-south roadway located in Duval County, Florida. The study limits of the Parental Home Road Corridor Study are from Bowden Road to Beach Boulevard (US 90). It is functionally classified by FDOT as an **Urban Major Collector** and is approximately **1.95 miles long**. The local jurisdiction for the Parental Home Road Corridor is the City of Jacksonville. See **Figure 2.1** for the project study area limits.



FIGURE 2-1. STUDY AREA



2.2 DEMOGRAPHIC INDICATORS

Demographic indicators were summarized using the United States Environmental Protection Agency’s (USEPA) EJSCREEN tool. As described by the USEPA, EJSCREEN is an environmental justice mapping and screening tool that provides EPA with a nationally consistent dataset and approach for combining environmental and demographic indicators.

Six demographic indicators for the corridor were summarized with all indicators being close to the both the state of Florida average as well as the US averages. The low income population, linguistically isolated population, and population under age 5 were a few percentage points higher than the state of Florida and US averages. Also summarized was the demographic index which is based on the average of percent low-income and percent minority. **Figure 2-2** summarizes the demographic indicators.

FIGURE 2-2 PARENTAL HOME ROAD DEMOGRAPHIC INDICATORS

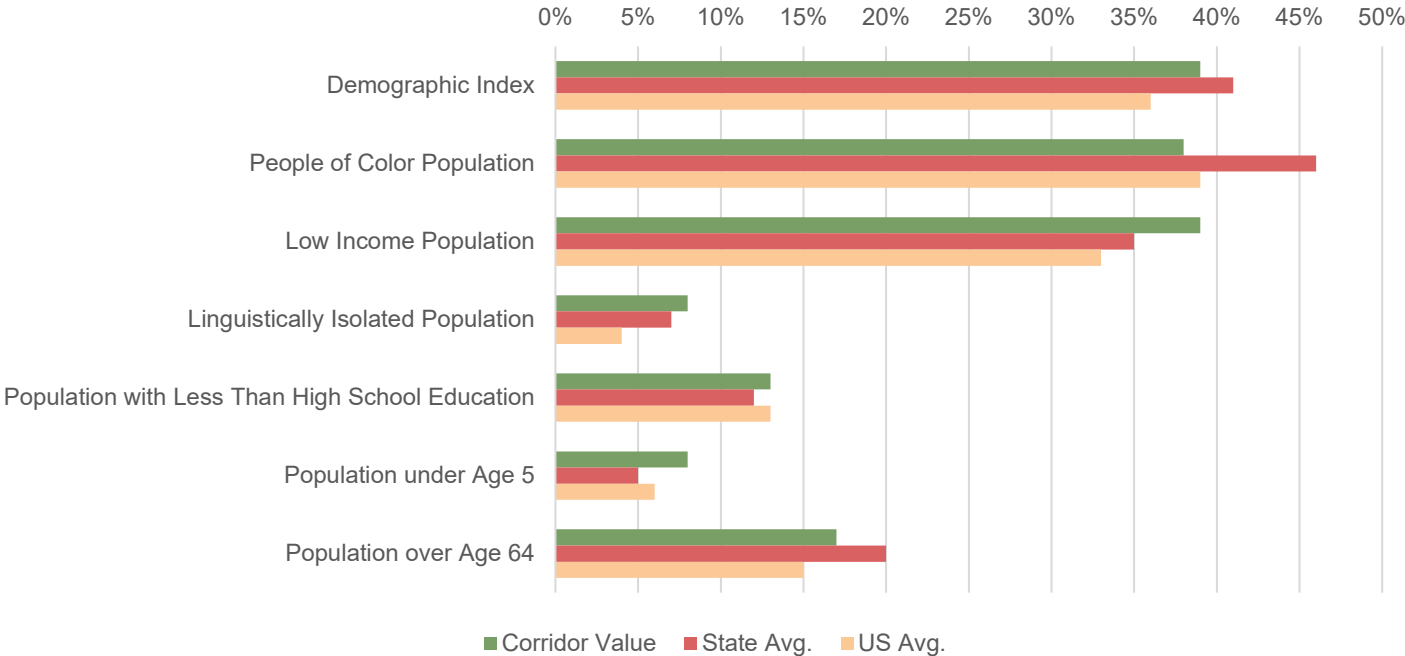

2.3 GENERAL ROADWAY CHARACTERISTICS

The following list summarizes the existing roadway characteristics for the Parental Home Road Study corridor:

- ◆ The FDOT functional classification of Parental Home Road is **Urban Major Collector**.
- ◆ Parental Home Road is within the **Urbanized Area** as classified by the Federal Highway Administration (FHWA).
- ◆ Parental Home Road is a **two-lane, undivided** facility.
- ◆ The posted speed limit along the corridor is **35 mph**.
- ◆ **Sidewalks** are present on at least one side along the length of the corridor.

2.4 CORRIDOR TYPICAL SECTION

The right-of-way of the corridor ranges from 60-feet to 73-feet. Drainage along the corridor is handled through a combination of curb and gutter, and swales. There is one travel lane in each direction along the corridor ranging from 11-to 12-feet in width. Where present, the sidewalk varies from 4 to 5 feet. A 14-foot left turn lane is present south of Dean Road and a 14-foot double left turn lane exists south of Starling Road.

Four typical sections for Parental Home Road are provided in Figures 2-2 through 2-5 for the following segments:

- ◆ North of Hanzas Court
- ◆ South of Dean Road
- ◆ South of Iback Road
- ◆ South of Starling Avenue

- ◆ There are no existing **on-road bicycle facilities** along the study corridor.
- ◆ **Crosswalks** are present at the major intersections along the corridor.
- ◆ There are **no school zones** along the corridor.
- ◆ **Street lighting** is present along portions of the corridor.



FIGURE 2-3. TYPICAL SECTION: NORTH OF HANZAS COURT



FIGURE 2-4. TYPICAL SECTION: SOUTH OF DEAN ROAD



FIGURE 2-5 TYPICAL SECTION: SOUTH OF IBACH ROAD



FIGURE 2-6 TYPICAL SECTION: SOUTH OF STARLING AVENUE



2.5 STUDY INTERSECTIONS

There are four (4) intersections included in the study listed below and displayed in **Figure 2.6**. An analysis of these intersections is included in the Needs Analysis section of this report.

- ◆ **Parental Home Road/Bowden Road:** The intersection of Parental Home Road and Bowden Road is a signalized three-way intersection. Parental Home is divided by a large, canopied median with a westbound left-turn lane. There are sidewalks on both sides of Parental Home Road and on the north side of Bowden Road. Additionally, signalized, painted crosswalks are present crossing Parental Home Road at this intersection.
- ◆ **Parental Home Road/Barnes Road South:** A signalized three-way intersection south of Jacksonville Drew Park with west and southbound left-turn lanes. Sidewalks are present at all intersection approaches. Painted, signalized crosswalks are present on the north and west sides of the intersection.
- ◆ **Parental Home Road/Dean Road:** A signalized Y-style two-way intersection with left-turn lanes in each direction. Sidewalks are present on the west side of Parental Home Road and on the south side of Dean Road. There is a painted, signalized crosswalk across Dean Road.
- ◆ **Parental Home Road/Hogan Road:** A signalized four-way intersection with left-turn lanes in all directions. Sidewalks are present on both sides at all four approaches. Painted, signalized crosswalks are present on the north, east, and west sides of the intersection.

FIGURE 2-7. STUDY INTERSECTIONS



2.6 SIDEWALK FACILITIES

Figure 2.7 displays the sidewalk locations along Parental Home Road (blue represents sidewalks on both sides, green represents sidewalks on one side). There are sidewalks on at least one side of the road throughout the extent of the corridor. Where there is a sidewalk on only one side of the road, it is located on the west side.



FIGURE 2-8. SIDEWALK LOCATIONS

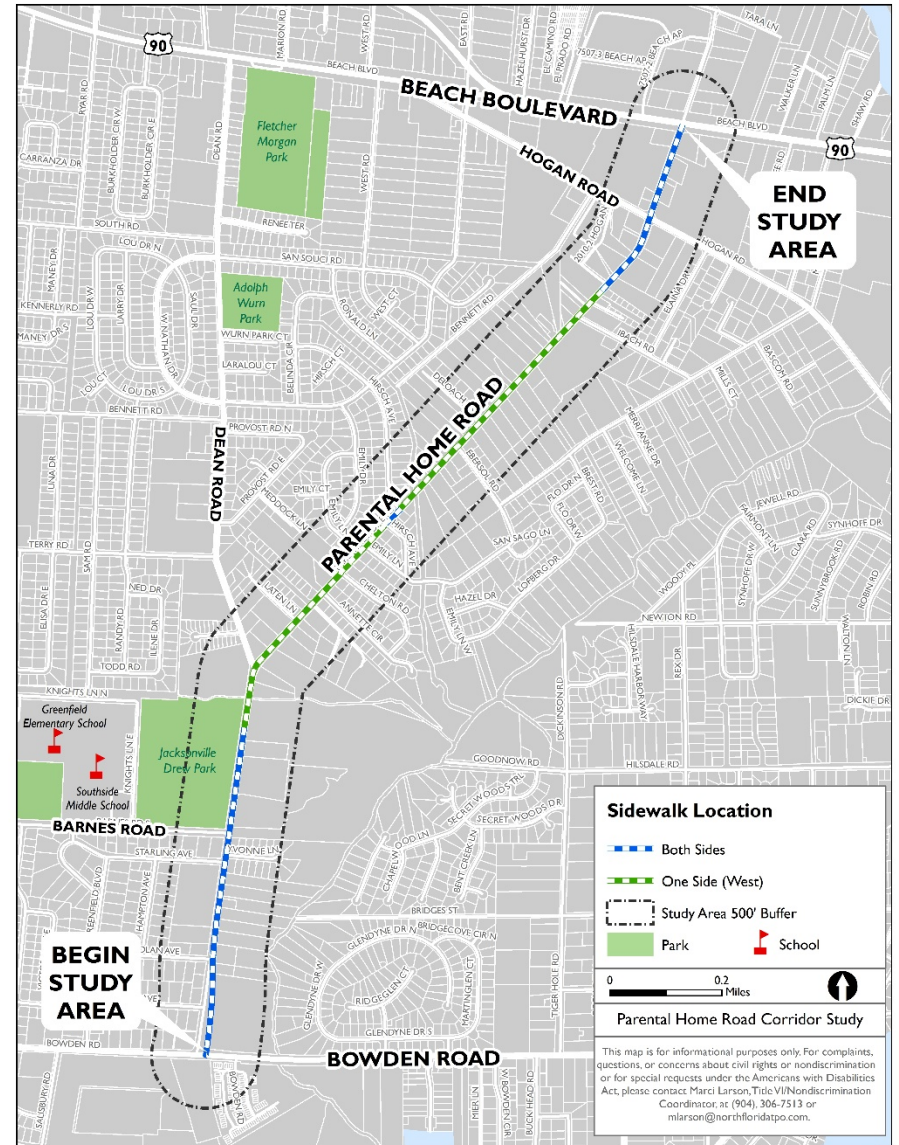



Parental Home Road North of Bowden Road. Source: Study



Parental Home Road bus stop across from Drew Park. Source: Study Team

FIGURE 2-9 TRANSIT FACILITIES



2.9 RECENTLY COMPLETED PROJECTS IN THE AREA

There have been no capacity or operational projects completed along the segment of Parental Home Road from Bowden Road to Beach Boulevard in recent years.

2.10 PLANNED AND PROGRAMMED ROADWAY PROJECTS

The FDOT recently completed a signal upgrade project on Beach Boulevard including the intersection with Parental Home Road. The project includes new mast-arms and signals at Beach Boulevard and Parental Home Road, Foster Drive, Grove Park Boulevard, Barkley Road, Peach Drive, Forest Boulevard, Anniston Road, DeSalvo Road, and Cortez Road. Other improvements include roadway lighting, sidewalk repairs, new highway signage, and the addition of a right turn lane from eastbound Beach Boulevard to Parental Home Road.



Hogan Road at Parental Home Road. Source: Study Team.

2.11 EXISTING LAND USE, ZONING, AND FUTURE LAND USE

EXISTING LAND USE

The generalized land use was determined using the 'Generalized Land Use Derived from 2019 Florida Parcels' dataset from the GeoPlan Center. This dataset was created for FDOT and generalizes 99 available land uses into 15 land use classifications.

As displayed in **Figure 2.9**, the corridor primarily consists of Residential (yellow) land use. There are some Commercial (red) land uses clustered around Beach Boulevard (US 90) and Hogan Road and some Institutional (pink) land uses along the corridor.



FIGURE 2-10. EXISTING LAND USE

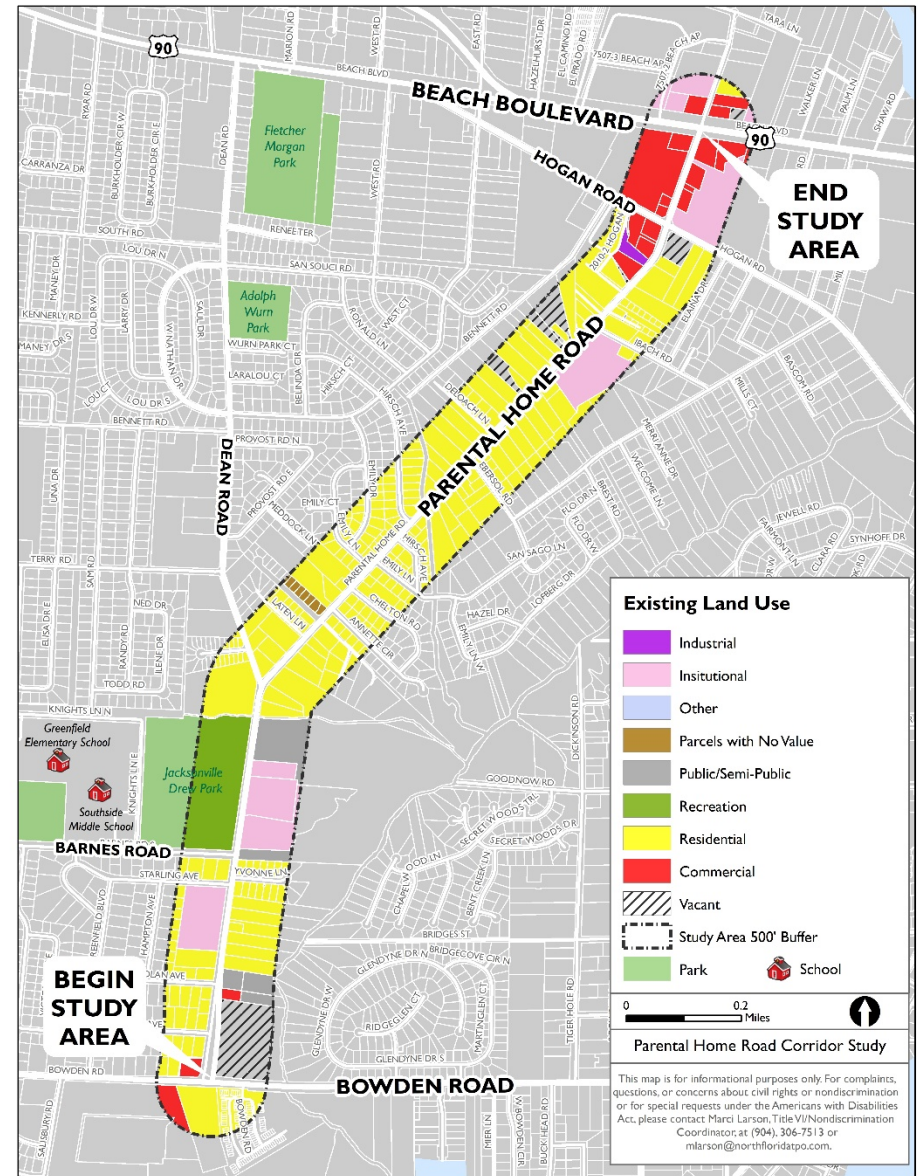

ZONING

Data was obtained from the City of Jacksonville (dated September 2019) and is displayed in **Figure 2.10**. The zoning categories were generalized based on the City of Jacksonville’s Zoning District summaries on their website.

The zoning along the corridor is primarily Low Density Residential (yellow), Commercial (red), or Commercial, Residential, Office (dark red). There is some Medium Density Residential zoning (orange) south of Hogan Road.

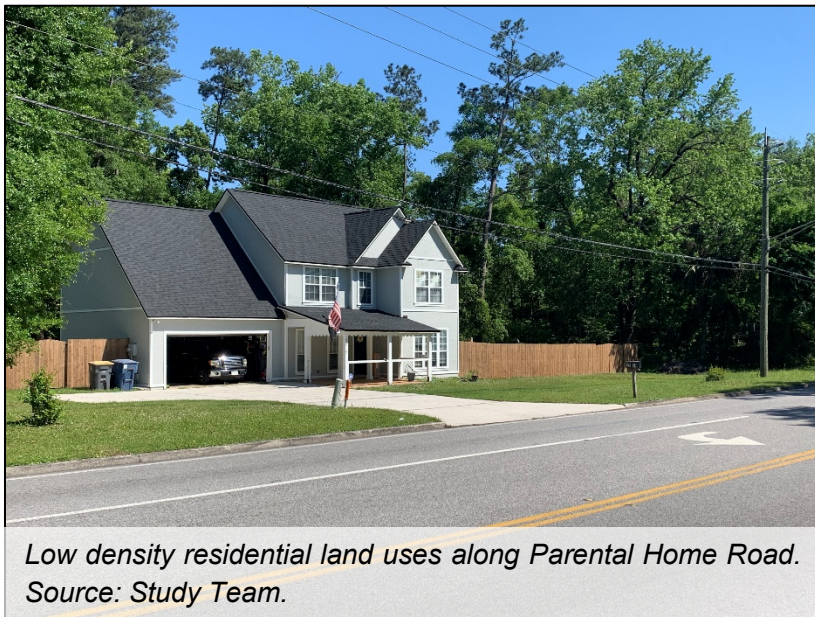
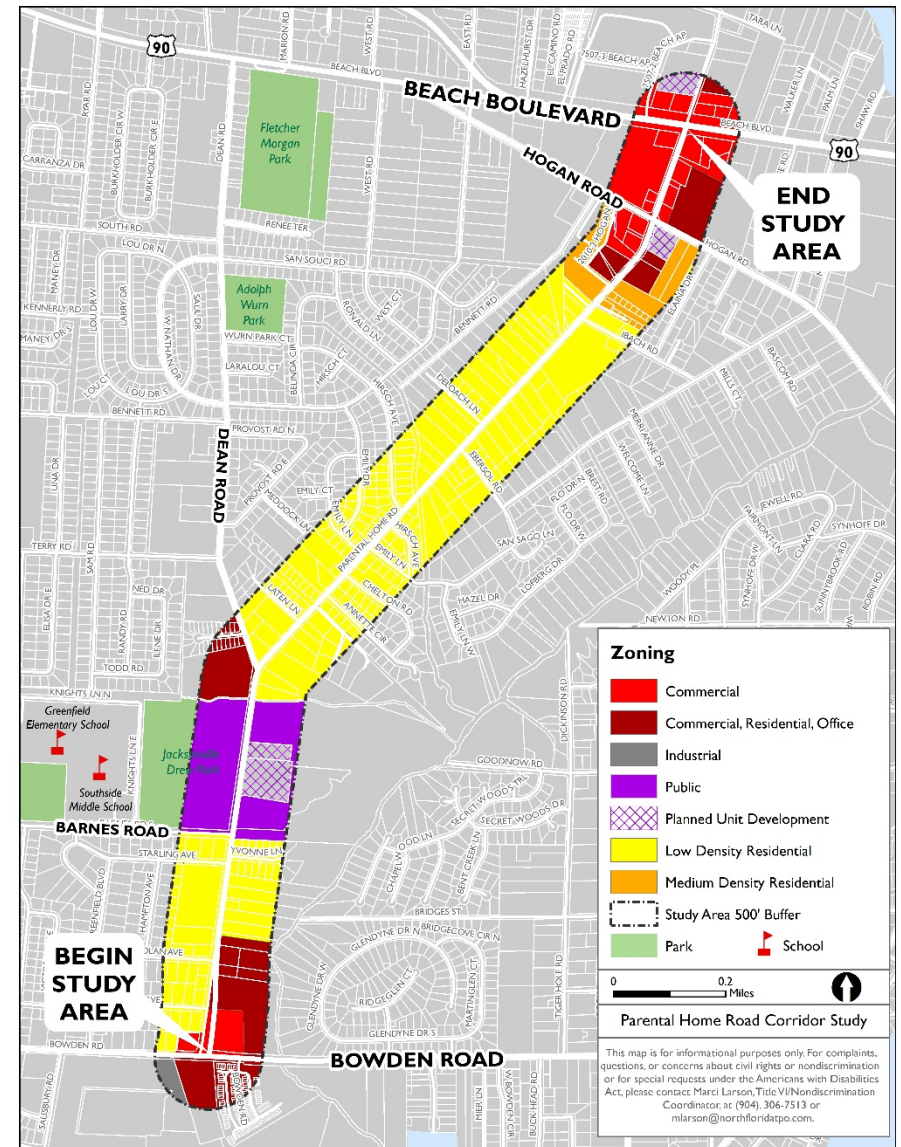

FIGURE 2-11. ZONING



FUTURE LAND USE

The future land use data was obtained from the City of Jacksonville (dated September 2019) and displayed in **Figure 2.11**. The future land use categories were generalized based on the City of Jacksonville’s 2030 Comprehensive Plan Land Use Category descriptions defined on their website.

The future land use along the study corridor is generally Low Density Residential (yellow) and Commercial (red). The Commercial areas are concentrated near the major intersections. The Low Density Residential uses are clustered along the central area of the corridor between Dean Road and south of Hogan Road.

Other future land uses along the corridor include Recreation and Open Space shown in green (Jacksonville Drew Park), Public Buildings and Facilities in purple, and some Medium-High Density Residential near Hogan Road.

The future land use to the immediate north and south of the study corridor is Commercial.

FIGURE 2-12. FUTURE LAND USE

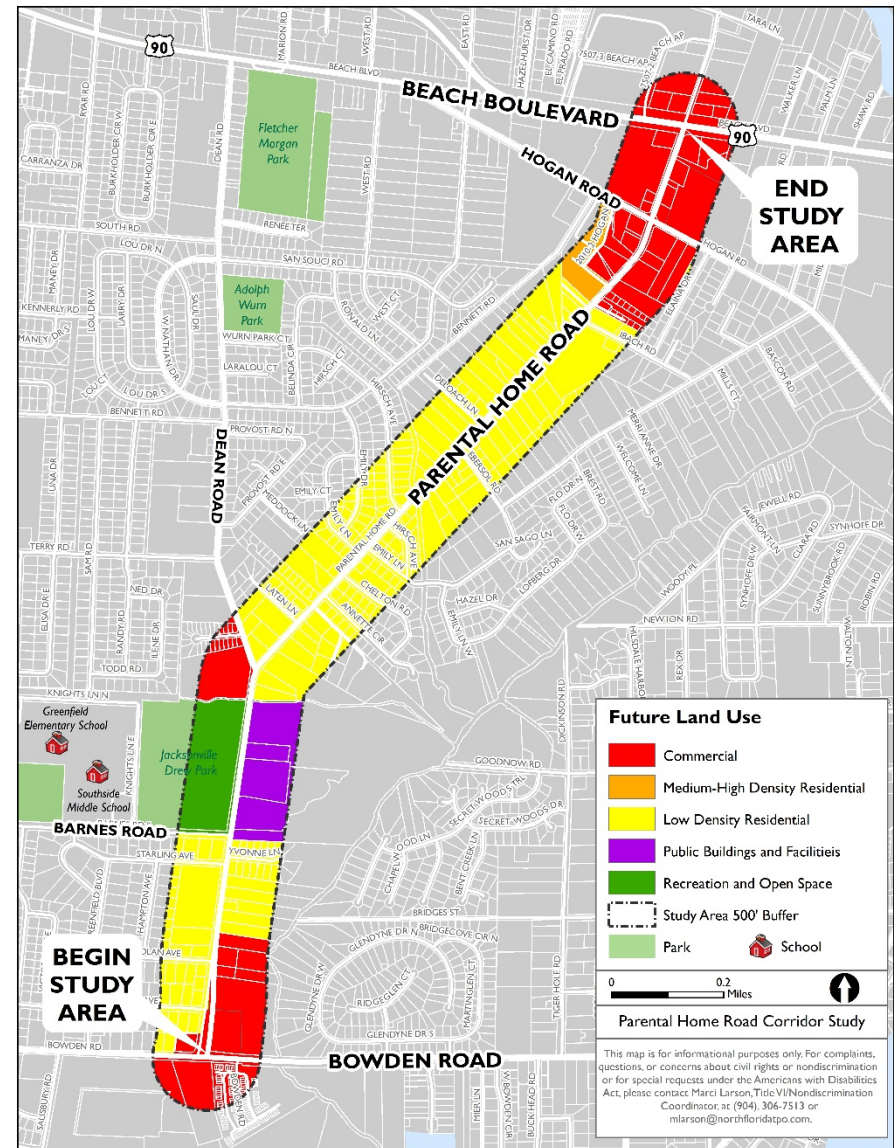

2.12 GENERAL ENVIRONMENTAL CHARACTERISTICS

General environmental characteristics for a 500-foot buffer along the corridor were documented including surface waters and wetlands, species and habitat, contamination, and cultural historic sites.

- ◆ **Surface Waters and Wetlands:** The surface waters and wetlands within the vicinity of the project area are shown in **Figure 2.12** using the *National Wetlands Inventory Polygons in Florida* dataset from U.S. Fish and Wildlife Services published on the Florida Geographic Data Library (FGDL) dated December 2019. The primary wetlands located within the vicinity of the project area are identified as Freshwater Forested/Shrub Wetland (dark teal).
- ◆ **Species and Habitat:** There were **no identified protected species and habitat** within the vicinity of the project area as indicated by the *Species Locations in the State of Florida* dataset from the University of Florida (UF) Geoplan Center published on FGDL, dated November 2013.
- ◆ **Contamination:** There were **no identified brownfield areas** within the project area as determined using the *Brownfield Areas in Florida* dataset from the Florida Department of Environmental Protection (FDEP) published on FGDL, dated July 2019.
- ◆ **Cultural Historic Sites:** There were **no identified cultural historic sites** within the project area as determined using the *Historical Structure Locations in Florida* dataset from the Bureau of Archaeological Research published on FGDL, dated April 2020.

FIGURE 2-13. SURFACE WATERS AND WETLANDS

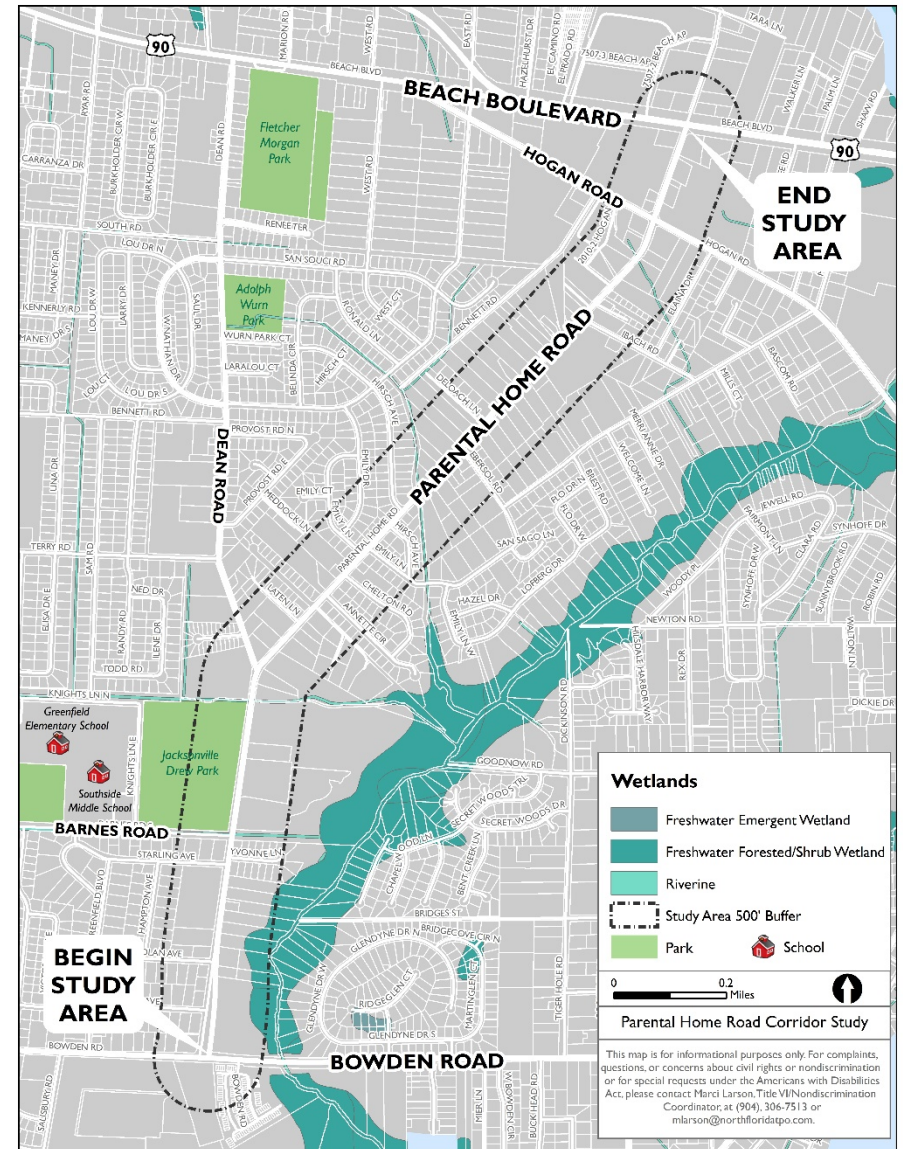

3.0 NEEDS ANALYSIS

A Needs Analysis was conducted to evaluate to mobility needs of the corridor. This analysis included an identification of operational and safety issues, and evaluation of the truck/freight movement needs, bicycle and pedestrian needs, and other relevant issues that arose during the study.



3.1 HISTORICAL SAFETY REVIEW (CRASH ANALYSIS)

A historical safety review was conducted in the form of a crash analysis using the Signal4 Analytics database to summarize corridor-wide and intersection crash trends from the previous complete five years (2015-2019) of crash data. A summary of the crash analysis is provided in this section. General crash trends are summarized below and further detailed in this section.

- ◆ There were **153 total** crashes ranging between 23 and 44 crashes per year with a yearly average of 31 crashes.
- ◆ **Sunday** had the highest frequency of crashes.
- ◆ None of the crashes resulted in **fatalities** and 61 of the crashes resulted in **injuries** (40%).
- ◆ There was one **bicycle** crash and two **pedestrian** crashes.
- ◆ 43% of the crashes occurred between **3 PM and 7 PM**.
- ◆ The top three **crash intersections** along the corridor were Hogan Road, Dean Road and Barnes Road.
- ◆ Over 50% of the crashes were front to rear-type crashes and 25% were angle-type crashes.
- ◆ Most crashes occurred during clear weather conditions, on dry roads in the daylight.

FIGURE 3-1. CRASHES, 2015-2019

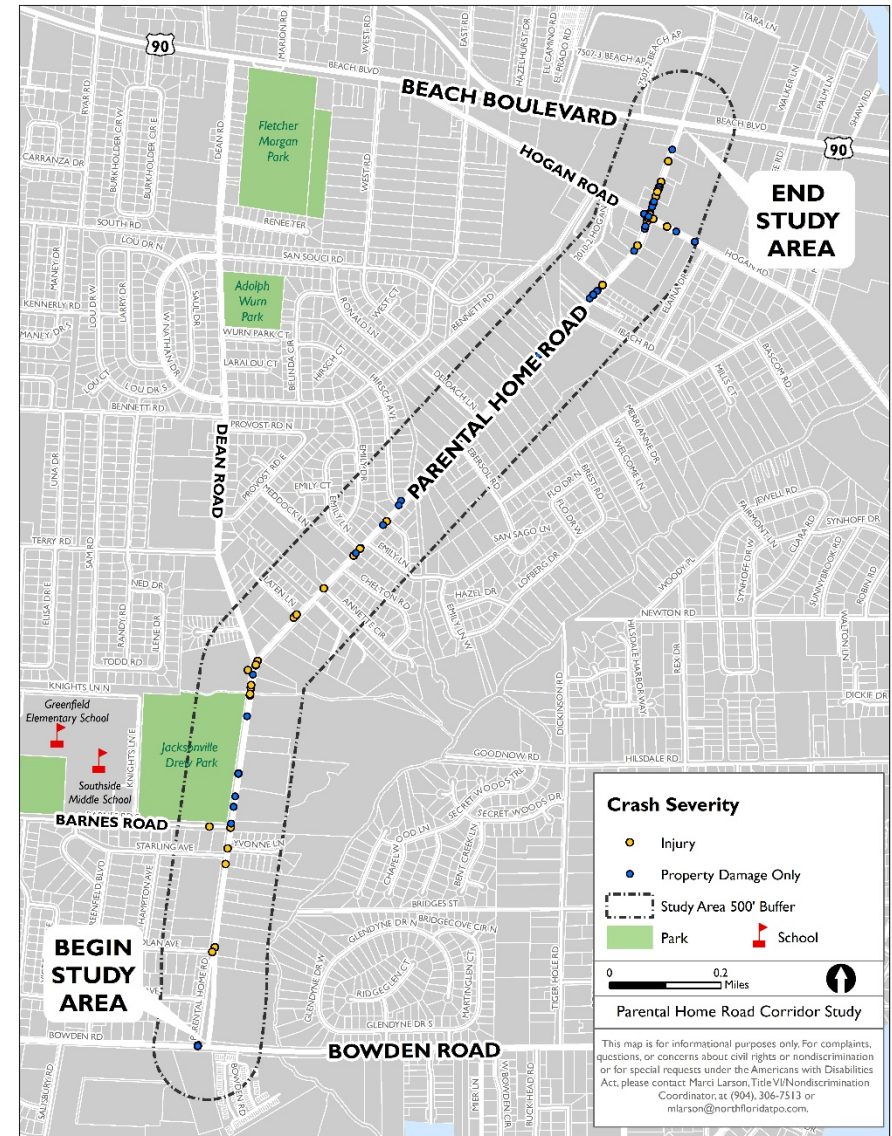

BICYCLE AND PEDESTRIAN CRASHES

Three of the crashes involved bicycles or pedestrians. Two of the bicycle or pedestrian involved crashes resulted with injury. Pedestrian and bicycle crashes are highlighted on the crash map.

- ◆ In April 2015 at approximately 9:00 AM a pedestrian attempted to cross Parental Home Road just north of Hogan Road. The pedestrian failed to yield to the vehicular right of way and was struck by a vehicle traveling southbound on Parental Home Road. At the time of the crash, the weather was clear and the pavement was dry.
- ◆ In December 2015 at approximately 6:45 AM, a bicyclist traveling on Parental Home Road was struck by a vehicle turning from Laten Road onto Parental Home Road. This crash occurred in the rain during unlit, dark conditions.
- ◆ In March 2016 at approximately 3:00 PM at the intersection of Parental Home Road and Dean Road, a vehicle making a southbound right from Dean Road struck a bicyclist traveling in the southbound crosswalk along Parental Home Road. This crash occurred in daylight hours while the pavement was wet. The driver was cited for failure to yield to pedestrians.

FIGURE 3-2 BICYCLE AND PEDESTRIAN CRASHES



CRASH YEAR

Overall, the number of crashes increased from 2015 to 2019 ranging from 23 to 44 crashes per year. The years 2015 and 2016 experienced the fewest number of crashes with 25 and 23 crashes each year, respectively. Crashes increased to 31 and 30 crashes each year for 2017 and 2018. The year 2019 saw the most crashes with 44 reported crashes for the year.

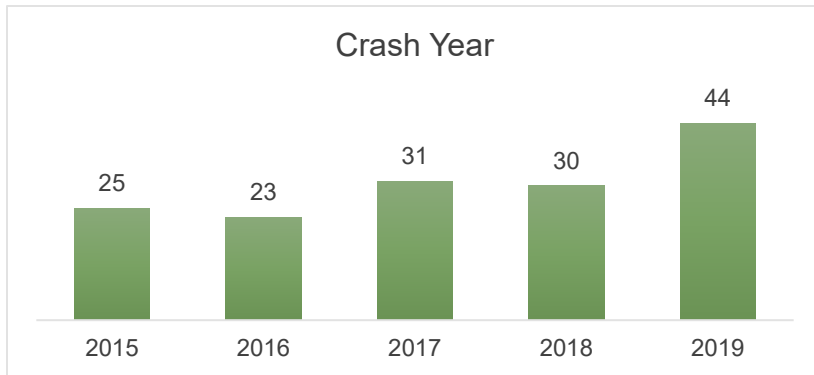

CRASH DAY OF THE WEEK

Sunday experienced the highest frequency of crashes with 34 crashes total (12%). Saturday experienced the fewest frequency of crashes with 15 crashes total (5%). Wednesday, Thursday, and Friday had similar crash frequencies ranging between 18 and 19 crashes (about 6% each).

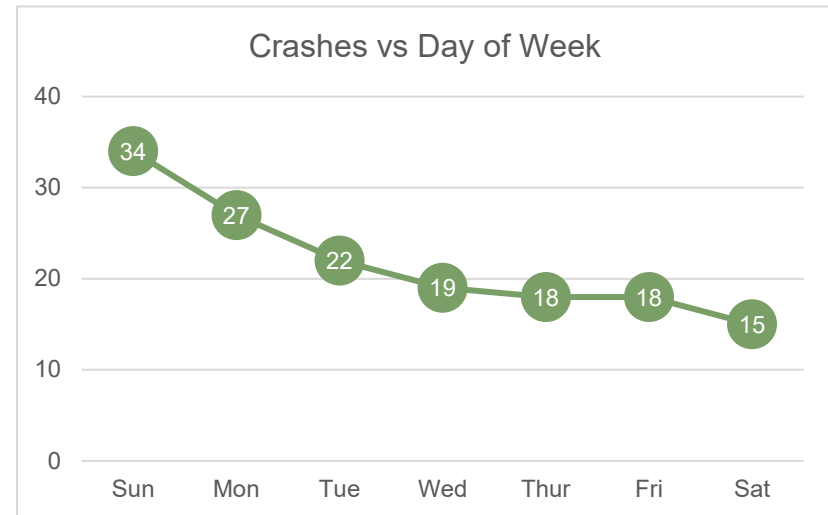

CRASH TIME OF DAY

Crash frequency was highest during the 8 AM hour (19 crashes) and 5 PM hour (9 crashes). Crash frequency was higher during the morning peak hours between 7 AM and 9 AM (22% of crashes) and the evening peak hours between 4 PM and 7 PM (41% of crashes). Zero crashes were reported between 3 AM and 6 AM.

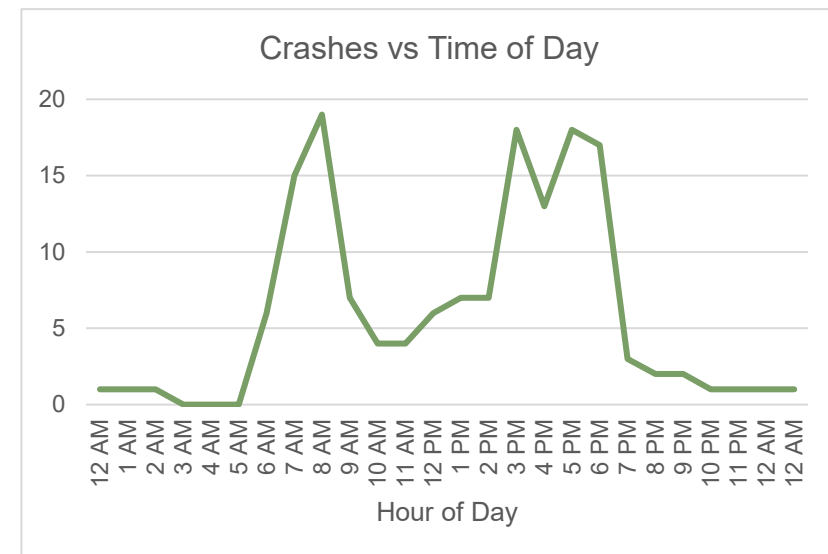

CRASH TYPE

The majority of the crashes were Front to Rear type crashes, with 80 crashes total (53% of crashes). Another 25% of the crashes were Angle type crashes. The least frequent types of crashes were Front to Front (4 crashes); Sideswipe, Opposite Direction (2 crashes), and Unknown (1 crash).

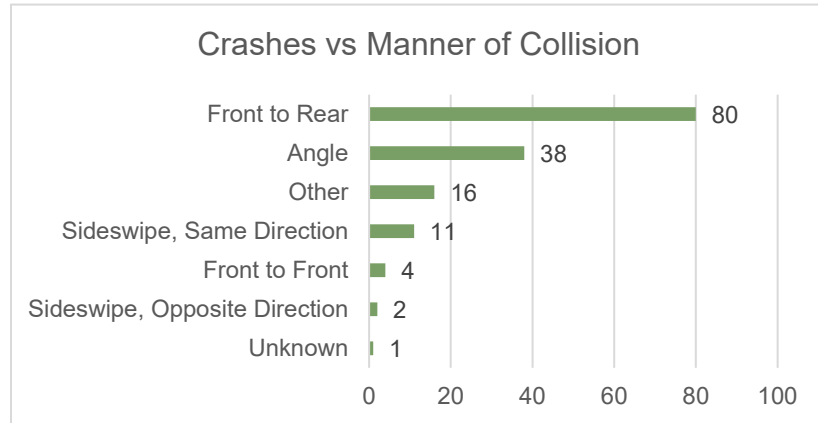

LIGHT CONDITIONS

Most of the crashes occurred during Daylight conditions (84%) or in Dark – Lighted conditions (10%). Approximately 4% of the crashes occurred in Dusk or Dawn conditions, and 2% occurred in Dark – Not Lighted conditions.

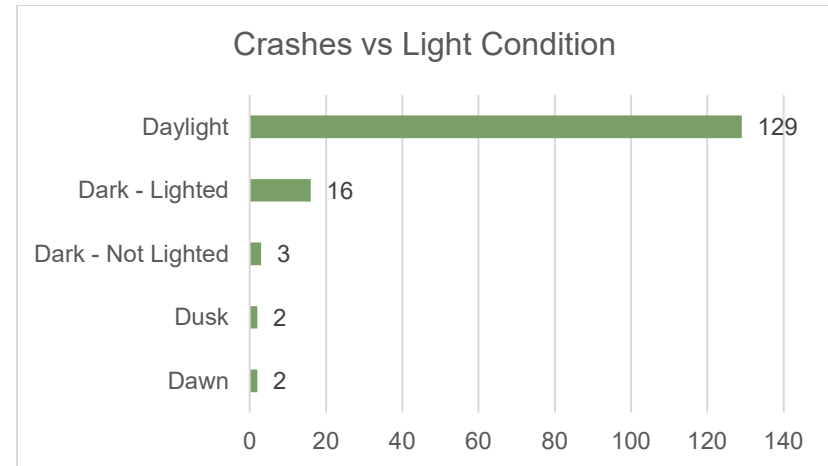

WEATHER CONDITIONS

A majority of the crashes occurred during Clear weather conditions (76%).

The remaining crashes occurred either in Cloudy (17%) or Rain (7%) weather conditions.

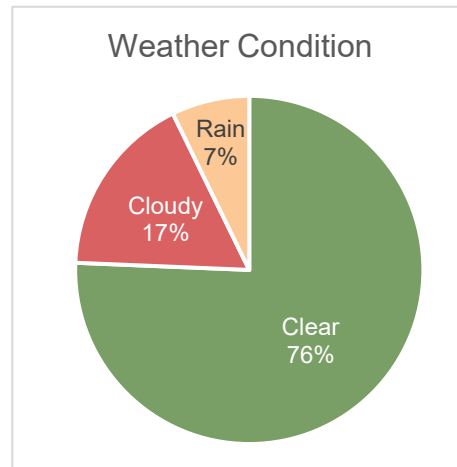

ROAD SURFACE CONDITION

A majority of the crashes occurred during Dry road surface conditions (86%). The remaining 14% of the crashes occurred during Wet road surface conditions.

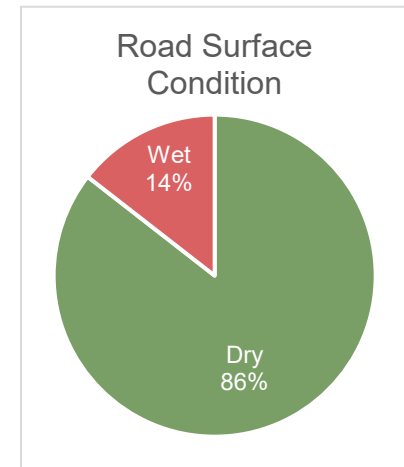

3.2 TRAFFIC ANALYSIS

Traffic analysis of the Parental Home Road Corridor was performed using a combination of traffic forecasting utilizing the regional planning model to estimate future travel and demand along the corridor in addition to a network operations analysis featuring a corridor and intersection level of service (LOS) analysis.

SEASONAL & TRAFFIC RECESSION DATA ADJUSTMENT FACTOR

Due to the overall decrease in daily traffic volumes caused by the COVID-19 pandemic, the September 2020 counts were adjusted to reflect pre-pandemic traffic levels. The turning movement counts were organized into two-way segment volumes for comparison to data obtained from FDOT's Florida Traffic Online database. Based on comparing the peak hour turning movement counts and Florida Traffic Online it was determined that to normalize the 2020 counts to historical levels the 2020 peak period turning movement counts should be applied a COVID-Adjustment Factor of 1.35 and the 24-hour machine count be applied a COVID-Adjustment Factor of 1.25.

Additionally, based on the time of year the counts were performed, the counts were adjusted by a 1.06 seasonal adjustment factor by incorporating the 2019 Duval County Season Factor Report.

24-HOUR MACHINE COUNTS

A three-day, 24-hour machine count was collected by Atkins from September 22-24, 2020 along Parental Home Rd south of Ibach Road. The count location determined the volume and direction of traffic traveling along Parental Home Road during an average weekday.

The average daily traffic reported after seasonal and COVID recession adjustments is 12,050 vehicles per day.

TURNING MOVEMENT COUNTS

The turning movement counts were collected for eight hours on Tuesday, September 15, 2020, by All Traffic Data Services. The count captured the AM, Midday, and PM peak periods. The TMCs included vehicle classification between passenger vehicles and heavy vehicles. Turning Movement counts were performed at the following four intersections:

- ◆ Parental Home Road & Bowden Road
- ◆ Parental Home Road & Barnes Road
- ◆ Parental Home Road & Dean Road
- ◆ Parental Home Road & Hogan Road

3.3 TRAFFIC FORECASTING

HISTORICAL TRAFFIC COUNTS

A ten-year historical trends analysis was performed using traffic count data for the most recently available AADT from FDOT's Florida Traffic Online database. Two locations were available within the study area and are listed below. The table below provides the annual count estimate along with the simple growth rate estimate comparison between 2010 (or earliest year of data) with 2019. The annual growth rate for these locations averaged between 1.01%-1.57% growth.

- ◆ Parental Home Road – North of Dean Road
- ◆ Parental Home Road – North of Bowden Road

TABLE 3-1 HISTORIC TRAFFIC COUNTS

Count Location	Count ID	2010	2011	2012	2013	2014	2015	2016	2017	2018	2019	Simple Growth Rate
North of Dean Road	729018	11,000	8,900	10,500	10,900	11,500	11,500	12,000	11,500	12,000	12,000	1.01%
.1 Mile North of Bowden Road	729229	n/a	n/a	10,900	10,900	10,900	11,100	11,300	11,700	11,900	12,100	1.57%

REGRESSION ANALYSIS USING HISTORICAL TRAFFIC DATA

The historical counts collected from FDOT's count program were then referenced to develop a Regression Analysis procedure used to project the 2045 design year volumes. This growth projection process assumes that the growth trend that occurred between 2010 and 2019 will be applicable for forecasting traffic in the year 2045. Based on this assumption the following growth rates were projected and range from 1.60% to 1.95%. The FDOT TRENDS worksheet was used to generate the growth rate projections between 2019 and 2045. The resulting forecast figures as well as the traffic data are provided in the appendix.

TABLE 3-2 REGRESSION ANALYSIS GROWTH RATE

Location	Regression Analysis Growth Rate
Parental Home Rd – North of Dean Rd	1.95%
Parental Home Rd – North of Bowden Rd	1.60%

POPULATION PROJECTIONS

The FDOT publishes population projections by county and by district on its Demographic Analysis Website. The population projection was collected for Duval County for all available years. The most recent available forecast data is for the years 2020 to

2045 in five-year increments adjusted based on the 2016 population estimates. The table below shows the population estimate for Duval County for Census Year 2010, Year 2016, and projections for years 2020 to 2045. The resulting annual growth rate between 2020 and 2045 is projected to be 1.0% per year.

TABLE 3-3 POPULATION PROJECTIONS

Location	2010	2016	2020	2025	2030	2035	2040	2045	Growth Rate
Duval County	864,263	923,647	975,500	1,035,100	1,089,300	1,138,500	1,179,900	1,218,700	1.0%

Source: FDOT Demographic Analysis Website https://fdotwww.blob.core.windows.net/sitefinity/docs/default-source/content/planning/fto/demographic/2045forecast.pdf?sfvrsn=45f3dab4_0

GROWTH RATE SUMMARY

To select a growth rate for recommendation all of the forecasts were compared to account for the variability in the different methods. The three methods of volume analytics are provided for

comparison in the table below. Based on the variability a suggested annual growth rate of 1.50% is proposed for the study area.

TABLE 3-4 GROWTH RATE SUMMARY

Location	10yr Historical Growth	FDOT Trends 2045	2045 County Pop. Growth	Suggested
North of Dean Rd	1.01%	1.95%	1.17%	1.50%
North of Bowden Rd	0.1%	0.9%	1.17%	1.50%

3.4 NETWORK OPERATIONS ANALYSIS

A network operations analysis was conducted for the Parental Home Road study area. This analysis was conducted to estimate future roadway segment and intersection traffic performance levels and identify locations where traffic operations become deficient.

3.5 CORRIDOR LEVEL OF SERVICE

The FDOT Quality Level of Service (LOS) tables were used to complete a planning-level analysis of the Parental Home Road segments.

The table below provides a summary of LOS classifications for the latest available 2019 through the forecasted 2045 traffic data.

Based on the segment analysis, the roadway LOS is expected to operate within acceptable limits for each segment in 2020, but the segments are both estimated to operate as LOS F at the design year 2045. While it is recognized that this roadway is forecasted to operate at a failing LOS (LOS F) in the year 2045, it is not recommended that Parental Home Road be widening, as this type of improvement would have a extremely negative effect on the adjacent neighborhood. Section 5.0 identifies alternative improvements that would have positive effects on the surrounding community and would be much less intrusive than the widening of the roadway.

TABLE 3-5 CORRIDOR LOS

Location	Suggested Annual Growth Rate	Service Volumes		2019		2025		2045	
		LOS D	LOS E	AADT	LOS	AADT	LOS	AADT	LOS
Parental Home Rd – North of Dean Rd	1.50%	14,060*	14,820	12,000	D	14,100	E	16,700	F
Parental Home Rd – North of Bowden Rd	1.50%	13,320*	14,040	12,100	D	13,300	D	16,800	F

3.6 INTERSECTION LEVEL OF SERVICE ANALYSIS

An operational analysis of the project's major intersections was performed for existing traffic and design years of 2025 and 2045. Directional Design Hour Volumes (DDHV) were developed for both the AM, midday, and PM peak periods at the study intersections. To develop DDHV and intersection movements the 2020 turning movement counts were adjusted based on the suggested annual growth rate.

The intersection traffic analysis was conducted using Synchro (version 11) traffic software, which uses the Highway Capacity Manual (HCM) methodology to determine intersection delay and LOS. Signal timings for future year signalized intersections were optimized using Synchro's optimization tool to achieve comparable intersection operating conditions and traffic progression to regular Transportation Systems Management and Operations (TSM&O) signal retiming maintenance.

An intersection peak hour operations analysis was performed for three scenarios with no infrastructure changes, for the existing year 2020, opening year 2025, and build design year 2045.

The results of the existing traffic analysis indicate that all intersections and movements currently operate within target LOS (LOS D or better) for existing and 2025 no build years. The 2045 No Build year analysis resulted in the Hogan Road and Bowden Road intersections operating below the target LOS at times.



Bowden Road at Parental Home Road. Source: Study Team.



Barnes Road at Parental Home Road. Source: Study Team.

TABLE 3-6 2020 EXISTING

Intersection	AM					Mid					PM				
	EB	WB	NB	SB	Overall	EB	WB	NB	SB	Overall	EB	WB	NB	SB	Overall
Hogan Rd	22.2 (C)	30.0 (C)	28.7 (C)	23.3 (C)	26.3 (C)	19.4 (B)	19.8 (B)	17.4 (B)	15.8 (B)	17.9 (B)	27.1 (C)	26.4 (C)	25.3 (C)	18.9 (B)	24.1 (C)
Dean Rd	18.4 (B)	--	7.1 (A)	15.3 (B)	12.5 (B)	13.7 (B)	--	5.2 (A)	11.8 (B)	9.3 (A)	17.3 (B)	--	7.4 (A)	15.4 (B)	11.7 (B)
Barnes Rd	24.0 (C)	--	5.7 (A)	19.0 (B)	15.5 (B)	14.7 (B)	--	3.7 (A)	8.5 (A)	7.8 (A)	18.5 (B)	--	5.5 (A)	11.6 (B)	10.3 (B)
Bowden Rd	15.3 (B)	26.0 (C)	--	31.6 (C)	25.5 (C)	8.8 (A)	15.9 (B)	--	23.2 (C)	15.6 (B)	14.0 (B)	23.4 (C)	--	27.9 (C)	20.3 (C)

TABLE 3-7 2025 AND 2045 NO-BUILD

Intersection		AM					Mid					PM				
		EB	WB	NB	SB	Overall	EB	WB	NB	SB	Overall	EB	WB	NB	SB	Overall
Hogan Rd	2025	23.8 (C)	36.5 (D)	31.7 (C)	26.8 (C)	30.2 (C)	19.6 (B)	20.0 (B)	18.6 (B)	16.7 (B)	18.6 (B)	30.4 (C)	30.0 (C)	28.2 (C)	21.1 (C)	27.0 (C)
	2045	36.8 (D)	125.4 (F)	40.9 (D)	36.2 (D)	61.2 (E)	21.9 (C)	22.4 (C)	23.4 (C)	21.0 (C)	22.2 (C)	57.5 (E)	57.8 (E)	58.7 (E)	32.2 (C)	50.8 (D)
Dean Rd	2025	18.4 (B)	--	7.1 (A)	15.3 (B)	12.5 (B)	14.3 (B)	--	5.4 (A)	12.4 (B)	9.7 (A)	18.7 (B)	--	8.3 (A)	16.5 (B)	12.7 (B)
	2045	20.1 (C)	--	8.1 (A)	16.5 (B)	13.7 (B)	17.5 (B)	--	6.8 (A)	14.9 (B)	11.9 (B)	26.7 (C)	--	18.7 (B)	29.4 (C)	23.5 (C)
Barnes Rd	2025	24.0 (C)	--	5.7 (A)	19.0 (B)	15.5 (B)	15.4 (B)	--	3.8 (A)	8.9 (A)	8.2 (A)	20.1 (C)	--	6.1 (A)	13.5 (B)	11.7 (B)
	2045	25.8 (C)	--	6.5 (A)	25.7 (C)	19.3 (B)	19.3 (B)	--	4.6 (A)	11.3 (B)	10.3 (B)	26.5 (C)	--	10.8 (B)	38.9 (D)	24.7 (C)
Bowden Rd	2025	15.3 (B)	26.0 (C)	--	31.6 (C)	25.5 (C)	9.6 (A)	17.3 (B)	--	23.7 (C)	16.4 (B)	18.1 (B)	26.2 (C)	--	30.7 (C)	23.8 (C)
	2045	17.5 (B)	29.4 (C)	--	37.4 (D)	29.7 (C)	13.5 (B)	24.1 (C)	--	30.2 (C)	21.9 (C)	27.1 (C)	58.7 (E)	--	93.5 (F)	54.5 (D)

LOS exceeds target LOS

3.7 TRAVEL TIME PERFORMANCE

Speed and travel time runs were conducted along Parental Home Road during the AM, Midday, and PM peak hours in both the northbound (NB) and southbound (SB) directions on Wednesday, December 9, 2020. These travel time runs took place when there was no inclement weather or traffic incidents that disrupt traffic flow. Five travel time runs in each direction (10 total) were performed during each analysis hour/period.

Each of the travel time collection periods was imported into the software program Tru-Traffic for analysis. Import methods consisted of manual importing from the GPS unit after the travel runs were recorded. **Tables 3-8 through 3-10** depict the summary outputs from the Tru-Traffic Software for each peak period. The appendix provides more detailed travel time and speed data for individual peak period runs.

Below are some key findings from the travel time data collection:

- The average travel time for all time periods is 3:38 (mm:ss) northbound and 3:45 (mm:ss) southbound
- Total travel delay is one minute or less for all time periods
- The average travel speed is 29.6 mph northbound and 29.2 mph southbound (Posted speed limit is 35 mph)
- The PM peak hour time period experiences the highest level of delay, average speed, and total number of stops

TABLE 3-8 CORRIDOR TRAVEL TIME SUMMARY - AM

Location	Travel Time (mm:ss)	Delay (ss)	Stopped Delay (ss)*	Average Speed (mph)	Average Number of Stops**
Parental Home Northbound	3:30	28	19	30.8	1.2
Parental Home Southbound	3:47	44	24	29.8	1.4

*Stopped Delay – The “Stopped Delay” time is counted from when the speed drops below 5 mph after exceeding 15 mph until it exceeds 15 mph once again

**Average Number of Stops – A “Stop” is counted when the speed drops below 5 mph after exceeding 15 mph

TABLE 3-9 CORRIDOR TRAVEL TIME SUMMARY - MIDDAY

Location	Travel Time (mm:ss)	Delay (ss)	Stopped Delay (ss)*	Average Speed (mph)	Average Number of Stops**
Parental Home Northbound	3:28	25	19	31.0	1.0
Parental Home Southbound	3:26	23	22	31.3	0.8

*Stopped Delay – The “Stopped Delay” time is counted from when the speed drops below 5 mph after exceeding 15 mph until it exceeds 15 mph once again

**Average Number of Stops – A “Stop” is counted when the speed drops below 5 mph after exceeding 15 mph

TABLE 3-10 CORRIDOR TRAVEL TIME SUMMARY - PM

Location	Travel Time (mm:ss)	Delay (ss)	Stopped Delay (ss)*	Average Speed (mph)	Average Number of Stops**
Parental Home Northbound	3:55	53	31	27.2	1.6
Parental Home Southbound	4:03	60	49	26.4	1.6

*Stopped Delay – The “Stopped Delay” time is counted from when the speed drops below 5 mph after exceeding 15 mph until it exceeds 15 mph once again

**Average Number of Stops – A “Stop” is counted when the speed drops below 5 mph after exceeding 15 mph

TRAFFIC ANALYSIS SUMMARY

Based on the analysis presented in this section, the results of the 2045 future analysis indicate that with the existing transportation infrastructure, the signalized intersection at Hogan Road will operate as LOS E overall during the AM peak, but the eastbound approach will fall to LOS F. The 2045 PM peak operations for the Parental Home and Homes Road intersection result with an overall LOS D but with the eastbound, westbound, and northbound approaches operating at LOS E. The Parental Home Road at Bowden Road intersection was estimated to operate as overall LOS D during the 2045 PM peak period, but the westbound and southbound approaches will operate as LOS E/F.



Hogan Road at Parental Home Road. Source: Study Team.



Dean Road at Parental Home Road. Source: Study Team.

4.0 PUBLIC INPUT

An online survey was administered via *SurveyMonkey* to solicit public input from the community about the study. The survey included 15 questions and was a mixture of multiple-choice, “yes” or “no”, ranking and open-ended questions. The survey was open for four weeks from May 10, 2021, to June 7, 2021, and received a total of 196 responses. The survey results are summarized below. The full survey results are provided in the appendix.

- A majority of the respondents would support additional **bicycle facilities** (81%) along Parental Home Road (81%). **Separated facilities were preferred** (71%) to on-road facilities (29%).
- Most of the respondents would support additional **pedestrian facilities** along Parental Home Road (80%).
- Additional **lighting** for the roadway and sidewalks was supported by a large majority of the respondents (91%).
- Some of the **best characteristics** of Parental Home Road were noted to be *trees, homes, neighborhoods, old, access, and beautiful* (see word cloud in **Figure 4-1**).
- *Speeding* and *Pedestrian Safety* were ranked as the two **most important transportation problems** along the segment.
- *Crossing the street at non-intersection locations* and *cut-through traffic* were ranked as the **two least important transportation problems** along the segment.

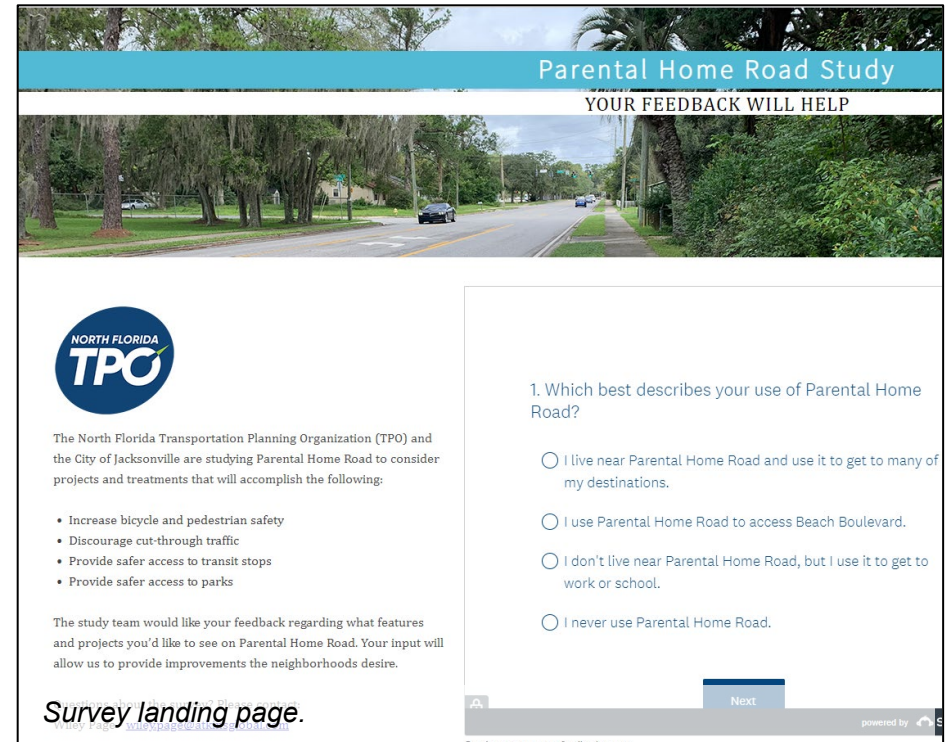

FIGURE 4-1 BEST CHARACTERISTICS WORD CLOUD



- Approximately 60% of the survey respondents indicated that **they would support traffic calming projects** such as narrowing travel lanes and/or raised or painted crosswalks.
 - Of these improvements, respondents ranked *raised crosswalks at limited locations* and a *roundabout at Parental Home Road and Dean Road* as the most important.
 - Of the respondents that indicated they would **not support** traffic calming projects, some of the reasons included: *I am the traffic and I don't want to be calmed; Speed bumps are annoying; The road is narrow enough*
- Some of the **worst characteristics** of Parental Home Road were noted to be *speeding, traffic, and sidewalks* (see word cloud in **Figure 4-2**).

“I am the traffic and I don't want to be calmed.”
– Question 10 Survey Response

- A majority of the respondents (66%) live near Parental Home Road and use it to get to many of their destinations. About 20% of the respondents use Parental Home Road to access Beach Boulevard.
- Most of the respondents indicated that they *Never* walk or bike on Parental Home Road (52%). Approximately 20% of the respondents walk or bike on Parental Home Road at least once a week.

FIGURE 4-2 WORST CHARACTERISTICS WORD CLOUD

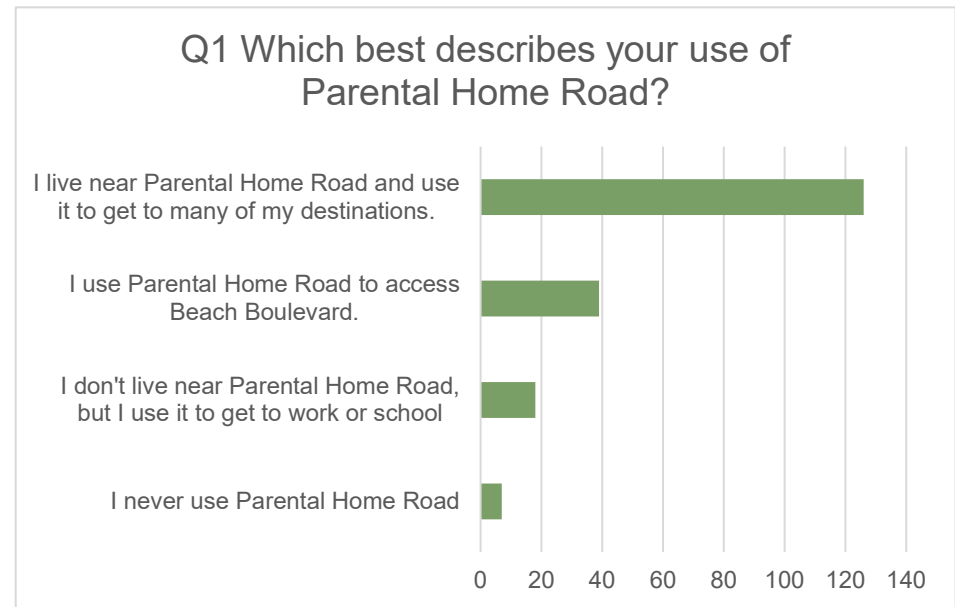
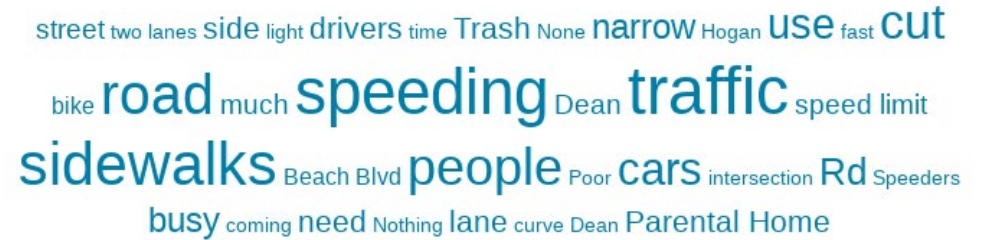

- Approximately 73% of the respondents use Parental Home Road at least a few times per week.
- Almost all of the respondents (95%) use a **private vehicle** while traveling on Parental Home Road.

5.0 PROPOSED CORRIDOR IMPROVEMENTS

As a result of the Existing Conditions Analysis and Needs Analysis, a set of proposed corridor improvements were developed. The proposed corridor improvements are summarized in **Table 5-1** and briefly described in this section. These improvements are intended

to make Parental Home Road safer for all users. Additionally, generalized planning cost estimates are provided for the proposed improvements.

TABLE 5-1 SUMMARY OF PROPOSED CORRIDOR IMPROVEMENTS

Improvement	Estimated Cost
Install High-Emphasis Crosswalks at Hogan Road, Barnes Road, and Bowden Road	\$8,000
Intersection Improvements at Bowden Road	\$10,000
Install Crosswalk and Pedestrian Signal on Northbound Approach to Hogan Road	\$12,500
Install a Rectangular Rapid-Flashing Beacon (RRFB) and raised crosswalk at Drew Park	\$50,000
Install Additional Overhead Directional Signage at Parental Home Road and Beach Boulevard	\$15,000
Construct Neighborhood Traffic Circle at Dean Road Intersection	\$45,000-\$150,000
Construct Separated Dual-Track Bike Lane from Bowden Road to Dean Road	\$75,000
Construct a Shared-Use Path Along Parental Home Road	\$350,000 (not including drainage improvements)

PROPOSED CORRIDOR IMPROVEMENTS

Install High-Emphasis Crosswalks at Hogan Road, Barnes Road, and Bowden Road

It is recommended that the crosswalks at Hogan Road, Barnes Road, and Bowden Road be repainted and changed to high-emphasis crosswalks. High emphasis crosswalks increase driver awareness allowing for quicker recognition of the crossing location.

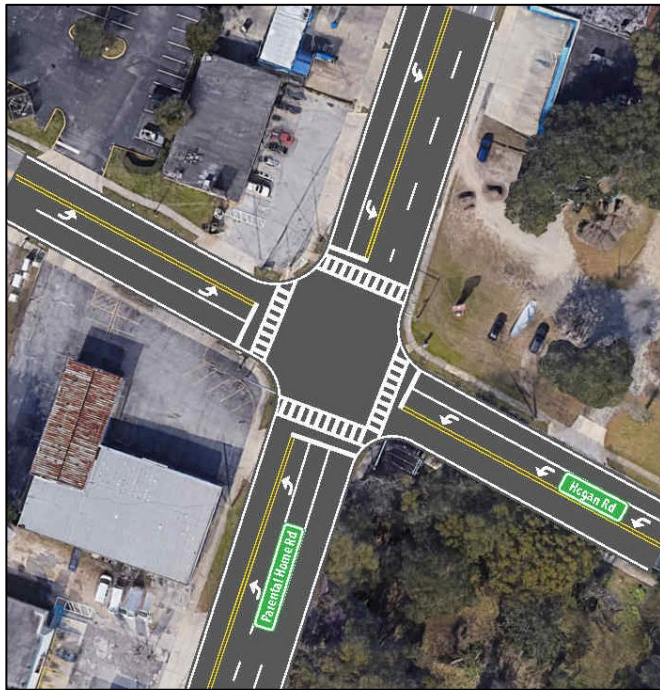

Proposed Improvements – Hogan Road Intersection



Proposed Improvements – Barnes Road Intersection



Proposed Improvements – Bowden Road Intersection

PROPOSED CORRIDOR IMPROVEMENTS
Intersection Improvements at Bowden Road

In addition to repainting the existing crosswalks as high emphasis crosswalks at the Bowden Road intersection, it is recommended that a “skip-stripe” be installed on the eastbound to northbound movement of the intersection. This will aid motorists making that movement, so they do not mistakenly turn onto the southbound lanes of Parental Home Road.

Furthermore, it is recommended that the existing sidewalks be extended along the south side of Bowden Road and that a new crosswalk be installed on the westbound approach to the intersection. This will allow pedestrians traveling on the south side of Bowden Road to connect to each sidewalk without requiring the removal of the large oak trees that are present in the area.

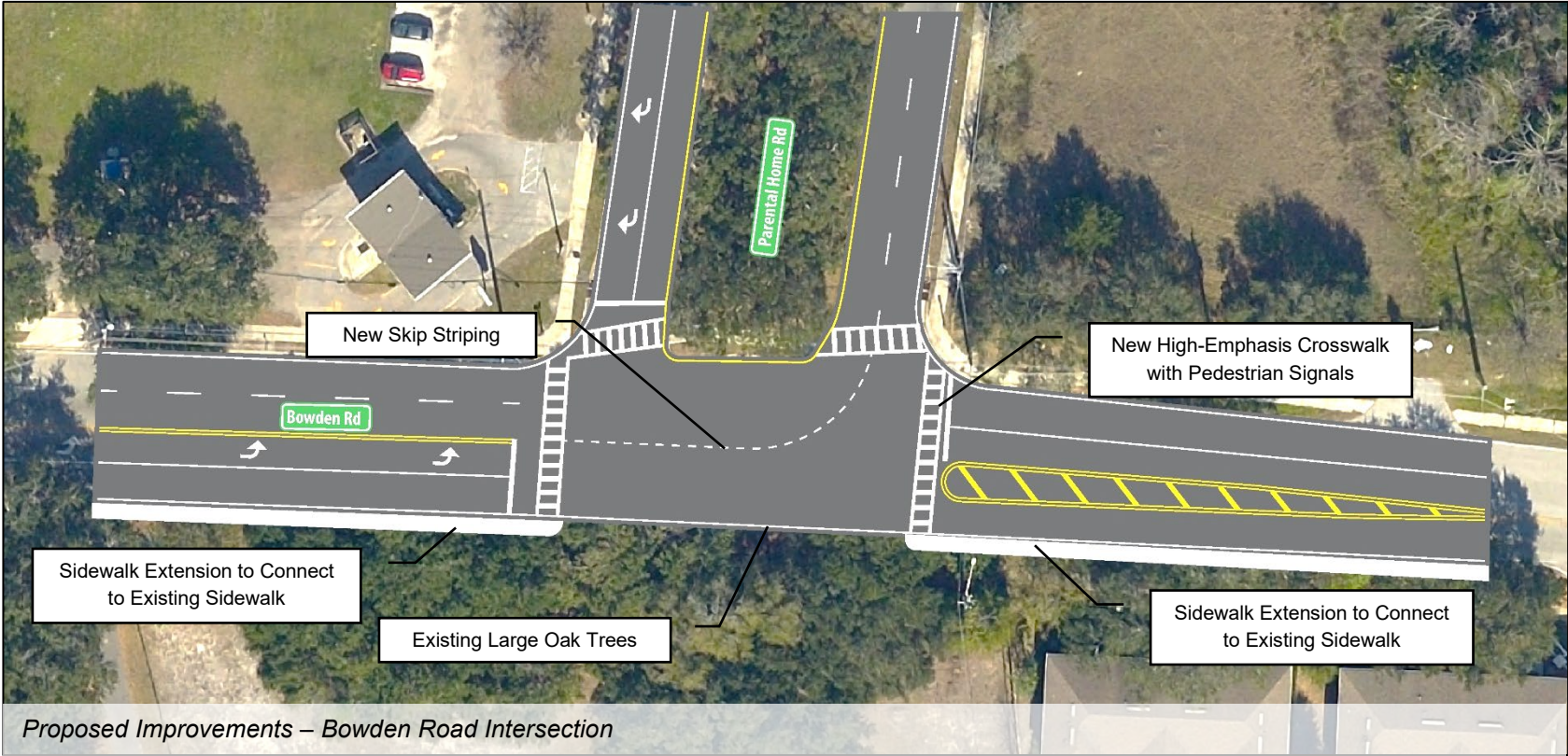

PROPOSED CORRIDOR IMPROVEMENTS

Install Crosswalk and Pedestrian Signal on Northbound Approach to Hogan Road

There is currently no crosswalk at this approach. This intersection experiences the highest number of pedestrian crossings of all intersections along the corridor. Because of this, the intersection should have crosswalks and pedestrian signals on all approaches. It is recommended that a new high emphasis crosswalk with pedestrian signals be installed on the southern leg of the intersection of Hogan Road.

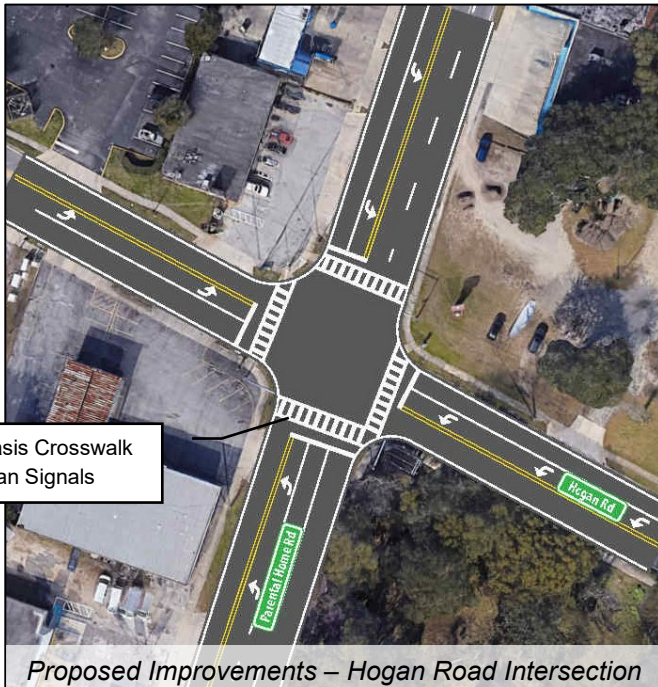

PROPOSED CORRIDOR IMPROVEMENTS

Install a Rectangular Rapid-Flashing Beacon (RRFB) and raised crosswalk at Drew Park

Drew Park is a popular recreational facility located on the west side of Parental Home Road with the southeastern-most portion of the park located at the intersection of Barnes Road. Near the entrance to the park, on the east side of Parental Home Road is a JTA bus stop. Also located on the east side of the road are River Region Human Services and Daniel Memorial. This bus stop is located approximately 600 feet north of the Barnes Road intersection. It is

proposed that a Rectangular Rapid-Flashing Beacon (RRFB) be installed at the location of this bus stop. In addition, it is recommended that a raised crosswalk be installed. This will provide safe and efficient east-west movements for individuals. The raised crosswalk would act as a speed table, thus provided traffic calming in this area.



Rendering of Proposed RRFB and Raised Crosswalk near the entrance of Drew Park

PROPOSED CORRIDOR IMPROVEMENTS***Install Additional Overhead Directional Signage at Parental Home Road and Beach Boulevard***

The northbound approach to Beach Boulevard at the intersection of Parental Home Road currently has dual westbound left-turn lanes. The inside left turn lane allows vehicles to access the Hart Expressway and the outside left turn lane allows vehicles to continue on Beach Boulevard. The barrier separating the Hart Expressway Ramp from Beach Boulevard is approximately 750 feet from the Parental Home Road intersection. While it is possible for vehicles on the inside lane to shift to the outside lane and vice versa, this creates an unsafe weaving pattern- particularly during peak hours. It is recommended that additional signage be installed to advise vehicles in the northbound left-turn lanes which lane they should be in based on their destination.



Rendering of Potential New Signage at Parental Home Road and Beach Boulevard

PROPOSED CORRIDOR IMPROVEMENTS***Construct Neighborhood Traffic Circle at Dean Road Intersection***

The existing configuration of the intersection of Parental Home Road and Dean Road is an offset skew. This creates safety issues due to sight distance limitations in both the northbound and southbound directions. It is recommended that a neighborhood traffic circle be constructed in this location. A neighborhood traffic circle would slow traffic through the intersection which would, in turn, improve safety. The construction of a traffic circle would require the acquisition of some ROW and may require the movement of a residential driveway. Neighborhood traffic circles provide substantial safety and operational benefits compared to other intersection types, most notably a reduction in severe crashes. According to the Highway Safety Manual, the conversion of a signalized intersection to a neighborhood traffic circle (or roundabout) can result in a 78% reduction in severe crashes.



Existing Dean Road intersection.

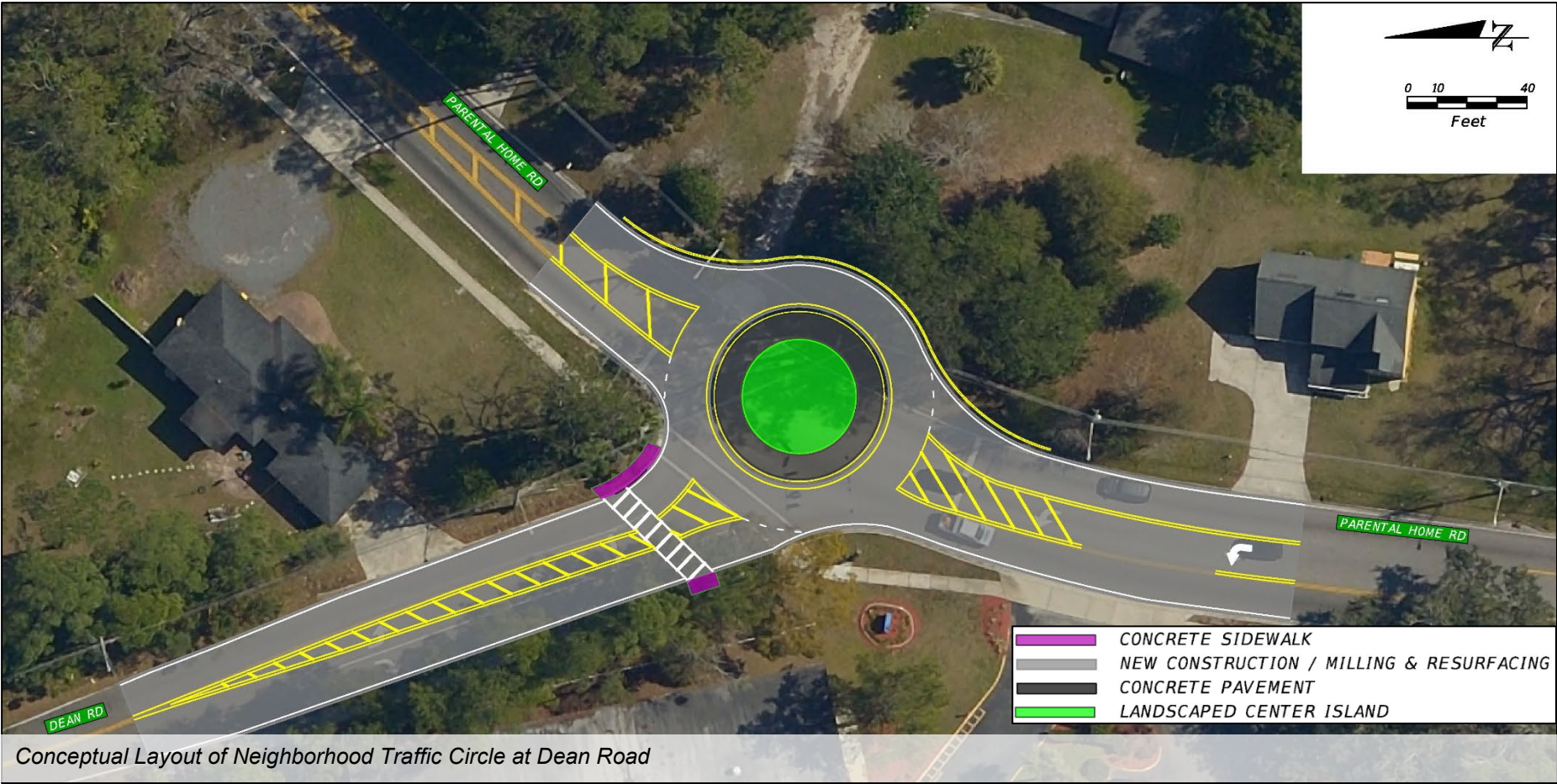

PROPOSED CORRIDOR IMPROVEMENTS**Construct Separated Dual-Track Bike Lane from Bowden Road to Dean Road**

While the segment of Parental Home Road from Bowden Road to Dean Road currently has sidewalks, it does not have any dedicated bicycle facilities. Currently, Parental Home Road is a two-lane facility that transitions to a three-lane facility which changes to a two-lane facility at Dean Road. It is recommended that one of these lanes be repurposed to include a dual-track bike lane from Bowden Road to Dean Road. The COJ Pedestrian and Bicycle Master Plan identifies Parental Home Road/Dean Road on its study network as Bike Plan Project #114 (Priority #159). This improvement would be the first segment of that project.



Rendering of a Dual-Track Bike Lane on Parental Home Road

PROPOSED CORRIDOR IMPROVEMENTS

Construct a Shared-Use Path Along Parental Home Road

While Parental Home Road currently has at least one sidewalk along the entirety of the corridor, there are some areas where the sidewalks are too narrow and/or damaged. It is recommended that a 12' shared-use path be constructed. This would allow bicyclists and pedestrians to use the corridor on a facility separated from the roadway. It should be noted that in some areas the shared-use path may have to cross to the other side of the street. At these locations, it is recommended that an RRFB be installed. This improvement would require drainage improvements including the installation of curb and gutter.

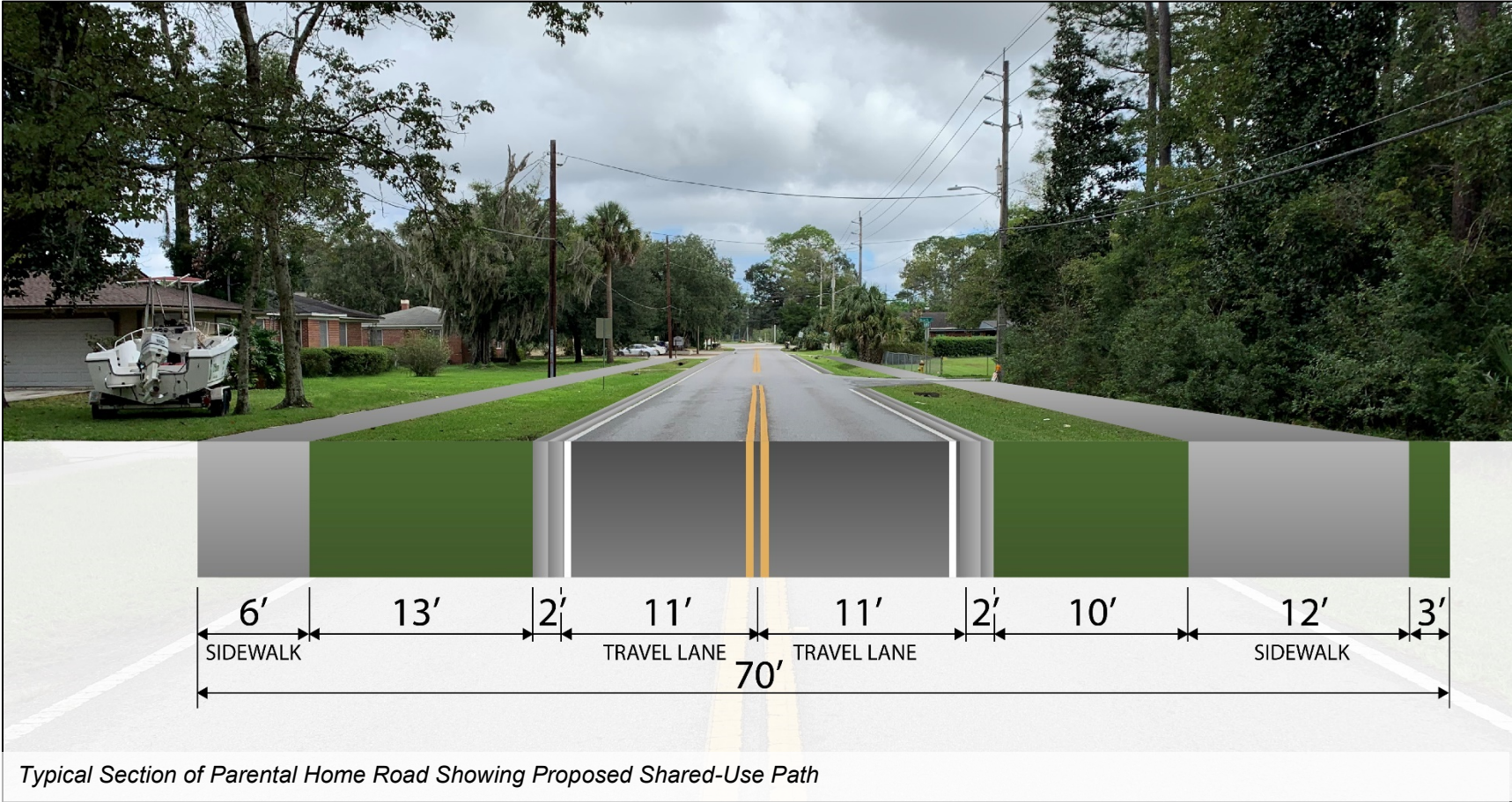

6.0 CONCLUSION

It is the goal of this corridor study is to provide recommendations and that will improve Parental Home Road as well as the surrounding community. These recommendations have been provided to help to revitalize the corridor as well as make it safer for all users. Many of the recommendations discussed could be completed incrementally as funding becomes available.



Appendix A

Traffic Data

Peak Hour - Motorized Vehicles

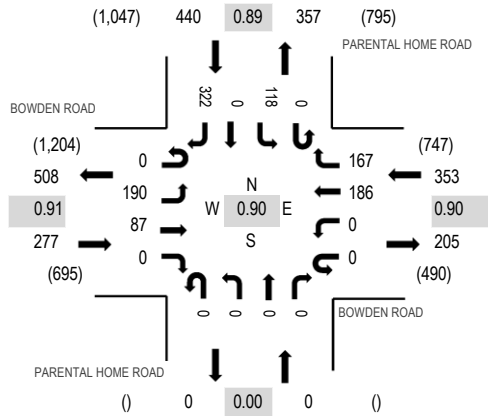

Peak Hour - Pedestrians/Bicycles in Crosswalk

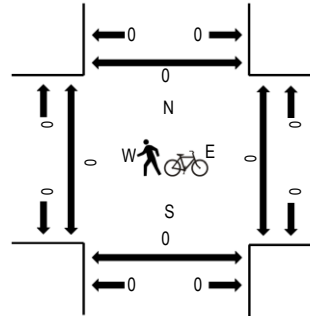

Note: Total study counts contained in parentheses.

Traffic Counts - Motorized Vehicles

Interval Start Time	BOWDEN ROAD Eastbound				BOWDEN ROAD Westbound				PARENTAL HOME ROAD Northbound				PARENTAL HOME ROAD Southbound				Total	Rolling Hour	Pedestrian Crossings			
	U-Turn	Left	Thru	Right	U-Turn	Left	Thru	Right	U-Turn	Left	Thru	Right	U-Turn	Left	Thru	Right			West	East	South	North
6:00 AM	0	23	6	0	0	0	10	5	0	0	0	0	0	10	0	24	78	519	0	0	0	0
6:15 AM	0	28	8	0	0	0	14	5	0	0	0	0	0	8	0	54	117	631	0	0	0	0
6:30 AM	0	19	15	0	0	0	24	13	0	0	0	0	0	14	0	52	137	772	0	0	0	0
6:45 AM	0	36	13	0	0	0	40	27	0	0	0	0	0	17	0	54	187	915	0	0	0	0
7:00 AM	0	33	13	0	0	0	36	18	0	0	0	0	0	19	0	71	190	1,024	0	0	0	0
7:15 AM	0	52	16	0	0	0	49	40	0	0	0	0	0	30	0	71	258	1,070	0	0	0	0
7:30 AM	0	41	27	0	0	0	53	45	0	0	0	0	0	27	0	87	280	1,040	0	0	0	0
7:45 AM	0	52	27	0	0	0	53	40	0	0	0	0	0	32	0	92	296	1,014	0	0	0	0
8:00 AM	0	45	17	0	0	0	31	42	0	0	0	0	0	29	0	72	236	946	0	0	0	0
8:15 AM	0	49	26	0	0	0	34	22	0	0	0	0	1	29	0	67	228		0	0	0	0
8:30 AM	0	41	31	0	0	0	36	39	0	0	0	0	1	23	0	83	254		0	0	0	0
8:45 AM	0	47	30	0	0	0	40	31	0	0	0	0	0	23	0	57	228		1	0	1	0

Peak Rolling Hour Flow Rates

Vehicle Type	Eastbound				Westbound				Northbound				Southbound				Total
	U-Turn	Left	Thru	Right	U-Turn	Left	Thru	Right	U-Turn	Left	Thru	Right	U-Turn	Left	Thru	Right	
Articulated Trucks	0	0	0	0	0	0	0	1	0	0	0	0	0	0	0	1	2
Lights	0	179	82	0	0	0	186	161	0	0	0	0	0	116	0	313	1,037
Mediums	0	11	5	0	0	0	0	5	0	0	0	0	0	2	0	8	31
Total	0	190	87	0	0	0	186	167	0	0	0	0	0	118	0	322	1,070

Peak Hour - Motorized Vehicles

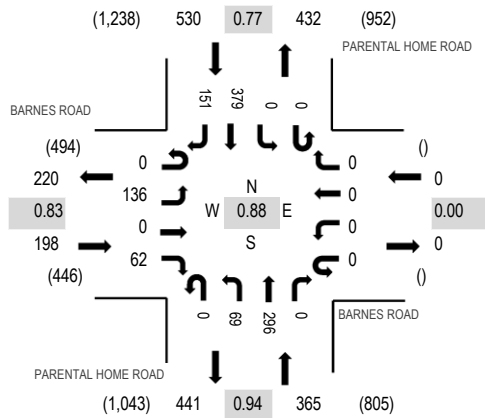

Peak Hour - Pedestrians/Bicycles in Crosswalk

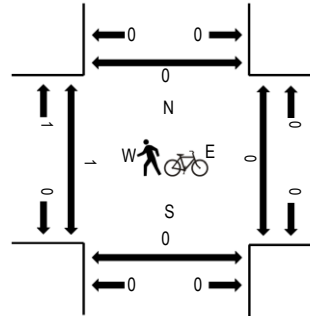

Note: Total study counts contained in parentheses.

Traffic Counts - Motorized Vehicles

Interval Start Time	BARNES ROAD Eastbound				BARNES ROAD Westbound				PARENTAL HOME ROAD Northbound				PARENTAL HOME ROAD Southbound				Total	Rolling Hour	Pedestrian Crossings			
	U-Turn	Left	Thru	Right	U-Turn	Left	Thru	Right	U-Turn	Left	Thru	Right	U-Turn	Left	Thru	Right			West	East	South	North
6:00 AM	0	10	0	7	0	0	0	0	0	1	28	0	0	0	24	15	85	564	0	0	0	0
6:15 AM	0	25	0	3	0	0	0	0	0	1	33	0	0	0	54	23	139	662	1	0	0	0
6:30 AM	0	30	0	8	0	0	0	0	0	5	30	0	0	0	62	18	153	777	0	1	0	0
6:45 AM	0	19	0	6	0	0	0	0	0	10	54	0	0	0	64	34	187	933	0	0	0	0
7:00 AM	0	18	0	16	0	0	0	0	0	6	40	0	0	0	75	28	183	1,024	0	0	0	0
7:15 AM	0	30	0	13	0	0	0	0	0	12	78	0	0	0	88	33	254	1,093	1	0	0	0
7:30 AM	0	41	0	10	0	0	0	0	0	19	67	0	0	0	108	64	309	1,052	0	0	0	0
7:45 AM	0	29	0	15	0	0	0	0	0	19	78	0	0	0	103	34	278	966	0	0	0	0
8:00 AM	0	36	0	24	0	0	0	0	0	19	73	0	0	0	80	20	252	901	0	0	0	0
8:15 AM	0	18	0	17	0	0	0	0	0	19	56	0	0	0	77	26	213		0	1	0	0
8:30 AM	0	15	0	20	0	0	0	0	0	19	60	0	0	0	90	19	223		0	1	0	0
8:45 AM	0	21	0	15	0	0	0	0	0	15	63	0	0	0	64	35	213		1	0	0	0

Peak Rolling Hour Flow Rates

Vehicle Type	Eastbound				Westbound				Northbound				Southbound				Total
	U-Turn	Left	Thru	Right	U-Turn	Left	Thru	Right	U-Turn	Left	Thru	Right	U-Turn	Left	Thru	Right	
Articulated Trucks	0	0	0	0	0	0	0	0	0	0	2	0	0	0	1	0	3
Lights	0	129	0	59	0	0	0	0	0	67	282	0	0	0	370	150	1,057
Mediums	0	7	0	3	0	0	0	0	0	2	12	0	0	0	8	1	33
Total	0	136	0	62	0	0	0	0	0	69	296	0	0	0	379	151	1,093

Location: 3 PARENTAL HOME ROAD & DEAN ROAD AM

Date: Tuesday, September 15, 2020

Peak Hour: 07:15 AM - 08:15 AM

Peak 15-Minutes: 07:30 AM - 07:45 AM

Peak Hour - Motorized Vehicles

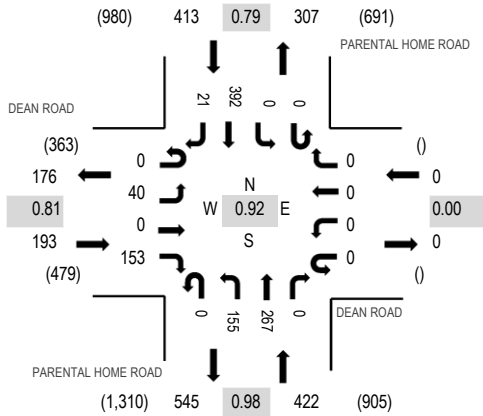

Peak Hour - Pedestrians/Bicycles in Crosswalk

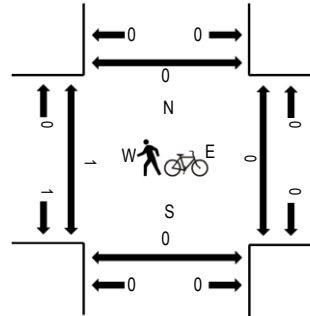

Note: Total study counts contained in parentheses.

Traffic Counts - Motorized Vehicles

Interval Start Time	DEAN ROAD Eastbound				DEAN ROAD Westbound				PARENTAL HOME ROAD Northbound				PARENTAL HOME ROAD Southbound				Total	Rolling Hour	Pedestrian Crossings					
	U-Turn	Left	Thru	Right	U-Turn	Left	Thru	Right	U-Turn	Left	Thru	Right	U-Turn	Left	Thru	Right			West	East	South	North		
6:00 AM	0	4	0	15	0	0	0	0	0	0	9	27	0	0	0	0	30	4	89	568	1	0	0	0
6:15 AM	0	8	0	21	0	0	0	0	0	0	6	43	0	0	0	0	69	6	153	655	0	0	0	0
6:30 AM	0	7	0	30	0	0	0	0	0	0	13	44	0	0	0	0	61	0	155	749	0	0	0	0
6:45 AM	0	0	0	26	0	0	0	0	0	0	28	37	0	0	0	0	76	4	171	873	0	0	0	0
7:00 AM	0	3	0	37	0	0	0	0	0	0	15	40	0	0	0	0	76	5	176	970	2	0	0	0
7:15 AM	0	12	0	38	0	0	0	0	0	0	33	75	0	0	0	0	87	2	247	1,028	0	0	0	0
7:30 AM	0	8	0	38	0	0	0	0	0	0	36	67	0	0	0	0	125	5	279	962	0	0	0	0
7:45 AM	0	15	0	38	0	0	0	0	0	0	43	64	0	0	0	0	98	10	268	882	0	0	0	0
8:00 AM	0	5	0	39	0	0	0	0	0	0	43	61	0	0	0	0	82	4	234	826	1	0	0	0
8:15 AM	0	3	0	35	0	0	0	0	0	0	20	52	0	0	0	0	61	10	181		2	0	0	0
8:30 AM	0	12	0	48	0	0	0	0	0	0	26	41	0	0	0	0	67	5	199		1	0	0	0
8:45 AM	0	7	0	30	0	0	0	0	0	0	26	56	0	0	0	0	83	10	212		3	0	0	0

Peak Rolling Hour Flow Rates

Vehicle Type	Eastbound				Westbound				Northbound				Southbound				Total	
	U-Turn	Left	Thru	Right	U-Turn	Left	Thru	Right	U-Turn	Left	Thru	Right	U-Turn	Left	Thru	Right		
Articulated Trucks	0	0	0	0	0	0	0	0	0	1	1	0	0	0	0	1	0	3
Lights	0	39	0	150	0	0	0	0	0	150	251	0	0	0	0	389	21	1,000
Mediums	0	1	0	3	0	0	0	0	0	4	15	0	0	0	0	2	0	25
Total	0	40	0	153	0	0	0	0	0	155	267	0	0	0	0	392	21	1,028

Location: 4 PARENTAL HOME ROAD & HOGAN ROAD AM

Date: Tuesday, September 15, 2020

Peak Hour: 07:15 AM - 08:15 AM

Peak 15-Minutes: 07:45 AM - 08:00 AM

Peak Hour - Motorized Vehicles

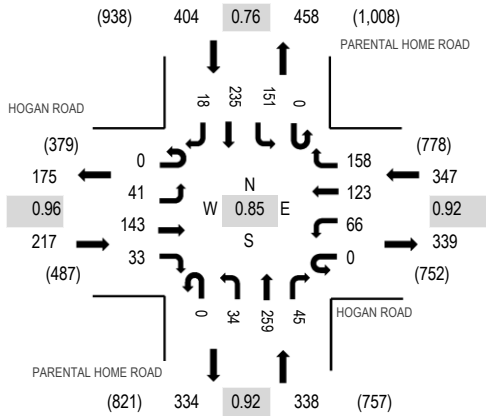

Peak Hour - Pedestrians/Bicycles in Crosswalk

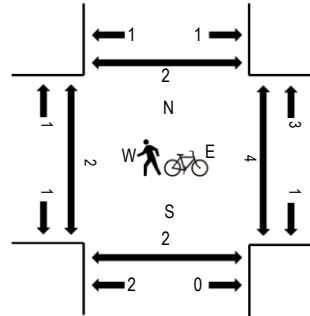

Note: Total study counts contained in parentheses.

Traffic Counts - Motorized Vehicles

Interval Start Time	HOGAN ROAD Eastbound				HOGAN ROAD Westbound				PARENTAL HOME ROAD Northbound				PARENTAL HOME ROAD Southbound				Total	Rolling Hour	Pedestrian Crossings			
	U-Turn	Left	Thru	Right	U-Turn	Left	Thru	Right	U-Turn	Left	Thru	Right	U-Turn	Left	Thru	Right			West	East	South	North
6:00 AM	0	1	11	2	0	3	7	10	0	0	34	1	0	9	25	3	106	695	0	0	0	0
6:15 AM	0	4	16	6	0	9	13	15	0	5	50	3	0	14	48	1	184	788	0	0	0	0
6:30 AM	0	7	20	6	0	5	16	29	0	6	43	14	0	19	35	1	201	881	0	0	0	0
6:45 AM	0	2	22	4	0	10	17	25	0	2	37	6	0	24	53	2	204	1,029	0	0	0	0
7:00 AM	0	1	17	6	0	10	26	37	0	2	36	5	0	14	43	2	199	1,208	0	0	0	0
7:15 AM	0	9	27	1	0	15	31	42	0	5	68	7	0	22	47	3	277	1,306	0	1	0	0
7:30 AM	0	12	37	12	0	16	24	55	0	11	68	13	0	33	65	3	349	1,296	0	0	2	0
7:45 AM	0	12	38	13	0	18	39	35	0	5	72	14	0	59	70	8	383	1,181	0	3	0	0
8:00 AM	0	8	41	7	0	17	29	26	0	13	51	11	0	37	53	4	297	1,057	1	0	0	1
8:15 AM	0	8	44	9	0	10	32	22	0	2	41	16	0	25	52	6	267		0	0	3	0
8:30 AM	0	5	33	5	0	16	20	29	0	2	46	10	0	18	44	6	234		0	0	1	0
8:45 AM	0	4	33	4	0	19	28	23	0	4	41	13	0	26	63	1	259		0	0	0	0

Peak Rolling Hour Flow Rates

Vehicle Type	Eastbound				Westbound				Northbound				Southbound				Total
	U-Turn	Left	Thru	Right	U-Turn	Left	Thru	Right	U-Turn	Left	Thru	Right	U-Turn	Left	Thru	Right	
Articulated Trucks	0	1	0	1	0	0	0	1	0	0	0	1	0	1	0	0	5
Lights	0	37	137	32	0	66	120	155	0	34	249	41	0	150	234	18	1,273
Mediums	0	3	6	0	0	0	3	2	0	0	10	3	0	0	1	0	28
Total	0	41	143	33	0	66	123	158	0	34	259	45	0	151	235	18	1,306



ALL TRAFFIC DATA SERVICES

(303) 216-2439

www.alltrafficdata.net

Location: 1 PARENTAL HOME ROAD & BOWDEN ROAD Noon

Date: Tuesday, September 15, 2020

Peak Hour: 11:45 AM - 12:45 PM

Peak 15-Minutes: 12:00 PM - 12:15 PM

Peak Hour - Motorized Vehicles

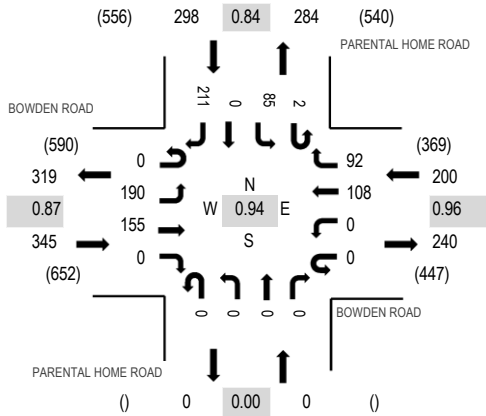

Peak Hour - Pedestrians/Bicycles in Crosswalk

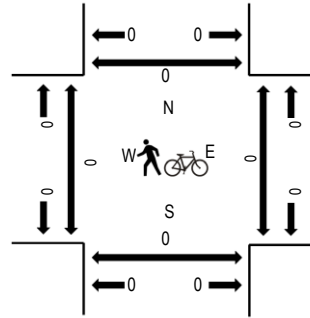

Note: Total study counts contained in parentheses.

Traffic Counts - Motorized Vehicles

Interval Start Time	BOWDEN ROAD Eastbound				BOWDEN ROAD Westbound				PARENTAL HOME ROAD Northbound				PARENTAL HOME ROAD Southbound				Total	Rolling Hour	Pedestrian Crossings			
	U-Turn	Left	Thru	Right	U-Turn	Left	Thru	Right	U-Turn	Left	Thru	Right	U-Turn	Left	Thru	Right			West	East	South	North
	11:00 AM	0	35	27	0	0	0	26	16	0	0	0	0	1	17	0			36	158	749	0
11:15 AM	0	47	31	0	0	0	26	14	0	0	0	0	1	22	0	40	181	816	0	0	0	0
11:30 AM	0	56	33	0	0	0	23	20	0	0	0	0	0	25	0	43	200	830	0	0	2	0
11:45 AM	0	46	36	0	0	0	27	25	0	0	0	0	1	23	0	52	210	843	0	0	0	0
12:00 PM	0	54	34	0	0	0	20	27	0	0	0	0	1	22	0	67	225	828	0	0	0	0
12:15 PM	0	42	34	0	0	0	30	19	0	0	0	0	0	21	0	49	195		0	0	0	0
12:30 PM	0	48	51	0	0	0	31	21	0	0	0	0	0	19	0	43	213		0	0	0	0
12:45 PM	0	48	30	0	0	0	26	18	0	0	0	0	0	22	0	51	195		0	0	0	0

Peak Rolling Hour Flow Rates

Vehicle Type	Eastbound				Westbound				Northbound				Southbound				Total
	U-Turn	Left	Thru	Right	U-Turn	Left	Thru	Right	U-Turn	Left	Thru	Right	U-Turn	Left	Thru	Right	
Articulated Trucks	0	2	0	0	0	0	0	2	0	0	0	0	0	1	0	3	8
Lights	0	186	151	0	0	0	107	89	0	0	0	0	2	83	0	202	820
Mediums	0	2	4	0	0	0	1	1	0	0	0	0	0	1	0	6	15
Total	0	190	155	0	0	0	108	92	0	0	0	0	2	85	0	211	843



ALL TRAFFIC DATA SERVICES

(303) 216-2439

www.alltrafficdata.net

Location: 2 PARENTAL HOME ROAD & BARNES ROAD Noon

Date: Tuesday, September 15, 2020

Peak Hour: 11:30 AM - 12:30 PM

Peak 15-Minutes: 12:00 PM - 12:15 PM

Peak Hour - Motorized Vehicles

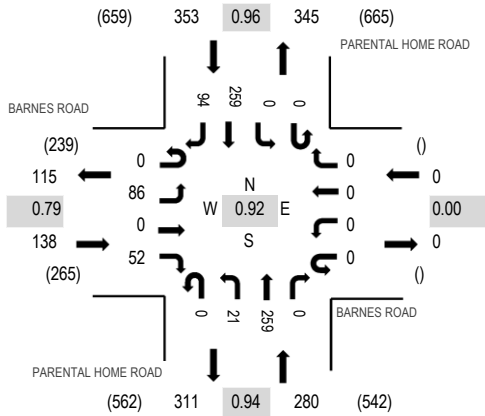

Peak Hour - Pedestrians/Bicycles in Crosswalk

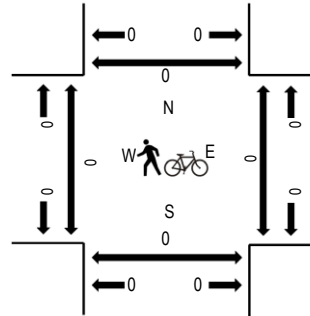

Note: Total study counts contained in parentheses.

Traffic Counts - Motorized Vehicles

Interval Start Time	BARNES ROAD Eastbound				BARNES ROAD Westbound				PARENTAL HOME ROAD Northbound				PARENTAL HOME ROAD Southbound				Total	Rolling Hour	Pedestrian Crossings					
	U-Turn	Left	Thru	Right	U-Turn	Left	Thru	Right	U-Turn	Left	Thru	Right	U-Turn	Left	Thru	Right			West	East	South	North		
	11:00 AM	0	19	0	8	0	0	0	0	0	0	7	48	0	0	0			0	47	28	157	710	0
11:15 AM	0	28	0	10	0	0	0	0	0	0	2	60	0	0	0	0	46	22	168	763	0	0	0	0
11:30 AM	0	21	0	14	0	0	0	0	0	0	6	66	0	0	0	0	65	27	199	771	0	0	0	0
11:45 AM	0	15	0	14	0	0	0	0	0	0	7	65	0	0	0	0	61	24	186	751	0	0	0	0
12:00 PM	0	32	0	15	0	0	0	0	0	0	6	69	0	0	0	0	71	17	210	756	0	0	0	0
12:15 PM	0	18	0	9	0	0	0	0	0	0	2	59	0	0	0	0	62	26	176		0	0	0	0
12:30 PM	0	22	0	10	0	0	0	0	0	0	12	61	0	0	0	0	55	19	179		0	0	0	0
12:45 PM	0	23	0	7	0	0	0	0	0	0	13	59	0	0	0	0	68	21	191		0	0	0	0

Peak Rolling Hour Flow Rates

Vehicle Type	Eastbound				Westbound				Northbound				Southbound				Total	
	U-Turn	Left	Thru	Right	U-Turn	Left	Thru	Right	U-Turn	Left	Thru	Right	U-Turn	Left	Thru	Right		
Articulated Trucks	0	1	0	0	0	0	0	0	0	0	5	0	0	0	0	3	1	10
Lights	0	81	0	49	0	0	0	0	0	20	250	0	0	0	251	91	742	
Mediums	0	4	0	3	0	0	0	0	0	1	4	0	0	0	5	2	19	
Total	0	86	0	52	0	0	0	0	0	21	259	0	0	0	259	94	771	



ALL TRAFFIC DATA SERVICES

(303) 216-2439

www.alltrafficdata.net

Location: 3 PARENTAL HOME ROAD & DEAN ROAD Noon

Date: Tuesday, September 15, 2020

Peak Hour: 11:45 AM - 12:45 PM

Peak 15-Minutes: 12:00 PM - 12:15 PM

Peak Hour - Motorized Vehicles

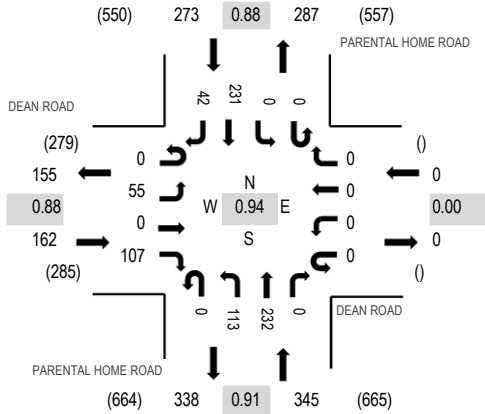

Peak Hour - Pedestrians/Bicycles in Crosswalk

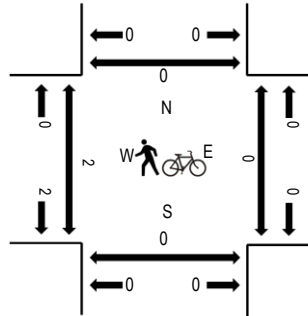

Note: Total study counts contained in parentheses.

Traffic Counts - Motorized Vehicles

Interval Start Time	DEAN ROAD Eastbound				DEAN ROAD Westbound				PARENTAL HOME ROAD Northbound			PARENTAL HOME ROAD Southbound				Total	Rolling Hour	Pedestrian Crossings				
	U-Turn	Left	Thru	Right	U-Turn	Left	Thru	Right	U-Turn	Left	Thru	Right	U-Turn	Left	Thru			Right	West	East	South	North
11:00 AM	0	10	0	19	0	0	0	0	0	21	47	0	0	0	52	10	159	726	1	0	0	0
11:15 AM	0	11	0	23	0	0	0	0	0	25	60	0	0	0	55	11	185	775	1	0	0	0
11:30 AM	0	7	0	25	0	0	0	0	0	20	66	0	0	0	58	11	187	776	0	0	0	0
11:45 AM	0	13	0	24	0	0	0	0	0	26	59	0	0	0	62	11	195	780	0	0	0	0
12:00 PM	0	9	0	33	0	0	0	0	0	28	69	0	0	0	57	12	208	774	0	0	0	0
12:15 PM	0	20	0	26	0	0	0	0	0	27	50	0	0	0	58	5	186		2	0	0	0
12:30 PM	0	13	0	24	0	0	0	0	0	32	54	0	0	0	54	14	191		0	0	0	0
12:45 PM	0	7	0	21	0	0	0	0	0	19	62	0	0	0	73	7	189		0	0	0	0

Peak Rolling Hour Flow Rates

Vehicle Type	Eastbound				Westbound				Northbound				Southbound				Total
	U-Turn	Left	Thru	Right	U-Turn	Left	Thru	Right	U-Turn	Left	Thru	Right	U-Turn	Left	Thru	Right	
Articulated Trucks	0	0	0	0	0	0	0	0	0	1	3	0	0	0	4	1	9
Lights	0	55	0	107	0	0	0	0	0	107	225	0	0	0	219	41	754
Mediums	0	0	0	0	0	0	0	0	0	5	4	0	0	0	8	0	17
Total	0	55	0	107	0	0	0	0	0	113	232	0	0	0	231	42	780

Peak Hour - Motorized Vehicles

Peak Hour - Pedestrians/Bicycles in Crosswalk

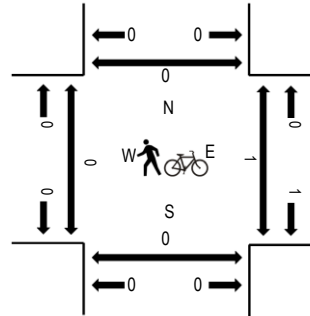
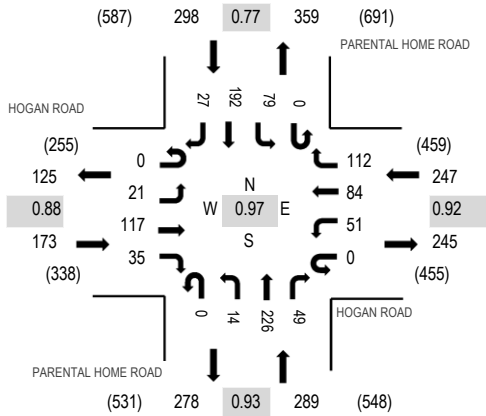

Note: Total study counts contained in parentheses.

Traffic Counts - Motorized Vehicles

Interval Start Time	HOGAN ROAD Eastbound				HOGAN ROAD Westbound				PARENTAL HOME ROAD Northbound				PARENTAL HOME ROAD Southbound				Total	Rolling Hour	Pedestrian Crossings			
	U-Turn	Left	Thru	Right	U-Turn	Left	Thru	Right	U-Turn	Left	Thru	Right	U-Turn	Left	Thru	Right			West	East	South	North
11:00 AM	0	7	25	6	0	9	21	25	0	7	42	3	0	15	46	12	218	925	0	0	0	0
11:15 AM	0	12	25	4	0	14	16	17	0	3	60	14	0	21	45	6	237	962	0	0	0	0
11:30 AM	0	13	34	3	0	9	13	26	0	5	51	7	0	14	52	6	233	967	0	0	0	0
11:45 AM	0	7	22	7	0	17	24	21	0	7	51	9	0	21	41	10	237	994	0	0	0	1
12:00 PM	0	4	32	7	0	11	18	33	0	2	65	11	0	19	46	7	255	1,007	0	0	0	0
12:15 PM	0	6	29	12	0	10	22	31	0	4	53	14	0	19	38	4	242		0	0	0	0
12:30 PM	0	7	31	10	0	16	26	28	0	4	55	15	0	15	47	6	260		0	0	0	0
12:45 PM	0	4	25	6	0	14	18	20	0	4	53	9	0	26	61	10	250		0	0	0	0

Peak Rolling Hour Flow Rates

Vehicle Type	Eastbound				Westbound				Northbound				Southbound				Total
	U-Turn	Left	Thru	Right	U-Turn	Left	Thru	Right	U-Turn	Left	Thru	Right	U-Turn	Left	Thru	Right	
Articulated Trucks	0	0	1	1	0	0	1	0	0	0	4	0	0	1	2	0	10
Lights	0	21	116	33	0	50	83	109	0	14	220	48	0	74	187	27	982
Mediums	0	0	0	1	0	1	0	3	0	0	2	1	0	4	3	0	15
Total	0	21	117	35	0	51	84	112	0	14	226	49	0	79	192	27	1,007

Location: 2 PARENTAL HOME ROAD & BARNES ROAD PM

Date: Tuesday, September 15, 2020

Peak Hour: 05:00 PM - 06:00 PM

Peak 15-Minutes: 05:30 PM - 05:45 PM

Peak Hour - Motorized Vehicles

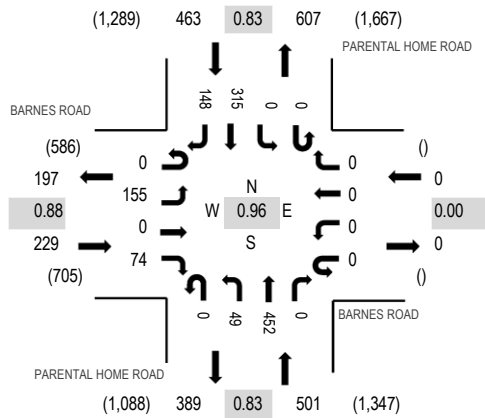

Peak Hour - Pedestrians/Bicycles in Crosswalk

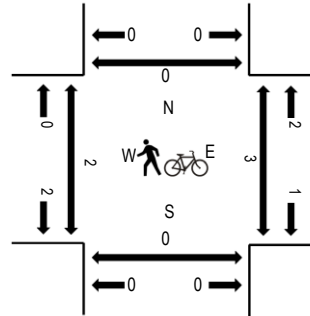

Note: Total study counts contained in parentheses.

Traffic Counts - Motorized Vehicles

Interval Start Time	BARNES ROAD Eastbound				BARNES ROAD Westbound				PARENTAL HOME ROAD Northbound				PARENTAL HOME ROAD Southbound				Total	Rolling Hour	Pedestrian Crossings			
	U-Turn	Left	Thru	Right	U-Turn	Left	Thru	Right	U-Turn	Left	Thru	Right	U-Turn	Left	Thru	Right			West	East	South	North
3:00 PM	0	47	0	25	0	0	0	0	0	14	69	0	0	0	69	32	256	1,037	0	1	0	0
3:15 PM	0	39	0	21	0	0	0	0	0	9	79	0	0	0	50	26	224	1,045	0	0	0	0
3:30 PM	0	41	0	18	0	0	0	0	0	14	92	0	0	0	78	43	286	1,080	0	0	0	0
3:45 PM	0	37	0	15	0	0	0	0	0	18	94	0	0	0	61	46	271	1,109	1	0	0	0
4:00 PM	0	28	0	14	0	0	0	0	0	9	110	0	0	0	68	35	264	1,111	1	0	0	0
4:15 PM	0	45	0	15	0	0	0	0	0	18	91	0	0	0	63	27	259	1,156	3	1	1	0
4:30 PM	0	46	0	26	0	0	0	0	0	12	117	0	0	0	82	32	315	1,181	0	0	0	0
4:45 PM	0	41	0	18	0	0	0	0	0	16	84	0	0	0	76	38	273	1,176	0	0	0	0
5:00 PM	0	47	0	12	0	0	0	0	0	7	145	0	0	0	64	34	309	1,193	0	1	0	0
5:15 PM	0	48	0	15	0	0	0	0	0	20	103	0	0	0	70	28	284		0	1	0	0
5:30 PM	0	36	0	28	0	0	0	0	0	11	96	0	0	0	95	44	310		0	0	0	0
5:45 PM	0	24	0	19	0	0	0	0	0	11	108	0	0	0	86	42	290		2	1	0	0

Peak Rolling Hour Flow Rates

Vehicle Type	Eastbound				Westbound				Northbound				Southbound				Total
	U-Turn	Left	Thru	Right	U-Turn	Left	Thru	Right	U-Turn	Left	Thru	Right	U-Turn	Left	Thru	Right	
Articulated Trucks	0	1	0	0	0	0	0	0	0	0	0	0	0	0	1	0	2
Lights	0	153	0	74	0	0	0	0	0	48	445	0	0	0	304	145	1,169
Mediums	0	1	0	0	0	0	0	0	0	1	7	0	0	0	10	3	22
Total	0	155	0	74	0	0	0	0	0	49	452	0	0	0	315	148	1,193



(303) 216-2439
www.alltrafficdata.net

Location: 3 PARENTAL HOME ROAD & DEAN ROAD PM

Date: Tuesday, September 15, 2020

Peak Hour: 05:00 PM - 06:00 PM

Peak 15-Minutes: 05:00 PM - 05:15 PM

Peak Hour - Motorized Vehicles

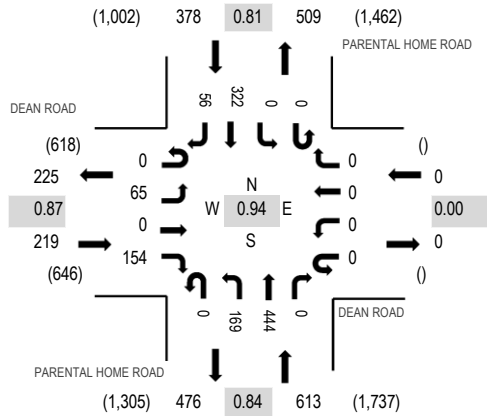

Peak Hour - Pedestrians/Bicycles in Crosswalk

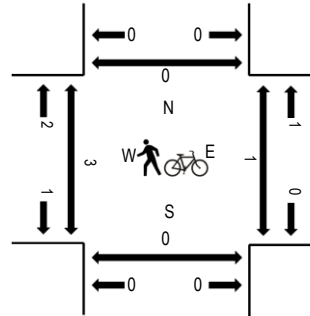

Note: Total study counts contained in parentheses.

Traffic Counts - Motorized Vehicles

Interval Start Time	DEAN ROAD Eastbound				DEAN ROAD Westbound				PARENTAL HOME ROAD Northbound			PARENTAL HOME ROAD Southbound				Total	Rolling Hour	Pedestrian Crossings					
	U-Turn	Left	Thru	Right	U-Turn	Left	Thru	Right	U-Turn	Left	Thru	Right	U-Turn	Left	Thru			Right	West	East	South	North	
3:00 PM	0	28	0	37	0	0	0	0	0	29	93	0	0	0	0	57	11	255	1,056	0	0	0	0
3:15 PM	0	20	0	28	0	0	0	0	0	35	92	0	0	0	0	59	8	242	1,073	0	0	0	0
3:30 PM	0	13	0	50	0	0	0	0	0	36	110	0	0	0	0	60	14	283	1,104	0	0	0	0
3:45 PM	0	11	0	38	0	0	0	0	0	43	97	0	0	0	0	75	12	276	1,138	2	0	0	0
4:00 PM	0	13	0	38	0	0	0	0	0	40	100	0	0	0	0	71	10	272	1,119	0	0	0	0
4:15 PM	0	11	0	33	0	0	0	0	0	39	113	0	0	0	0	63	14	273	1,170	0	0	0	0
4:30 PM	0	26	0	35	0	0	0	0	0	55	113	0	0	0	0	78	10	317	1,196	0	0	0	0
4:45 PM	0	11	0	35	0	0	0	0	0	27	102	0	0	0	0	72	10	257	1,186	2	0	0	0
5:00 PM	0	15	0	39	0	0	0	0	0	49	145	0	0	0	0	60	15	323	1,210	2	0	0	0
5:15 PM	0	22	0	32	0	0	0	0	0	47	110	0	0	0	0	76	12	299		0	0	0	0
5:30 PM	0	12	0	46	0	0	0	0	0	34	98	0	0	0	0	105	12	307		0	1	0	0
5:45 PM	0	16	0	37	0	0	0	0	0	39	91	0	0	0	0	81	17	281		0	0	0	0

Peak Rolling Hour Flow Rates

Vehicle Type	Eastbound				Westbound				Northbound				Southbound				Total
	U-Turn	Left	Thru	Right	U-Turn	Left	Thru	Right	U-Turn	Left	Thru	Right	U-Turn	Left	Thru	Right	
Articulated Trucks	0	0	0	0	0	0	0	0	0	0	0	0	0	0	2	0	2
Lights	0	65	0	150	0	0	0	0	0	167	440	0	0	0	309	56	1,187
Mediums	0	0	0	4	0	0	0	0	0	2	4	0	0	0	11	0	21
Total	0	65	0	154	0	0	0	0	0	169	444	0	0	0	322	56	1,210

Location: 4 PARENTAL HOME ROAD & HOGAN ROAD PM

Date: Tuesday, September 15, 2020

Peak Hour: 04:15 PM - 05:15 PM

Peak 15-Minutes: 04:30 PM - 04:45 PM

Peak Hour - Motorized Vehicles

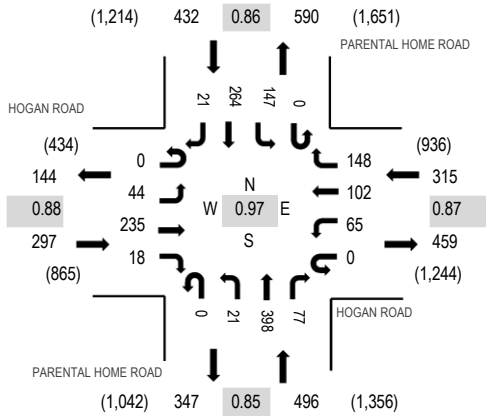

Peak Hour - Pedestrians/Bicycles in Crosswalk

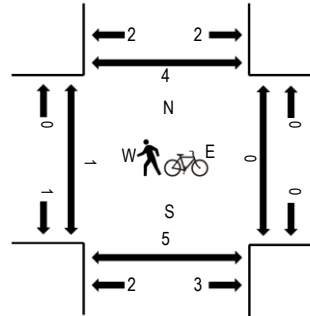

Note: Total study counts contained in parentheses.

Traffic Counts - Motorized Vehicles

Interval Start Time	HOGAN ROAD Eastbound			HOGAN ROAD Westbound			PARENTAL HOME ROAD Northbound			PARENTAL HOME ROAD Southbound			Total	Rolling Hour	Pedestrian Crossings				
	U-Turn	Left	Thru Right	U-Turn	Left	Thru Right	U-Turn	Left	Thru Right	U-Turn	Left	Thru Right			West	East	South	North	
3:00 PM	0	15	65 14	0	10	16 26	0	8	83 29	0	35	54	6	361	1,396	0	0	3	2
3:15 PM	0	12	46 4	0	15	24 45	0	5	82 18	0	27	53	3	334	1,366	1	0	0	0
3:30 PM	0	6	51 7	0	23	19 48	0	4	98 15	0	37	46	7	361	1,408	0	0	0	4
3:45 PM	0	8	47 14	0	12	20 28	0	7	81 13	0	29	75	6	340	1,444	0	0	0	0
4:00 PM	0	13	52 11	0	12	29 32	0	3	78 16	0	25	53	7	331	1,477	2	0	0	0
4:15 PM	0	15	68 5	0	15	25 38	0	5	92 20	0	32	58	3	376	1,540	1	0	0	0
4:30 PM	0	12	59 4	0	15	20 37	0	2	100 25	0	36	77	10	397	1,528	0	0	3	3
4:45 PM	0	11	42 4	0	17	35 34	0	5	90 10	0	44	77	4	373	1,529	0	0	0	0
5:00 PM	0	6	66 5	0	18	22 39	0	9	116 22	0	35	52	4	394	1,498	0	0	0	0
5:15 PM	0	10	54 8	0	15	27 37	0	6	94 20	0	24	67	2	364		0	1	0	0
5:30 PM	0	12	52 9	0	21	38 40	0	4	85 11	0	36	78	12	398		0	0	0	0
5:45 PM	0	6	40 12	0	16	28 40	0	4	82 14	0	29	66	5	342		1	0	0	0

Peak Rolling Hour Flow Rates

Vehicle Type	Eastbound				Westbound				Northbound				Southbound				Total
	U-Turn	Left	Thru	Right	U-Turn	Left	Thru	Right	U-Turn	Left	Thru	Right	U-Turn	Left	Thru	Right	
Articulated Trucks	0	0	1	0	0	0	0	0	0	0	0	0	0	0	1	0	2
Lights	0	42	234	18	0	65	98	148	0	21	389	77	0	146	257	20	1,515
Mediums	0	2	0	0	0	0	4	0	0	0	9	0	0	1	6	1	23
Total	0	44	235	18	0	65	102	148	0	21	398	77	0	147	264	21	1,540

Appendix B

FDOT TRENDS Worksheets

Traffic Trends - V03.a PARENTAL HOME ROAD --

FIN#	1234
Location	1

County:	Duval (72)
Station #:	9018
Highway:	PARENTAL HOME ROAD

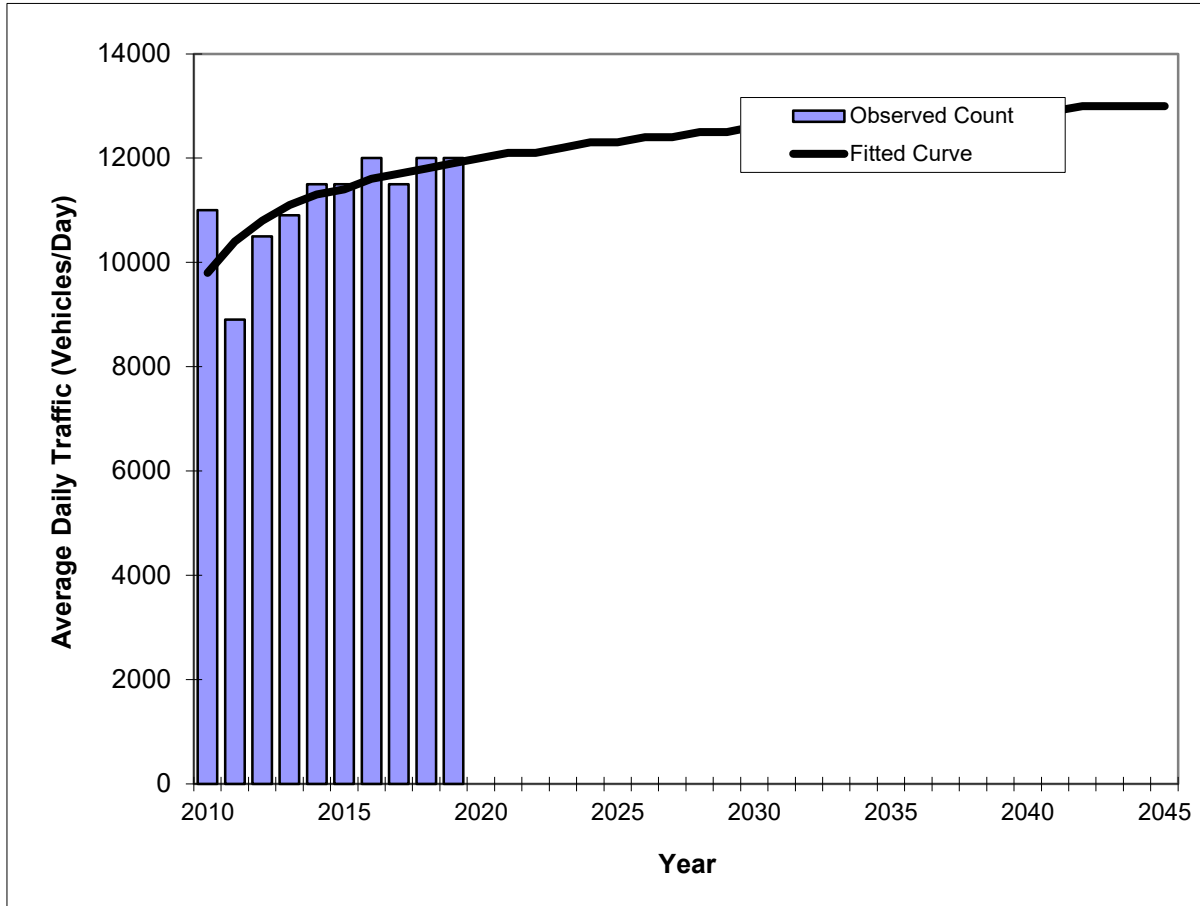

Year	Traffic (ADT/AADT)	
	Count*	Trend**
2010	11000	9800
2011	8900	10400
2012	10500	10800
2013	10900	11100
2014	11500	11300
2015	11500	11400
2016	12000	11600
2017	11500	11700
2018	12000	11800
2019	12000	11900
2025 Opening Year Trend		
2025	N/A	12300
2035 Mid-Year Trend		
2035	N/A	12700
2045 Design Year Trend		
2045	N/A	13000
TRANPLAN Forecasts/Trends		

Trend R-squared:	47.75%
Compounded Annual Historic Growth Rate:	2.18%
Compounded Growth Rate (2019 to Design Year):	0.34%
Printed:	29-Oct-20
Decaying Exponential Growth Option	

*Axle-Adjusted

Traffic Trends - V03.a PARENTAL HOME ROAD --

FIN#	1234
Location	1

County:	Duval (72)
Station #:	9018
Highway:	PARENTAL HOME ROAD

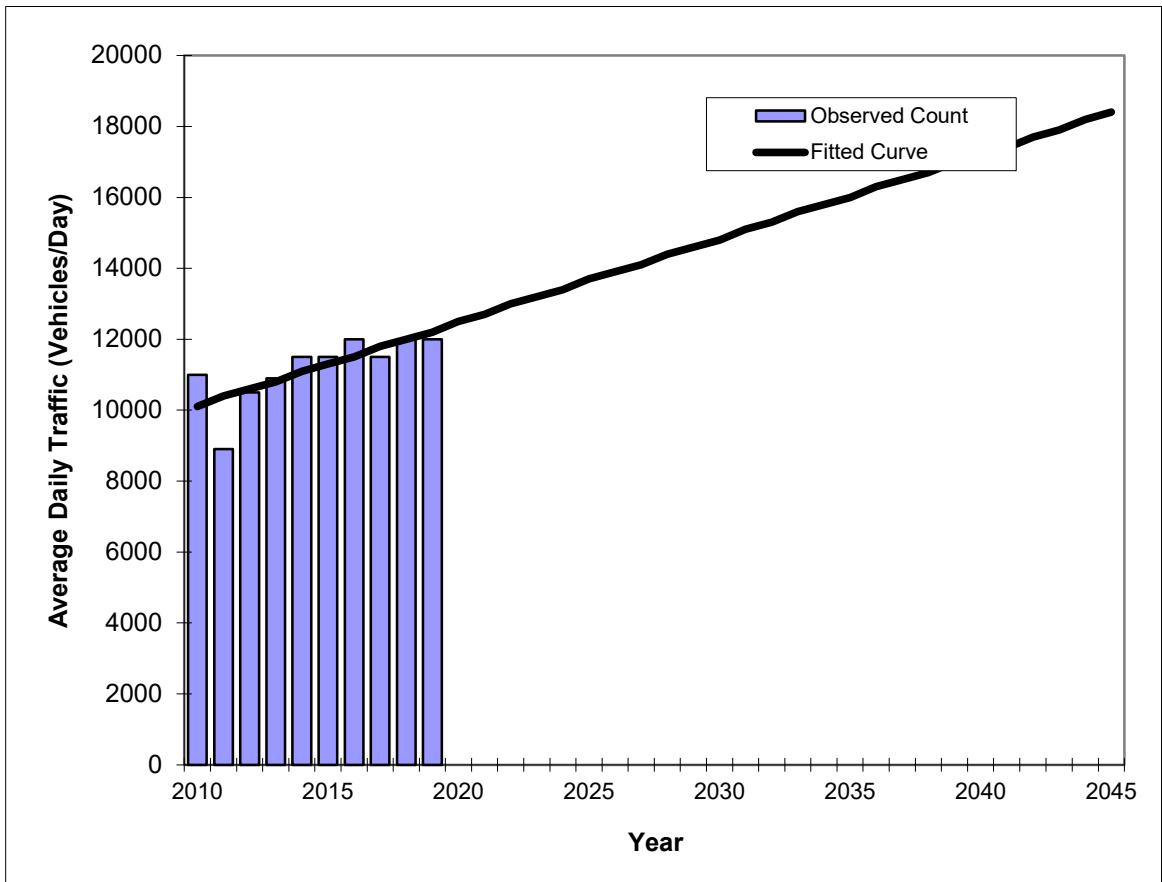

Year	Traffic (ADT/AADT)	
	Count*	Trend**
2010	11000	10100
2011	8900	10400
2012	10500	10600
2013	10900	10800
2014	11500	11100
2015	11500	11300
2016	12000	11500
2017	11500	11800
2018	12000	12000
2019	12000	12200
2025 Opening Year Trend		
2025	N/A	13700
2035 Mid-Year Trend		
2035	N/A	16000
2045 Design Year Trend		
2045	N/A	18400
TRANPLAN Forecasts/Trends		

** Annual Trend Increase:	236
Trend R-squared:	56.93%
Trend Annual Historic Growth Rate:	2.31%
Trend Growth Rate (2019 to Design Year):	1.95%
Printed:	29-Oct-20

Straight Line Growth Option

*Axle-Adjusted

Traffic Trends - V03.a PARENTAL HOME ROAD --

FIN#	1234
Location	2

County:	Duval (72)
Station #:	9229
Highway:	PARENTAL HOME ROAD

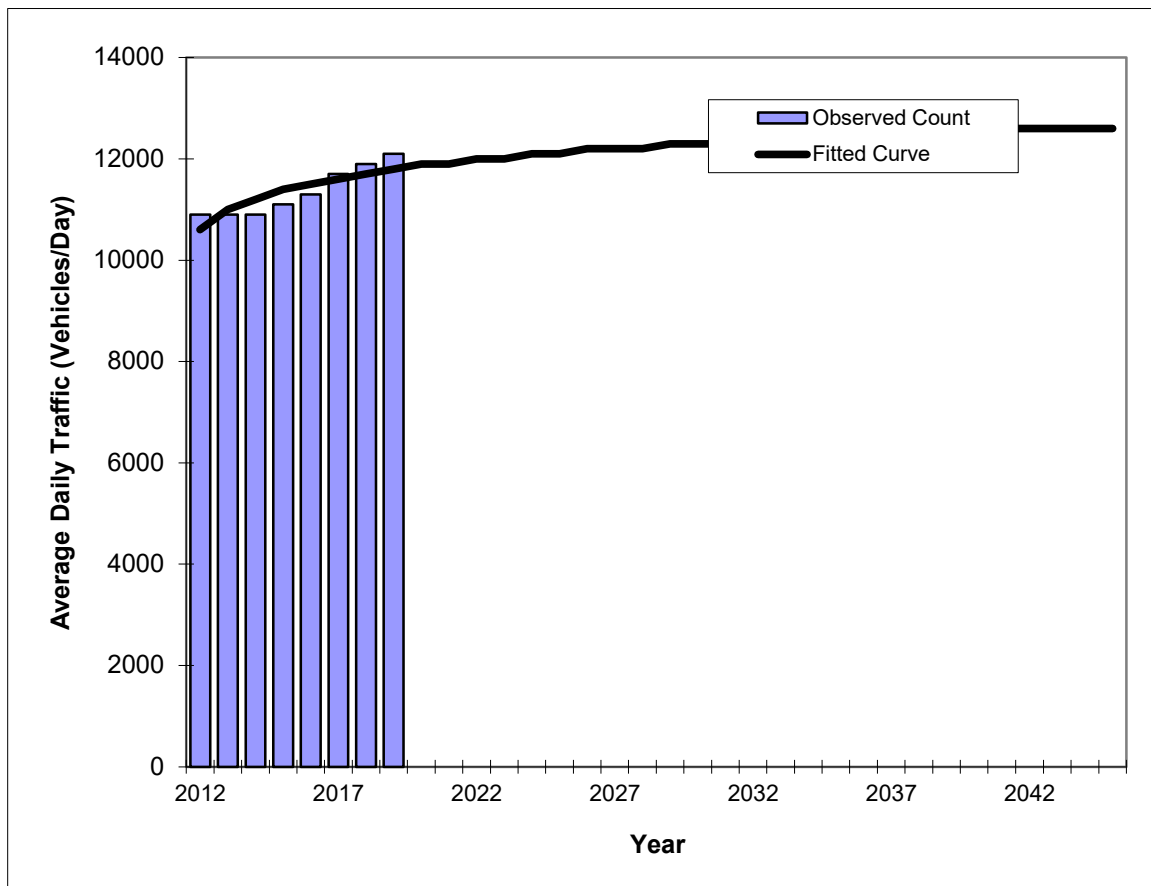

Year	Traffic (ADT/AADT)	
	Count*	Trend**
2012	10900	10600
2013	10900	11000
2014	10900	11200
2015	11100	11400
2016	11300	11500
2017	11700	11600
2018	11900	11700
2019	12100	11800
2025 Opening Year Trend		
2025	N/A	12100
2035 Mid-Year Trend		
2035	N/A	12400
2045 Design Year Trend		
2045	N/A	12600
TRANPLAN Forecasts/Trends		

Trend R-squared:	71.23%
Compounded Annual Historic Growth Rate:	1.54%
Compounded Growth Rate (2019 to Design Year):	0.25%
Printed:	29-Oct-20
Decaying Exponential Growth Option	

*Axle-Adjusted

Traffic Trends - V03.a PARENTAL HOME ROAD --

FIN#	1234
Location	2

County:	Duval (72)
Station #:	9229
Highway:	PARENTAL HOME ROAD

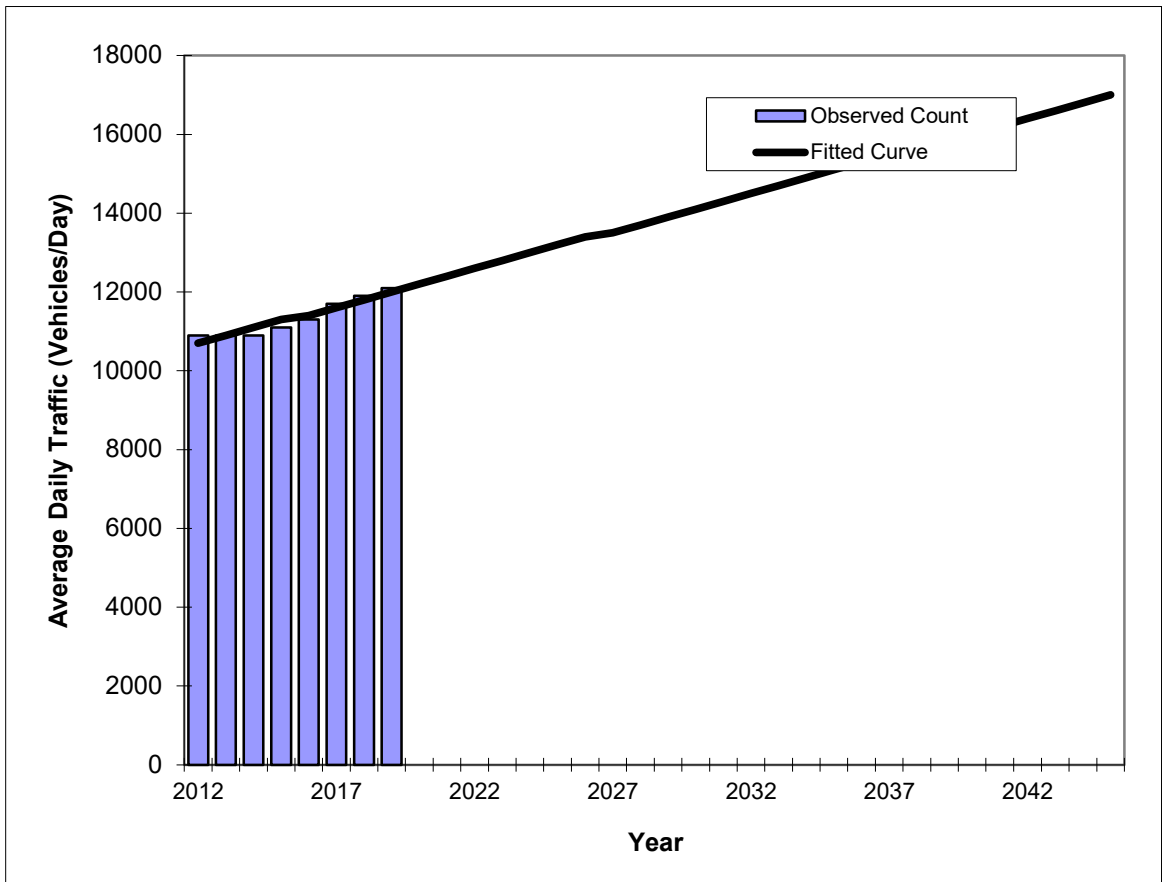

Year	Traffic (ADT/AADT)	
	Count*	Trend**
2012	10900	10700
2013	10900	10900
2014	10900	11100
2015	11100	11300
2016	11300	11400
2017	11700	11600
2018	11900	11800
2019	12100	12000
2025 Opening Year Trend		
2025	N/A	13200
2035 Mid-Year Trend		
2035	N/A	15100
2045 Design Year Trend		
2045	N/A	17000
TRANPLAN Forecasts/Trends		

** Annual Trend Increase:	190
Trend R-squared:	91.80%
Trend Annual Historic Growth Rate:	1.74%
Trend Growth Rate (2019 to Design Year):	1.60%
Printed:	29-Oct-20

Straight Line Growth Option

*Axle-Adjusted

Projections of Florida Population by County, 2020–2045, with Estimates for 2019

Stefan Rayer, Population Program Director

Ying Wang, Research Demographer

The Bureau of Economic and Business Research (BEBR) has been making population projections for Florida and its counties since the 1970s. This report presents our most recent set of projections and describes the methodology used to construct those projections. To account for uncertainty regarding future population growth, we publish three series of projections. We believe the medium series is the most likely to provide accurate forecasts in most circumstances, but the low and high series provide an indication of the uncertainty surrounding the medium series. It should be noted that these projections refer solely to permanent residents of Florida; they do not include tourists or seasonal residents.

State projections

The starting point for the state-level projections was the April 1, 2010 census population count by age, sex, race, and Hispanic origin, as adjusted by the National Center for Health Statistics (NCHS) in the Vintage 2017 bridged race population estimates. Projections were made in one-year intervals using a cohort-component methodology in which births, deaths, and migration are projected separately for each age-sex cohort in Florida for non-Hispanic whites, non-Hispanic nonwhites, and Hispanics. We applied three different sets of assumptions to provide low, medium, and high series of projections. Although the

low and high series do not provide absolute bounds on future population change, they provide a reasonable range in which Florida's future population is likely to fall.

Survival rates were applied by single year of age, sex, race, and Hispanic origin to project future deaths in the population. These rates were based on Florida Life Tables for 2007–2013, using mortality data published by the Office of Vital Statistics in the Florida Department of Health. The survival rates were adjusted upward each year until 2044 to account for projected increases in life expectancy. These adjustments were based on projected increases in survival rates released by the U.S. Census Bureau. We used the same mortality assumptions for all three series of projections because there is less uncertainty regarding future changes in mortality rates than is true for migration and fertility rates.

Domestic migration rates by age and sex were based on Public Use Microdata Sample (PUMS) files from the 2005–2009 and 2013–2017 American Community Survey (ACS) 5-year estimates. We chose an average of those two sets of migration estimates because the recession of 2007–2009 had a substantial impact on migration patterns in Florida, affecting in- and out-migration in both time periods; in addition, projections based on more than one time period

tend to be more accurate than those based on a single time period. The 2005–2009 data are the earliest ACS 5-year migration estimates that are available, and the 2013–2017 data were the most recent at the time the state projections were made (early December 2019).

For all three racial/ethnic groups, we applied smoothing techniques to the age/sex-specific migration rates to adjust for data irregularities caused by small sample size. The smoothed in- and out-migration rates were weighted to account for recent changes in Florida’s population growth rates. Projections of domestic in-migration were made by applying weighted in-migration rates to the projected population of the United States (minus Florida), using the most recent set of national projections produced by the U.S. Census Bureau. Projections of out-migration were made by applying weighted out-migration rates to the Florida population. In both instances, rates were calculated separately for males and females by race and ethnicity for each age up to 90 and over.

For the medium projection series, in-migration weights for non-Hispanic whites varied from 1.15 to 1.06, and out-migration weights varied from 0.97 to 0.95; for non-Hispanic nonwhites, in-migration weights varied from 1.12 to 1.03, and out-migration weights varied from 0.99 to 0.96; and for Hispanics, in-migration weights varied from 1.11 to 1.03, and out-migration weights varied from 0.99 to 0.96. For the low projection series, the in-migration weights described above were lowered for all three racial/ethnic groups over time – from 7% in 2020 to 11% in 2045; the out-migration weights were raised by the same margins. For the high projection series, the in-migration weights described above were raised for all three racial/ethnic groups over time – from 7% in 2020 to 11% in 2045; the out-migration weights were lowered by the same margins.

The distribution of foreign immigrants for the three racial/ethnic groups by age and sex was also based on an average of the patterns observed for 2005–2009 and 2013–2017. Again, we smoothed the esti-

mates to account for irregularities in the age/sex distribution of immigrants. For the medium projection series, we held foreign immigration at an average of the 2005–2009 and 2013–2017 levels, with some short-term adjustments based on recent trends. In addition, we made minor adjustments to the racial/ethnic distribution of those migrants based on recent trends. For the low series, foreign immigration was projected to decrease by 1,500 per year from the average of the 2005–2009 and 2013–2017 levels; for the high series, foreign immigration was projected to increase by 1,000 per year. Foreign emigration was assumed to equal 25% of foreign immigration for each series of projections.

Projections were made in one-year intervals, with each projection serving as the base for the following projection. Projected in-migration for each one-year interval was added to the survived Florida population at the end of the interval and projected out-migration was subtracted, giving a projection of the population age one and older.

Births were projected by applying age-specific birth rates (adjusted for child mortality) to the projected female population of each racial/ethnic group. These birth rates were based on Florida birth data for 2007–2013 published by the Office of Vital Statistics in the Florida Department of Health. They imply a total fertility rate (TFR) of 1.66 births per woman for non-Hispanic whites, 2.08 births per woman for non-Hispanic nonwhites, 1.92 births per woman for Hispanics, and 1.83 births per woman for total population. These rates were adjusted in the short-term projections to make them consistent with recent fertility trends. We also raised them long-term, though slightly less than last year. We made this downward adjustment, because recorded resident births in Florida, after having increased each year from 2012 through 2016, have trended downward again over the past three years (the birth data for 2019 are still provisional). By 2033, the adjusted rates imply a total fertility rate of 1.68 births per woman for non-Hispanic whites, 2.12 births per woman for non-Hispanic nonwhites, 1.97 births per woman for Hispanics, and 1.86 births per woman for total population.

As a final step, projections for non-Hispanic whites, non-Hispanic nonwhites, and Hispanics were added together to provide projections of the total population. The medium projections of total population for 2020–2024 were adjusted to be consistent with the state population forecasts for those years produced by the State of Florida’s Demographic Estimating Conference (DEC) held December 3, 2019. None of the projections after 2024 had any further adjustments. In this publication, we provide projections for 2020, 2025, 2030, 2035, 2040, and 2045. State projections for other years are available by request.

County projections

The cohort-component method is a good way to make population projections at the state level, but is not necessarily the best way to make projections at the county level. Many counties in Florida are so small that the number of persons in each age-sex category is inadequate for making reliable cohort-component projections, given the lack of detailed small-area data. Even more important, county growth patterns are so volatile that a single technique based on data from a single time period may provide misleading results. We believe more useful projections of total population can be made by using several different techniques and historical base periods.

For counties, we started with the population estimate constructed by BEBR for April 1, 2019. We made projections for each county using five different techniques. After 2020, the projections were made in five-year increments. The five techniques were:

1. Linear – the population will change by the same number of persons in each future year as the average annual change during the base period.
2. Exponential – the population will change at the same percentage rate in each future year as the average annual rate during the base period.
3. Share-of-growth – each county’s share of state population growth in the future will be the same as its share during the base period.

4. Shift-share – each county’s share of the state population will change by the same annual amount in the future as the average annual change during the base period.

5. Constant-share – each county’s share of the state population will remain constant at its 2019 level.

For the linear and share-of-growth techniques we used base periods of two, ten, and twenty years (2017–2019, 2009–2019, and 1999–2019), yielding three sets of projections for each technique. For the exponential and shift-share techniques we used base periods of five and fifteen years (2014–2019 and 2004–2019), yielding two sets of projections for each technique. The constant-share method was based on data for a single year (2019).

This methodology produced eleven projections for each county for each projection year (2020, 2025, 2030, 2035, 2040, and 2045). From these, we calculated five averages: one using all eleven projections (AVE-11), one that excluded the highest and lowest projections (AVE-9), one that excluded the two highest and two lowest projections (AVE-7), one that excluded the three highest and three lowest projections (AVE-5), and one that excluded the four highest and four lowest projections (AVE-3). Based on the results of previous research, we designated the average that excluded the three highest and three lowest projections (AVE-5) as the default technique for each county. We evaluated the resulting projections by comparing them with historical population trends and with the level of population growth projected for the state as a whole. For counties in which AVE-5 did not provide reasonable projections, we selected the technique producing projections that fit most closely with our evaluation criteria.

For 66 counties we selected AVE-5, the average in which the three highest and three lowest projections were excluded. For Monroe County, we selected an average of projections made with the exponential technique with a base period of five years and the linear technique with a base period of two years. In

addition, we made manual adjustments to the projections in six counties in the Florida Panhandle to account for estimated population losses or slowdowns in growth due to the impacts of Hurricane Michael (Bay, Calhoun, Gadsden, Gulf, Jackson, and Liberty counties).

We also made adjustments in several counties to account for changes in institutional populations such as university students and prison inmates. Adjustments were made only in counties in which institutional populations account for a large proportion of total population or where changes in the institutional population have been substantially different than changes in the rest of the population. In the present set of projections, adjustments were made for Alachua, Baker, Bradford, Calhoun, Columbia, DeSoto, Dixie, Franklin, Gadsden, Gilchrist, Glades, Gulf, Hamilton, Hardee, Hendry, Holmes, Jackson, Jefferson, Lafayette, Leon, Liberty, Madison, Okeechobee, Santa Rosa, Sumter, Suwannee, Taylor, Union, Wakulla, Walton, and Washington counties.

Range of county projections

The techniques described in the previous section were used to construct the medium series of county projections. This is the series we believe will generally provide the most accurate forecasts of future population change. We also constructed low and high projections to provide an indication of the uncertainty surrounding the medium county projections. The low and high projections were based on analyses of past population forecast errors for counties in Florida, broken down by population size and growth rate. They indicate the range into which approximately three-quarters of future county populations will fall, if the future distribution of forecast errors is similar to the past distribution.

The range between the low and high projections varies according to a county's population size in 2019 (less than 30,000; 30,000 to 199,999; and 200,000 or more), rate of population growth between 2009 and 2019 (less than 7.5%; 7.5–15%; 15–30%; and 30% or more), and the length of the projection horizon (on average, projection errors grow with the length of the projection horizon). Our studies have found that the distribution of absolute percent errors tends to remain fairly stable over time, leading us to believe that the low and high projections provide a reasonable range of errors for most counties. It must be emphasized, however, that the actual future population of any given county could be below the low projection or above the high projection.

For the medium series of projections, the sum of the county projections equals the state projection for each year (except for slight differences due to rounding). For the low and high series, however, the sum of the county projections does not equal the state projection. The sum of the low projections for counties is lower than the state's low projection and the sum of the high projections for counties is higher than the state's high projection. This occurs because potential variation around the medium projection is greater for counties than for the state as a whole.

Acknowledgement

Funding for these projections was provided by the Florida Legislature.

Copyright © 2020 by the University of Florida.

Projections of Florida Population by County, 2020–2045, with Estimates for 2019

County and State	Estimates April 1, 2019	Projections, April 1					
		2020	2025	2030	2035	2040	2045
ALACHUA	267,306						
Low		258,900	262,300	264,300	265,100	264,500	262,300
Medium		269,800	281,500	291,600	300,200	307,400	313,300
High		280,500	299,400	318,000	334,300	348,800	361,400
BAKER	28,249						
Low		27,100	27,500	27,700	27,700	27,600	27,300
Medium		28,500	29,900	31,100	32,000	32,900	33,600
High		29,900	32,400	34,900	37,300	39,700	41,900
BAY	167,283						
Low		168,500	173,300	176,400	178,400	179,400	179,700
Medium		175,300	185,700	193,700	200,300	206,000	210,900
High		182,500	198,500	213,700	228,000	241,000	253,800
BRADFORD	28,682						
Low		27,400	26,900	26,300	25,600	24,900	24,300
Medium		28,800	29,200	29,500	29,800	30,000	30,300
High		30,200	31,700	33,100	34,500	35,900	37,200
BREVARD	594,469						
Low		577,900	594,000	603,000	608,300	610,400	612,200
Medium		602,400	637,600	665,000	687,900	707,400	726,000
High		626,000	678,100	725,700	766,900	805,100	843,700
BROWARD	1,919,644						
Low		1,862,500	1,899,500	1,917,100	1,924,900	1,923,700	1,920,500
Medium		1,941,200	2,039,000	2,115,200	2,179,100	2,233,900	2,285,100
High		2,017,700	2,168,500	2,307,300	2,426,900	2,537,300	2,646,600
CALHOUN	14,067						
Low		14,100	14,200	14,100	13,900	13,800	13,600
Medium		14,900	15,400	15,800	16,200	16,500	16,800
High		15,600	16,700	17,800	18,800	19,800	20,800
CHARLOTTE	181,770						
Low		175,300	181,500	185,200	187,200	188,200	188,900
Medium		184,700	198,100	208,700	217,400	225,200	232,500
High		193,800	213,800	232,500	250,200	266,900	284,600
CITRUS	147,744						
Low		143,300	146,600	149,000	150,300	150,800	150,900
Medium		149,400	157,100	163,600	168,900	173,400	177,300
High		155,300	168,000	180,400	192,100	202,600	213,100
CLAY	215,246						
Low		210,100	220,600	229,300	235,200	239,300	242,400
Medium		219,000	236,800	252,500	265,000	275,600	285,100
High		227,600	251,800	276,000	296,600	315,700	334,100
COLLIER	376,706						
Low		365,000	385,500	400,300	410,800	416,600	420,100
Medium		384,600	421,200	451,700	477,200	498,400	517,400
High		403,400	451,600	497,500	538,500	575,500	611,300
COLUMBIA	70,492						
Low		67,700	68,600	69,200	69,300	69,100	68,700
Medium		70,500	73,500	76,000	78,000	79,700	81,200
High		73,300	78,600	83,800	88,600	92,900	97,100
DESOTO	36,065						
Low		34,900	35,000	34,800	34,500	34,100	33,500
Medium		36,300	37,500	38,300	38,900	39,500	39,900
High		37,800	40,100	42,200	44,100	45,700	47,400
DIXIE	16,610						
Low		15,900	15,500	15,100	14,600	14,200	13,700
Medium		16,700	16,900	17,000	17,100	17,100	17,100
High		17,500	18,300	19,000	19,700	20,300	21,000

Projections of Florida Population by County, 2020–2045, with Estimates for 2019 (continued)

County and State	Estimates April 1, 2019	Projections, April 1					
		2020	2025	2030	2035	2040	2045
DUVAL	970,672						
Low		945,300	979,800	1,001,700	1,017,300	1,024,700	1,025,400
Medium		985,500	1,051,900	1,104,300	1,148,700	1,185,300	1,216,200
High		1,024,100	1,118,600	1,205,600	1,282,700	1,351,600	1,413,100
ESCAMBIA	321,134						
Low		314,100	319,200	321,500	322,100	321,800	321,600
Medium		324,000	336,400	345,800	353,000	359,300	365,200
High		333,600	354,800	374,200	389,700	404,100	418,200
FLAGLER	110,635						
Low		106,500	113,900	119,900	124,500	127,700	129,600
Medium		113,400	126,500	138,300	148,400	157,300	165,200
High		120,000	137,700	155,800	173,600	190,500	207,500
FRANKLIN	12,273						
Low		11,600	11,500	11,400	11,200	11,000	10,800
Medium		12,200	12,500	12,800	13,100	13,200	13,400
High		12,800	13,600	14,400	15,200	15,900	16,600
GADSDEN	46,277						
Low		44,500	43,900	42,800	41,700	40,600	39,500
Medium		46,300	47,000	47,100	47,200	47,300	47,400
High		48,300	50,300	51,800	53,300	54,500	55,700
GILCHRIST	17,766						
Low		17,100	17,400	17,600	17,600	17,500	17,400
Medium		18,000	18,900	19,700	20,400	20,900	21,400
High		18,900	20,500	22,200	23,700	25,200	26,700
GLADES	13,121						
Low		12,600	12,400	12,200	12,000	11,700	11,500
Medium		13,200	13,500	13,700	13,900	14,100	14,200
High		13,900	14,700	15,400	16,200	16,800	17,600
GULF	13,082						
Low		14,000	14,000	14,000	13,800	13,700	13,500
Medium		14,700	15,300	15,700	16,000	16,400	16,600
High		15,500	16,500	17,600	18,600	19,700	20,700
HAMILTON	14,600						
Low		13,900	13,600	13,200	12,800	12,300	11,900
Medium		14,600	14,800	14,900	14,900	14,900	15,000
High		15,300	16,000	16,600	17,200	17,700	18,300
HARDEE	27,385						
Low		26,200	25,400	24,600	23,800	23,000	22,200
Medium		27,600	27,600	27,700	27,800	27,800	27,900
High		28,900	30,000	31,000	32,100	33,100	34,100
HENDRY	40,120						
Low		38,900	39,400	39,600	39,500	39,400	39,300
Medium		40,500	42,200	43,500	44,500	45,500	46,400
High		42,100	45,200	48,000	50,600	53,000	55,500
HERNANDO	188,358						
Low		181,700	188,900	194,300	197,200	198,300	198,100
Medium		191,500	206,100	218,900	228,900	237,200	244,400
High		200,900	222,500	244,000	263,600	281,200	298,500
HIGHLANDS	103,434						
Low		100,000	100,700	100,800	100,400	99,700	98,900
Medium		104,200	107,800	110,800	113,200	115,200	117,100
High		108,300	115,300	122,100	128,400	133,900	139,700
HILLSBOROUGH	1,444,870						
Low		1,399,100	1,474,700	1,525,600	1,555,200	1,577,000	1,590,200
Medium		1,474,300	1,611,300	1,721,600	1,809,000	1,887,700	1,959,200
High		1,546,400	1,727,500	1,895,700	2,038,500	2,178,600	2,314,000

Projections of Florida Population by County, 2020–2045, with Estimates for 2019 (continued)

County and State	Estimates April 1, 2019	Projections, April 1					
		2020	2025	2030	2035	2040	2045
HOLMES	20,049						
Low		19,200	18,700	18,100	17,500	17,000	16,400
Medium		20,200	20,300	20,400	20,400	20,500	20,500
High		21,200	22,000	22,800	23,600	24,400	25,100
INDIAN RIVER	154,939						
Low		149,600	155,700	160,000	162,100	163,000	162,800
Medium		157,600	170,000	180,200	188,200	195,000	200,900
High		165,400	183,400	200,900	216,700	231,100	245,300
JACKSON	46,969						
Low		45,400	44,500	43,400	42,400	41,300	40,200
Medium		47,100	47,600	47,800	48,000	48,100	48,300
High		49,100	50,900	52,600	54,100	55,500	56,800
JEFFERSON	14,776						
Low		14,100	13,900	13,600	13,300	12,900	12,600
Medium		14,800	15,100	15,300	15,400	15,600	15,700
High		15,600	16,400	17,200	17,900	18,600	19,300
LAFAYETTE	8,482						
Low		8,300	8,400	8,400	8,400	8,300	8,200
Medium		8,700	9,100	9,400	9,700	9,900	10,100
High		9,100	9,900	10,600	11,300	11,900	12,600
LAKE	357,247						
Low		347,800	376,000	399,700	417,200	429,500	438,400
Medium		366,600	410,900	450,300	482,700	510,300	534,800
High		384,400	440,400	496,700	546,800	593,400	638,000
LEE	735,148						
Low		714,200	764,600	802,400	829,000	848,300	863,900
Medium		752,800	835,500	904,700	961,400	1,010,900	1,056,600
High		789,400	895,600	997,000	1,086,600	1,171,800	1,257,100
LEON	296,499						
Low		287,600	293,300	296,900	298,400	298,100	296,900
Medium		299,800	314,900	327,500	337,800	346,200	353,700
High		311,600	334,900	357,400	376,300	393,200	409,100
LEVY	41,330						
Low		39,900	39,900	39,700	39,300	38,800	38,200
Medium		41,600	42,700	43,600	44,300	44,900	45,500
High		43,200	45,700	48,000	50,200	52,100	54,000
LIBERTY	8,772						
Low		8,300	8,300	8,300	8,300	8,300	8,200
Medium		8,800	9,100	9,400	9,600	9,900	10,100
High		9,200	9,800	10,500	11,200	11,900	12,500
MADISON	19,570						
Low		18,300	17,900	17,500	17,000	16,600	16,100
Medium		19,200	19,500	19,700	19,800	20,000	20,100
High		20,200	21,100	22,000	23,000	23,800	24,700
MANATEE	387,414						
Low		375,600	397,700	413,500	425,400	435,600	442,900
Medium		395,800	434,600	466,500	493,800	519,200	542,200
High		415,100	465,900	513,800	557,600	601,800	644,500
MARION	360,421						
Low		351,000	365,200	376,500	383,700	388,000	389,700
Medium		365,900	392,100	414,800	432,800	447,900	460,800
High		380,300	416,900	453,100	483,700	511,700	537,000
MARTIN	158,598						
Low		152,400	155,400	156,800	157,100	156,700	155,800
Medium		160,600	169,500	176,900	182,900	188,200	193,000
High		168,500	183,000	196,900	210,000	222,200	234,700

Projections of Florida Population by County, 2020–2045, with Estimates for 2019 (continued)

County and State	Estimates April 1, 2019	Projections, April 1					
		2020	2025	2030	2035	2040	2045
MIAMI-DADE	2,812,130						
Low		2,734,000	2,815,500	2,873,400	2,917,900	2,938,500	2,944,500
Medium		2,849,900	3,022,600	3,167,900	3,294,700	3,399,200	3,489,900
High		2,961,800	3,214,300	3,458,200	3,679,000	3,875,800	4,057,700
MONROE	76,212						
Low		73,200	71,500	69,800	68,100	66,400	64,700
Medium		76,300	76,500	76,800	77,100	77,400	77,700
High		79,300	81,900	84,500	87,000	89,200	91,400
NASSAU	85,070						
Low		81,600	86,200	89,400	91,200	92,100	92,500
Medium		86,900	95,800	103,100	109,100	114,300	118,900
High		92,100	104,300	116,100	127,200	137,500	148,000
OKALOOSA	201,514						
Low		195,500	199,600	202,500	203,600	203,900	203,900
Medium		203,800	214,300	223,300	230,400	236,600	242,300
High		211,800	227,900	243,700	256,800	269,000	280,900
OKEECHOBEE	41,808						
Low		40,400	40,600	40,400	40,200	39,800	39,400
Medium		42,100	43,400	44,400	45,300	46,000	46,700
High		43,800	46,500	48,900	51,300	53,500	55,700
ORANGE	1,386,080						
Low		1,346,300	1,439,500	1,504,600	1,548,500	1,584,300	1,610,900
Medium		1,418,900	1,573,000	1,696,800	1,797,400	1,888,700	1,972,200
High		1,488,000	1,686,200	1,869,600	2,029,700	2,188,600	2,344,100
OSCEOLA	370,552						
Low		361,000	406,300	442,500	469,700	491,000	508,900
Medium		384,800	452,100	510,200	558,900	602,200	642,600
High		407,000	488,400	568,000	640,700	711,600	783,900
PALM BEACH	1,447,857						
Low		1,406,300	1,441,300	1,465,900	1,483,700	1,494,900	1,497,500
Medium		1,465,800	1,547,200	1,616,500	1,676,600	1,729,500	1,775,200
High		1,523,500	1,645,400	1,764,200	1,870,700	1,971,800	2,063,600
PASCO	527,122						
Low		515,300	545,800	569,400	585,600	597,100	605,200
Medium		537,300	586,100	626,800	659,200	686,700	711,000
High		558,300	623,100	685,200	738,300	787,600	833,900
PINELLAS	978,045						
Low		955,000	962,400	962,500	957,600	953,600	948,200
Medium		984,900	1,014,400	1,035,600	1,051,300	1,066,600	1,080,600
High		1,014,100	1,069,900	1,120,200	1,158,700	1,197,400	1,233,300
POLK	690,606						
Low		668,200	701,500	723,800	737,600	745,000	748,800
Medium		704,100	766,400	817,000	858,000	893,100	924,700
High		738,500	821,700	899,500	966,700	1,029,200	1,089,600
PUTNAM	73,268						
Low		70,400	68,700	66,900	65,300	63,500	61,800
Medium		73,300	73,600	73,700	73,900	74,100	74,300
High		76,300	78,700	81,100	83,400	85,400	87,300
ST. JOHNS	254,412						
Low		247,500	278,000	301,300	318,500	332,400	343,900
Medium		263,900	309,300	347,600	379,400	408,100	434,900
High		279,200	334,200	386,800	434,500	481,800	529,700
ST. LUCIE	309,359						
Low		302,300	319,300	333,800	344,300	352,000	357,600
Medium		315,200	342,900	367,500	387,400	404,400	419,400
High		327,500	364,600	401,700	434,100	464,300	492,800

Projections of Florida Population by County, 2020–2045, with Estimates for 2019 (continued)

County and State	Estimates April 1, 2019	Projections, April 1					
		2020	2025	2030	2035	2040	2045
SANTA ROSA	179,054						
Low		171,600	179,700	184,800	188,000	189,300	189,500
Medium		182,800	199,600	213,400	225,100	235,100	244,200
High		193,600	217,400	240,100	262,100	282,500	303,400
SARASOTA	426,275						
Low		415,600	433,000	444,200	452,400	459,000	463,900
Medium		433,300	464,900	489,600	510,500	529,400	546,500
High		450,200	494,300	534,600	570,400	605,400	639,200
SEMINOLE	471,735						
Low		459,300	475,700	485,800	493,100	496,900	498,500
Medium		478,800	510,700	535,600	556,900	574,700	590,400
High		497,600	543,100	584,700	621,800	655,400	686,900
SUMTER	128,633						
Low		122,800	134,700	144,600	151,000	155,700	158,800
Medium		132,300	152,300	170,800	185,700	199,100	211,500
High		141,300	167,400	194,500	219,800	245,000	270,800
SUWANNEE	45,423						
Low		44,000	45,100	45,900	46,400	46,500	46,500
Medium		45,900	48,300	50,400	52,100	53,500	54,700
High		47,700	51,700	55,600	59,300	62,500	65,700
TAYLOR	22,458						
Low		21,500	21,300	21,000	20,700	20,300	19,900
Medium		22,600	23,200	23,600	24,000	24,300	24,700
High		23,800	25,100	26,500	27,800	29,200	30,600
UNION	15,505						
Low		14,700	14,300	13,900	13,400	12,900	12,400
Medium		15,500	15,600	15,600	15,700	15,700	15,700
High		16,300	16,900	17,500	18,100	18,600	19,100
VOLUSIA	538,763						
Low		523,000	534,500	540,000	541,900	542,700	542,400
Medium		545,200	573,800	595,800	613,600	629,700	644,700
High		566,600	610,200	650,000	683,300	715,800	747,400
WAKULLA	32,976						
Low		31,600	32,400	33,000	33,100	33,000	32,700
Medium		33,300	35,400	37,200	38,500	39,600	40,600
High		34,900	38,200	41,400	44,300	46,800	49,300
WALTON	70,071						
Low		67,600	73,400	77,700	80,800	83,000	84,800
Medium		72,100	81,500	89,600	96,200	102,200	107,700
High		76,300	88,800	101,000	112,600	123,900	135,700
WASHINGTON	25,387						
Low		23,900	23,800	23,600	23,200	22,800	22,300
Medium		25,200	25,900	26,500	27,000	27,300	27,700
High		26,500	28,100	29,700	31,300	32,700	34,200
FLORIDA	21,208,589						
Low		20,926,300	22,105,500	22,970,200	23,580,900	24,020,900	24,340,400
Medium		21,556,000	23,130,900	24,426,200	25,498,000	26,428,700	27,266,900
High		22,173,900	24,133,900	25,847,700	27,370,100	28,783,400	30,135,700

FLORIDA DEPARTMENT OF TRANSPORTATION



FLORIDA POPULATION PROJECTIONS FROM 2020 TO 2045

WITH 2010 CENSUS AND 2016 ESTIMATES

District Summary by County	US Census April 1, 2010	Current Estimate April 1, 2016	Population Projections, April 1					
			2020	2025	2030	2035	2040	2045
District 1	2,658,027	2,861,841	3,079,400	3,331,000	3,545,400	3,744,400	3,921,100	4,084,300
Charlotte	159,978	170,450	180,100	191,000	200,400	208,400	215,600	222,100
Collier	321,520	350,202	379,200	413,000	442,000	469,200	493,800	516,000
DeSoto	34,862	35,141	35,900	36,700	37,500	38,200	38,700	39,200
Glades	12,884	13,047	13,500	14,000	14,400	14,700	15,000	15,300
Hardee	27,731	27,637	27,800	27,900	28,100	28,200	28,300	28,300
Hendry	39,140	38,370	39,200	40,100	40,600	41,100	41,700	42,100
Highlands	98,786	101,531	105,400	109,600	113,000	115,600	117,600	119,600
Lee	618,754	680,539	748,900	828,100	895,900	962,900	1,024,700	1,081,700
Manatee	322,833	357,591	388,700	425,700	458,700	487,700	511,800	535,200
Okeechobee	39,996	40,806	41,900	43,100	44,000	44,700	45,300	45,900
Polk	602,095	646,989	698,000	757,200	806,800	853,700	896,400	935,200
Sarasota	379,448	399,538	420,800	444,600	464,000	480,000	492,200	503,700
District 2	1,960,058	2,079,483	2,204,300	2,348,700	2,477,300	2,593,600	2,694,500	2,788,200
Alachua	247,336	257,062	265,500	275,200	283,100	290,300	296,700	302,700
Baker	27,115	26,965	27,800	28,700	29,500	30,100	30,600	31,100
Bradford	28,520	27,440	28,800	29,300	29,500	29,700	29,900	30,100
Clay	190,865	205,321	223,400	244,200	262,100	278,700	294,100	308,300
Columbia	67,531	68,566	71,100	73,700	75,800	77,600	79,100	80,300
Dixie	16,422	16,773	17,200	17,700	18,100	18,400	18,700	18,900
Duval	864,263	923,647	975,500	1,035,100	1,089,300	1,138,500	1,179,900	1,218,700
Gilchrist	16,939	16,848	17,500	18,400	19,000	19,600	20,100	20,500
Hamilton	14,799	14,665	15,300	15,600	15,900	16,200	16,400	16,600
Lafayette	8,870	8,621	8,900	9,200	9,500	9,800	10,000	10,200
Levy	40,801	40,553	41,700	43,000	44,100	44,900	45,600	46,200
Madison	19,224	19,238	19,400	19,500	19,600	19,700	19,800	19,900
Nassau	73,314	77,841	83,900	91,200	97,600	103,400	108,700	113,500
Putnam	74,364	72,972	73,100	73,600	74,000	74,300	74,600	74,800
St. Johns	190,039	220,257	250,500	287,000	320,800	351,100	377,500	402,200
Suwannee	41,551	44,349	46,000	47,800	49,300	50,600	51,800	52,700
Taylor	22,570	22,478	22,400	22,700	23,000	23,200	23,300	23,500
Union	15,535	15,887	16,300	16,800	17,100	17,500	17,700	18,000
District 3	1,366,092	1,438,229	1,502,900	1,577,000	1,638,700	1,691,600	1,737,800	1,780,800
Bay	168,852	176,016	184,700	194,600	202,700	209,400	215,100	220,700
Calhoun	14,625	14,580	14,900	15,200	15,400	15,600	15,700	15,900
Escambia	297,619	309,986	317,100	325,500	332,900	338,200	342,200	345,800
Franklin	11,549	11,916	12,100	12,400	12,600	12,800	12,900	13,000
Gadsden	46,389	48,486	49,200	49,900	50,600	51,300	51,900	52,300
Gulf	15,863	16,628	17,100	17,700	18,100	18,500	18,800	19,100
Holmes	19,927	20,003	20,200	20,400	20,500	20,500	20,500	20,600
Jackson	49,746	50,345	50,900	51,400	51,800	52,100	52,500	52,800
Jefferson	14,761	14,498	14,700	14,900	15,000	15,100	15,100	15,200

FLORIDA DEPARTMENT OF TRANSPORTATION



FLORIDA POPULATION PROJECTIONS FROM 2020 TO 2045

WITH 2010 CENSUS AND 2016 ESTIMATES

District Summary by County	US Census April 1, 2010	Current Estimate April 1, 2016	Population Projections, April 1					
			2020	2025	2030	2035	2040	2045
District 3 (continued)								
Leon	275,487	287,671	301,800	318,300	332,500	344,600	354,500	363,600
Liberty	8,365	8,736	9,200	9,700	10,100	10,500	10,800	11,100
Okaloosa	180,822	192,925	200,400	208,300	214,300	220,100	225,000	229,700
Santa Rosa	151,372	167,009	181,400	197,900	211,700	223,700	235,300	246,300
Wakulla	30,776	31,599	33,300	35,400	37,100	38,600	40,000	41,200
Walton	55,043	62,943	70,400	79,300	86,800	93,700	100,300	106,100
Washington	24,896	24,888	25,500	26,100	26,600	26,900	27,200	27,400
District 4	3,630,335	3,836,360	4,039,300	4,271,600	4,462,300	4,627,300	4,774,100	4,910,800
Broward	1,748,066	1,854,513	1,940,700	2,038,400	2,117,200	2,182,300	2,237,900	2,290,800
Indian River	138,028	146,410	156,600	168,400	178,300	186,900	194,800	201,800
Martin	146,318	150,870	157,500	164,300	169,700	174,300	178,100	181,300
Palm Beach	1,320,134	1,391,741	1,465,900	1,550,600	1,619,100	1,679,700	1,735,100	1,786,600
St. Lucie	277,789	292,826	318,600	349,900	378,000	404,100	428,200	450,300
District 5	3,692,794	4,030,109	4,367,000	4,766,300	5,110,700	5,411,500	5,683,900	5,936,200
Brevard	543,376	568,919	595,700	625,500	649,200	666,300	681,700	696,100
Flagler	95,696	103,095	115,300	130,000	143,400	156,000	167,900	178,900
Lake	297,047	323,985	355,300	391,600	422,800	451,300	478,400	503,600
Marion	331,303	345,749	367,500	392,800	414,800	434,700	452,000	467,600
Orange	1,145,956	1,280,387	1,404,500	1,553,800	1,682,300	1,794,300	1,898,600	1,995,100
Osceola	268,685	322,862	372,800	435,200	491,200	537,600	577,600	616,300
Seminole	422,718	449,124	474,700	504,000	528,400	550,700	570,300	588,000
Sumter	93,420	118,577	140,900	168,100	192,600	216,000	236,400	255,200
Volusia	494,593	517,411	540,300	565,300	586,000	604,600	621,000	635,400
District 6	2,569,547	2,776,841	2,937,600	3,125,100	3,296,900	3,451,400	3,592,900	3,719,700
Miami-Dade	2,496,457	2,700,794	2,861,400	3,048,600	3,220,000	3,374,200	3,515,800	3,642,700
Monroe	73,090	76,047	76,200	76,500	76,900	77,200	77,100	77,000
District 7	2,924,479	3,125,791	3,308,600	3,524,200	3,712,800	3,877,500	4,022,000	4,158,600
Citrus	141,236	143,054	148,400	154,500	159,600	163,800	167,100	170,000
Hernando	172,778	179,503	191,100	204,600	216,300	227,000	236,200	244,400
Hillsborough	1,229,226	1,352,797	1,466,900	1,602,900	1,722,900	1,824,900	1,919,900	2,007,100
Pasco	464,697	495,868	534,800	579,800	618,300	653,900	686,000	715,800
Pinellas	916,542	954,569	967,400	982,400	995,700	1,007,900	1,012,800	1,021,300
Florida	18,801,332	20,148,654	21,439,100	22,943,900	24,244,100	25,397,300	26,426,300	27,378,600

SOURCES:

U.S. Department of Commerce - Bureau of the Census
 University of Florida - Bureau of Economic and Business Research

NOTE:

County totals are rounded to the nearest 100 persons, county may not add to statewide totals due to rounding.

Population: Census, Estimates & Projections

FDOT District 1

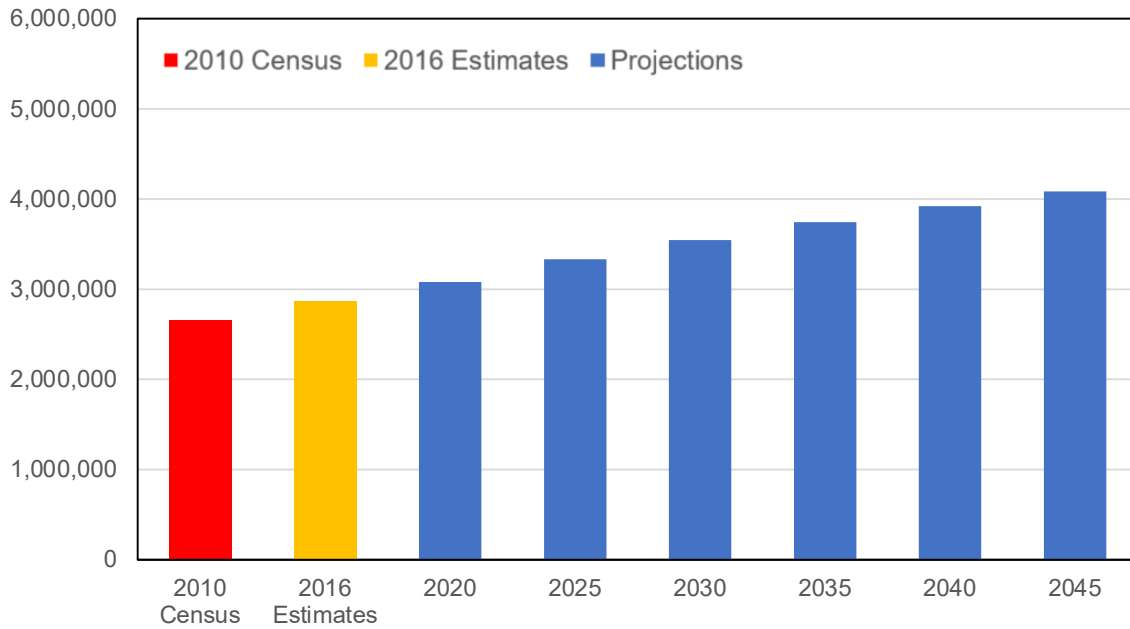

Population: Census, Estimates & Projections

FDOT District 2

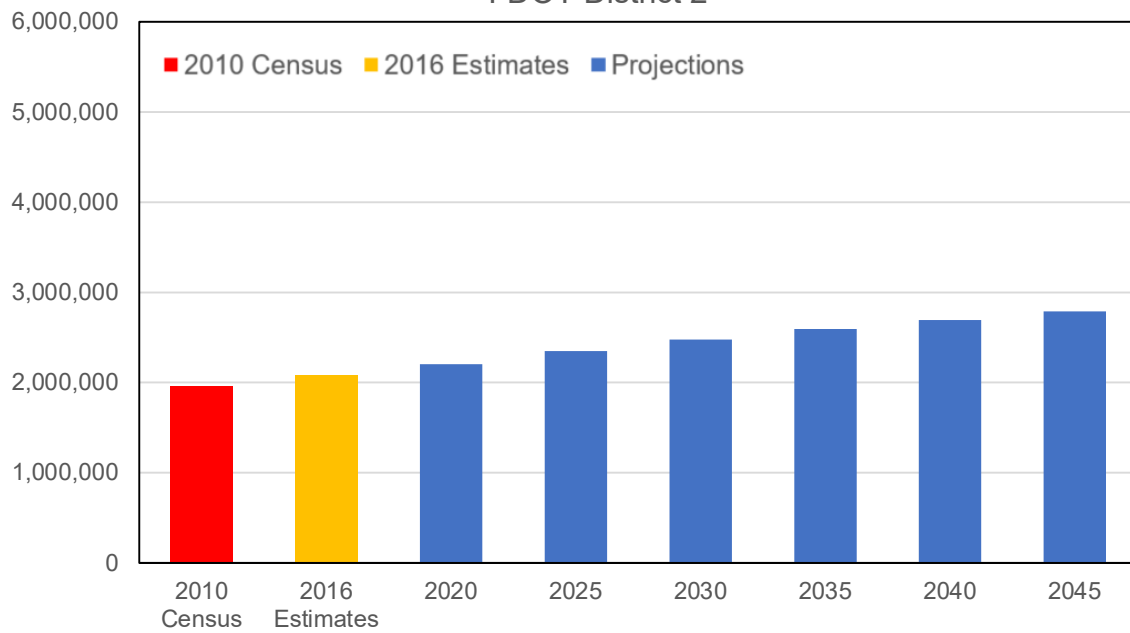

Population: Census, Estimates & Projections

FDOT District 3

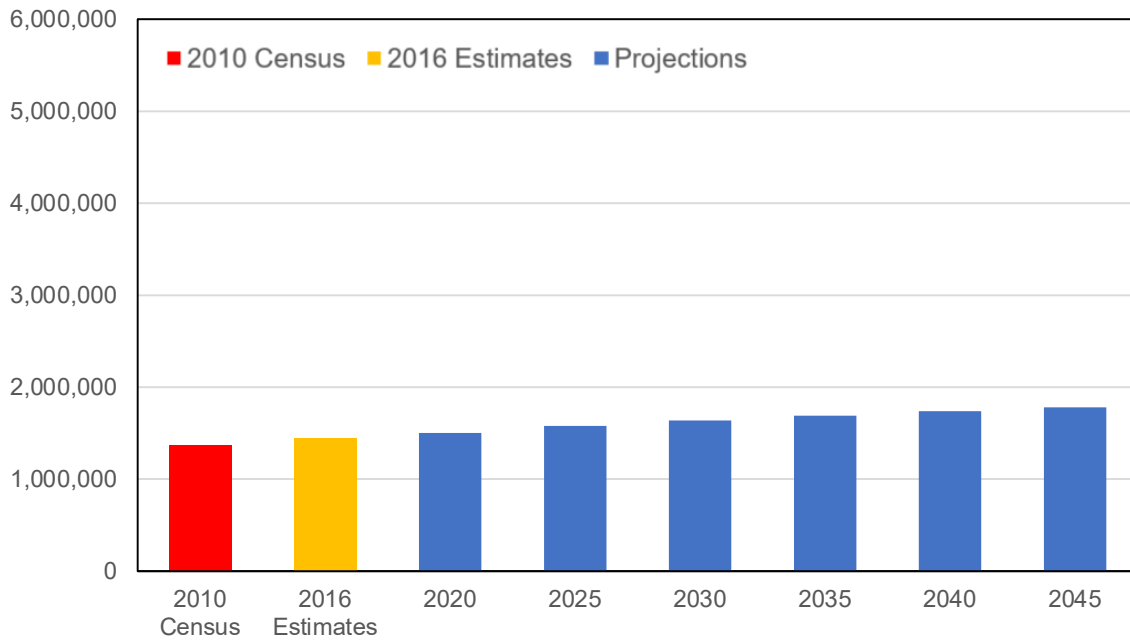

Population: Census, Estimates and Projections

FDOT District 4

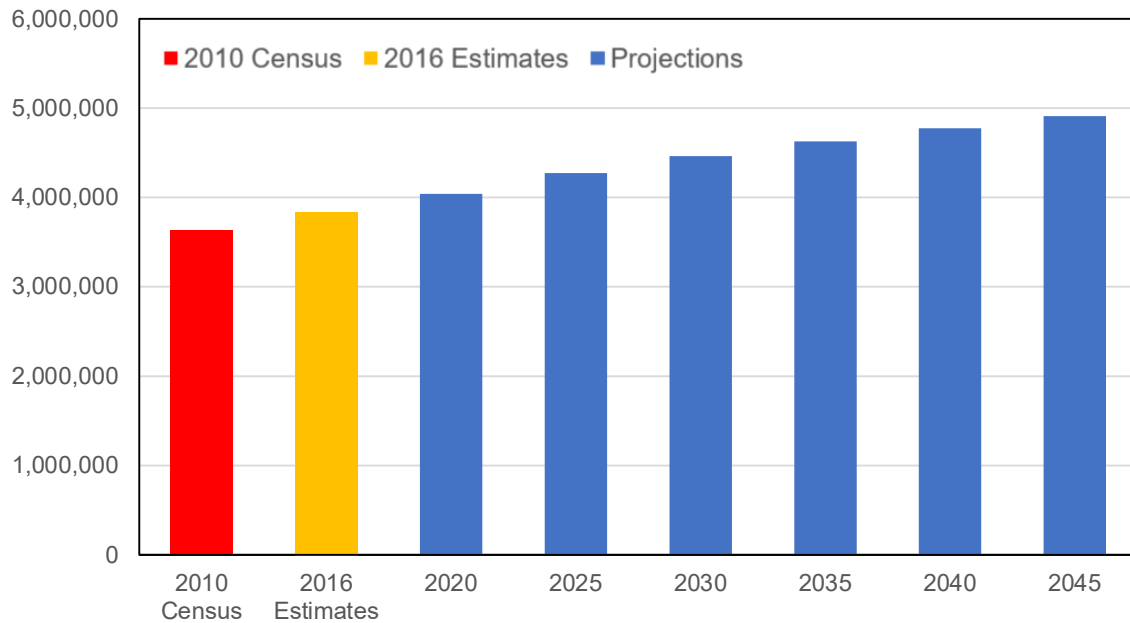

Population: Census, Estimates & Projections

FDOT District 5

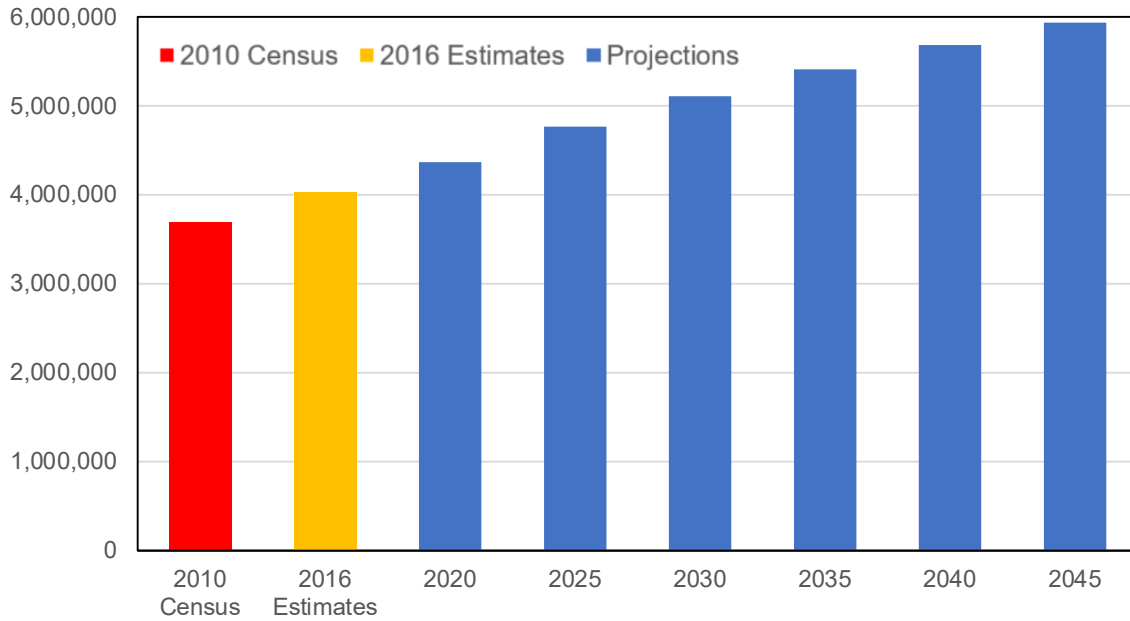

Population: Census, Estimates & Projections

FDOT District 6

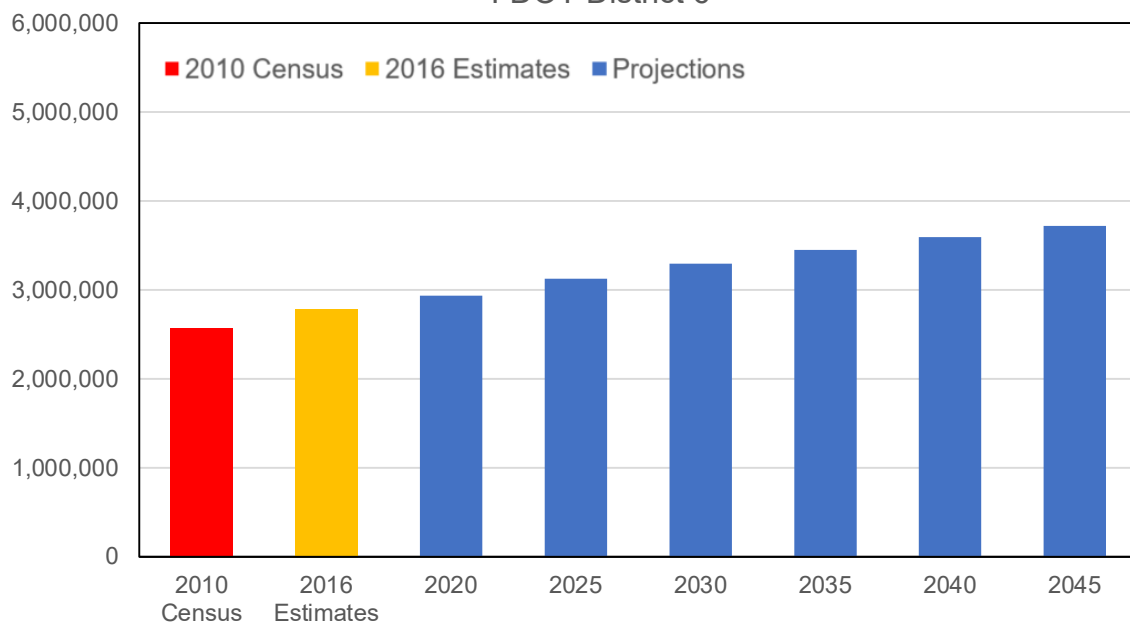

Population: Census, Estimates & Projections

FDOT District 7

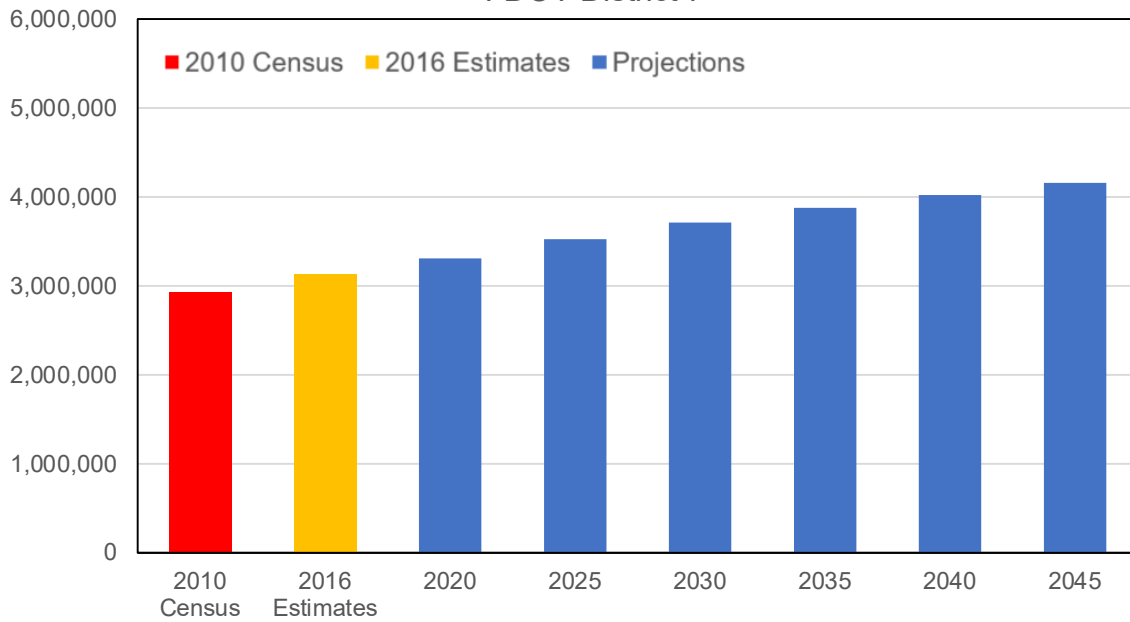

Population: Census, Estimates & Projections

Statewide

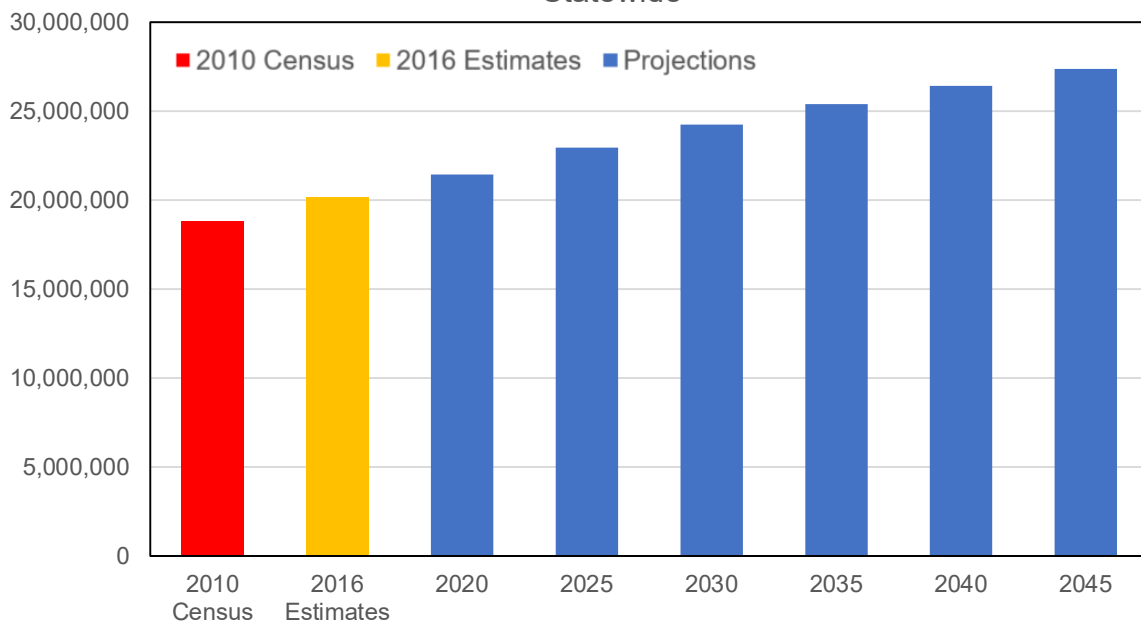

Appendix C

Travel Time and Speed Data

120 sec

Parental Homes Road - 12/9/2020 - AM Peak

North →

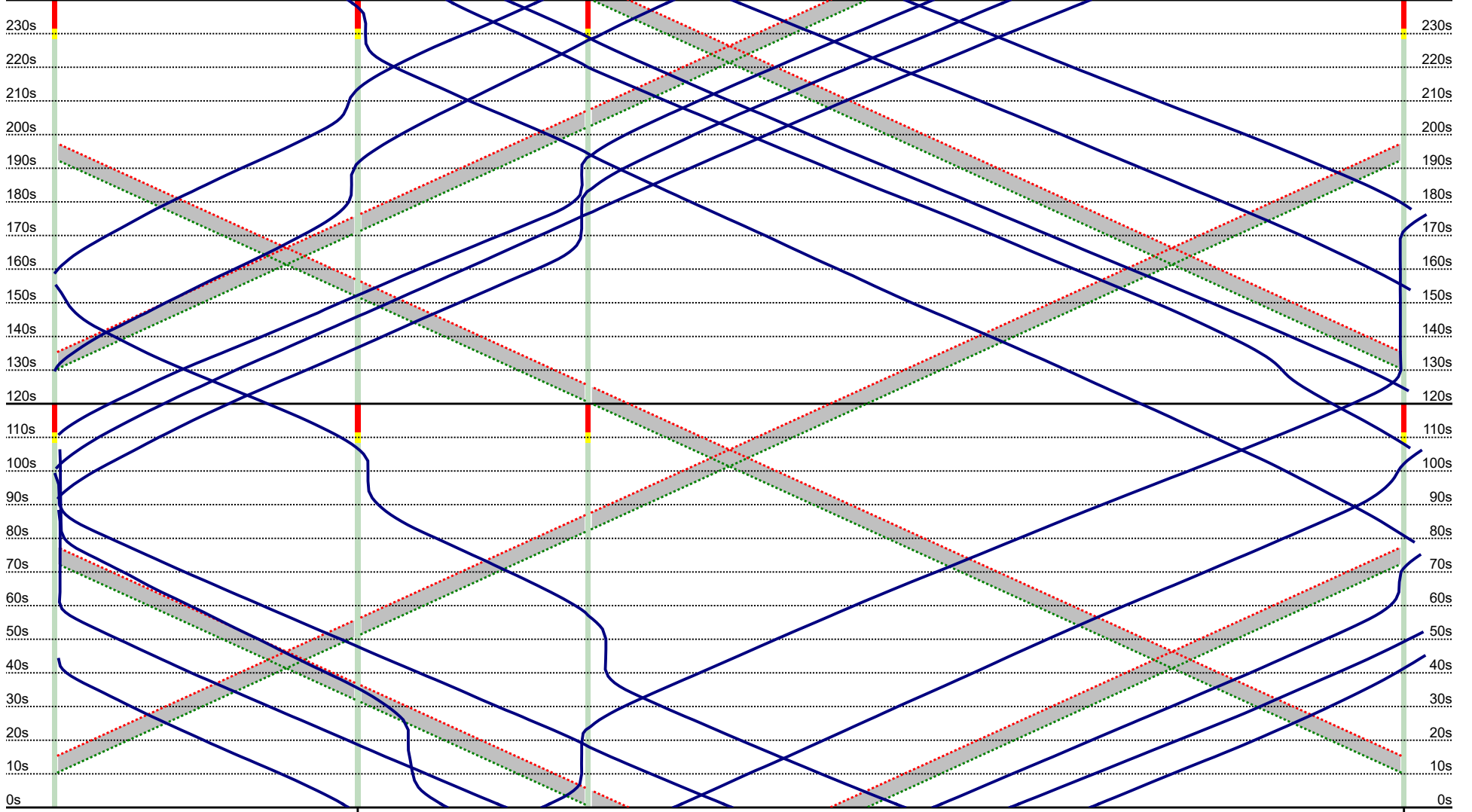

Bowden Rd

Barnes Rd

Dean Rd

Hogan Rd

2108 ft

1602 ft

5671 ft

120 sec

Parental Homes Road - 12/9/2020 - Midday Peak

North →

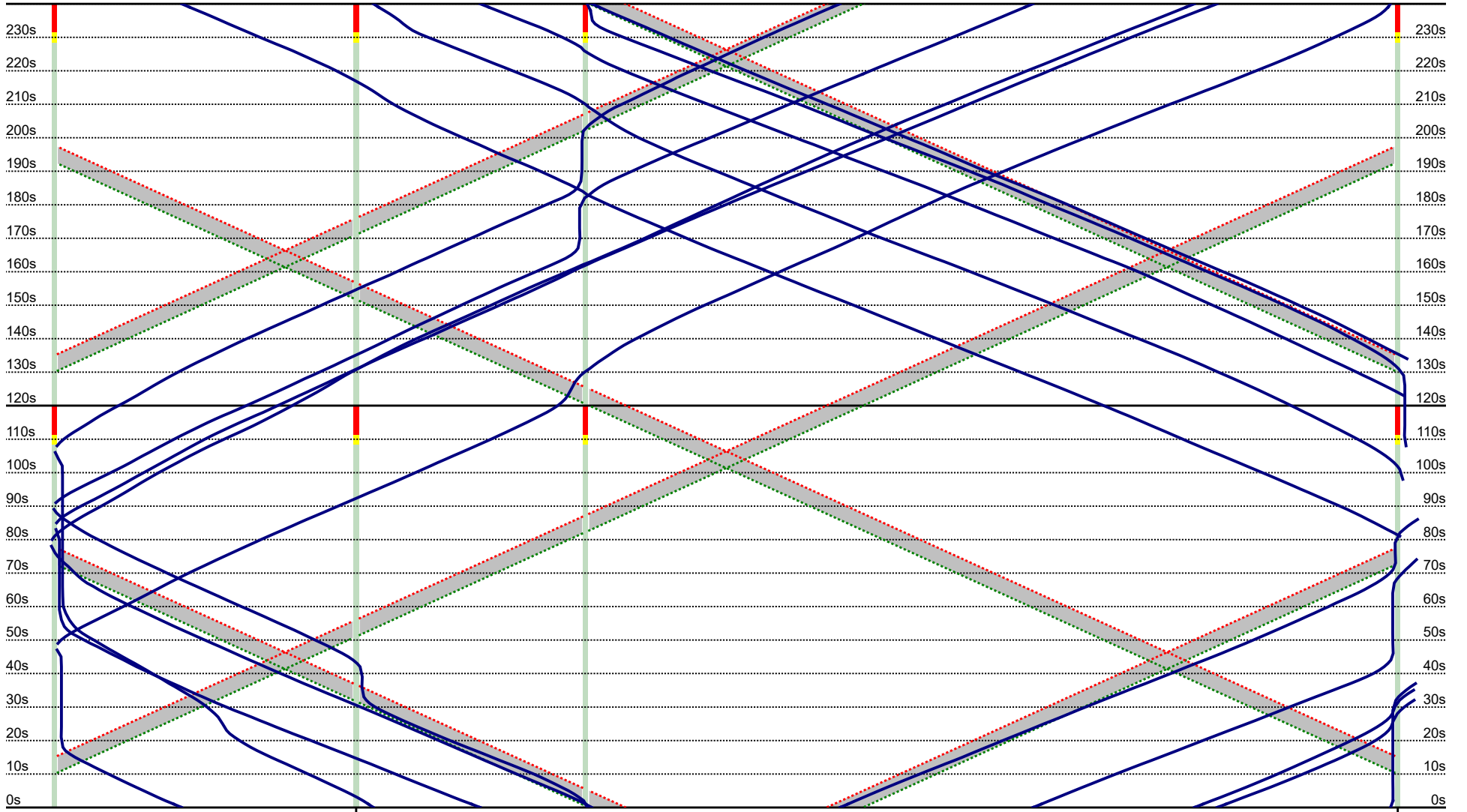

Bowden Rd

Dean Rd

Hogan Rd

2108 ft

1602 ft

5671 ft

Barnes Rd

Travel Time & Delay Report for Parental Homes Road - 12/9/2020

Legend:

Dir:	Summarized Direction of Travel (NB, SB, EB, or WB)
TT:	Summarized Travel Time from previous Node (seconds)
CTT:	Summarized Cumulative Travel Time since beginning of Run (seconds)
TL:	Summarized Travel Distance from previous Node (feet)
CTL:	Summarized Cumulative Travel Distance since beginning of Run (feet)
Delay:	Summarized Delay in Travel Time from previous Node based on user-specified design speed and distance (seconds) = $TT - RT$
CD:	Summarized Cumulative Delay since beginning of Run (seconds) = $CTT - CRT$
RT:	Summarized Running Time from previous Node (seconds) = DL/DS
CRT:	Summarized Cumulative Running Time (seconds) = accumulation of DL/DS since beginning of Run
PLSD:	Summarized Delay in Posted Speed Limit Travel Time from previous Node (seconds) = $TT - DL/PLS$
CPLSD:	Summarized Cumulative Posted Speed Limit Delay since beginning of Run (seconds)
PLRT:	Summarized Posted Speed Limit Running Time, or Travel Time from previous Node if maintaining Posted Speed Limit (seconds) = DL/PLS
CPLRT:	Summarized Cumulative Posted Speed Limit Running Time, or Travel Time since beginning of Run if maintaining Posted Speed Limit (seconds) = accumulation of DL/PLS since beginning of Run
StopD:	Summarized Stopped Delay, or Time spent Waiting in Queue while traveling from previous Node (seconds). The "Stopped Delay" is counted from when the speed drops below 5 mph after exceeding 15 mph until it exceeds 15 mph once again
CStopD:	Summarized Cumulative Stopped Delay since beginning of Run (seconds). The "Stopped Delay" is counted from when the speed drops below 5 mph after exceeding 15 mph until it exceeds 15 mph once again
AS:	Summarized Actual Average Speed from previous Node (mph) = TL/TT
CAS:	Summarized Cumulative Actual Average Speed since beginning of Run (mph) = CTL/CTT
PLS:	Summarized User-specified Posted Speed Limit (mph)
Stops:	Summarized Number of Stops in Travel from previous Node. A "Stop" is counted when the speed drops below 5 mph after exceeding 15 mph
CStops:	Summarized Cumulative number of Stops in Run. A "Stop" is counted when the speed drops below 5 mph after exceeding 15 mph

Travel Time & Delay Report for Parental Homes Road - 12/9/2020

Cumulative Summary of runs Northbound from Bowden Rd

5 Neither-type runs, 5 of unverifiable origin, collected Wednesday 12/9/2020 to Wednesday 12/9/2020, over day(s) Wed, with starting times during 7:06:26 AM to 7:38:54 AM

	CTI	CTL	CD	CRT	CPLSD	CPLRT	CStopD	CAS	CStops
to Hogan Rd									
Average Neither (n=5)	210	9385	28	183	28	183	19	30.8	1.2
Std Dev Neither (n=5)	27	21	27	0	27	0	22	3.7	0.8

Cumulative Summary of runs Southbound from Hogan Rd

5 Neither-type runs, 5 of unverifiable origin, collected Wednesday 12/9/2020 to Wednesday 12/9/2020, over day(s) Wed, with starting times during 7:01:38 AM to 7:35:17 AM

	CTI	CTL	CD	CRT	CPLSD	CPLRT	CStopD	CAS	CStops
to Bowden Rd									
Average Neither (n=5)	227	9820	44	183	44	183	24	29.8	1.4
Std Dev Neither (n=5)	39	991	39	0	39	0	15	3.3	0.5

Cumulative Summary of all runs, either direction through artery

10 Neither-type runs, 10 of unverifiable origin, collected Wednesday 12/9/2020 to Wednesday 12/9/2020, over day(s) Wed, with starting times during 7:04:15 AM to 7:40:41 AM

	CTI	CTL	CD	CRT	CPLSD	CPLRT	CStopD	CAS	CStops
to End of Artery									
Average Neither (n=10)	219	9603	36	183	36	183	21	30.3	1.3
Std Dev Neither (n=10)	33	700	33	0	33	0	18	3.3	0.7
Difference	0	0	0	0	0	0	0	0.0	0.0
Std Dev Difference	0	0	0	0	0	0	0	0.0	0.0
% Difference	N/D	N/D	N/D	N/D	N/D	N/D	N/D	N/D	N/D

Travel Time & Delay Report for Parental Homes Road - 12/9/2020

Summary of runs Northbound from Bowden Rd

5 Neither-type runs, 5 of unverifiable origin, collected Wednesday 12/9/2020 to Wednesday 12/9/2020, over day(s) Wed, with starting times during 7:06:26 AM to 7:38:54 AM

Node	Dir	TI	CTI	IL	CTL	Delay	CD	RT	CRT	PLSD	CPLSD	PLRT	CPLRT	StopD	CStopD	AS	CAS	PLS	Stops	CStops
to Barnes Rd																				
Average Neither (n=5)	NB	51	51	2116	2116	10	10	41	41	10	10	41	41	2	2	28.8	28.8	35	0.2	0.2
Std Dev Neither (n=5)	NB	9	9	19	19	9	9	0	0	9	9	0	0	4	4	4.4	4.4	0	0.4	0.4
to Dean Rd																				
Average Neither (n=5)	NB	41	92	1595	3711	10	20	31	72	10	20	31	72	7	9	27.4	27.9	35	0.6	0.8
Std Dev Neither (n=5)	NB	8	12	3	18	8	12	0	0	8	12	0	0	7	6	5.5	3.6	0	0.5	0.4
to Hogan Rd																				
Average Neither (n=5)	NB	118	210	5675	9385	8	28	110	183	8	28	110	183	10	19	33.2	30.8	35	0.4	1.2
Std Dev Neither (n=5)	NB	18	27	5	21	18	27	0	0	18	27	0	0	18	22	4.3	3.7	0	0.5	0.8

Travel Time & Delay Report for Parental Homes Road - 12/9/2020

Summary of runs Southbound from Hogan Rd

5 Neither-type runs, 5 of unverifiable origin, collected Wednesday 12/9/2020 to Wednesday 12/9/2020, over day(s) Wed, with starting times during 7:01:38 AM to 7:35:17 AM

Node	Dir	TI	CTI	IL	CTL	Delay	CD	RT	CRT	PLSD	CPLSD	PLRT	CPLRT	StopD	CStopD	AS	CAS	PLS	Stops	CStops
to Dean Rd																				
Average Neither (n=5)	SB	110	110	5666	5666	0	0	110	110	0	0	110	110	3	3	35.2	35.2	35	0.2	0.2
Std Dev Neither (n=5)	SB	6	6	5	5	6	6	0	0	6	6	0	0	6	6	2.0	2.0	0	0.4	0.4
to Barnes Rd																				
Average Neither (n=5)	SB	42	152	1607	7273	10	10	31	142	10	10	31	142	8	10	28.1	33.1	35	0.6	0.8
Std Dev Neither (n=5)	SB	12	17	2	6	12	17	0	0	12	17	0	0	7	11	8.1	3.8	0	0.5	0.8
to Bowden Rd																				
Average Neither (n=5)	SB	76	227	2547	9820	35	44	41	183	35	44	41	183	13	24	23.7	29.8	35	0.6	1.4
Std Dev Neither (n=5)	SB	33	39	987	991	33	39	0	0	33	39	0	0	15	15	4.4	3.3	0	0.5	0.5

Travel Time & Delay Report for Parental Homes Road - 12/9/2020

Legend:

Dir:	Summarized Direction of Travel (NB, SB, EB, or WB)
TT:	Summarized Travel Time from previous Node (seconds)
CTT:	Summarized Cumulative Travel Time since beginning of Run (seconds)
TL:	Summarized Travel Distance from previous Node (feet)
CTL:	Summarized Cumulative Travel Distance since beginning of Run (feet)
Delay:	Summarized Delay in Travel Time from previous Node based on user-specified design speed and distance (seconds) = TT - RT
CD:	Summarized Cumulative Delay since beginning of Run (seconds) = CTT - CRT
RT:	Summarized Running Time from previous Node (seconds) = DL/DS
CRT:	Summarized Cumulative Running Time (seconds) = accumulation of DL/DS since beginning of Run
PLSD:	Summarized Delay in Posted Speed Limit Travel Time from previous Node (seconds) = TT - DL/PLS
CPLSD:	Summarized Cumulative Posted Speed Limit Delay since beginning of Run (seconds)
PLRT:	Summarized Posted Speed Limit Running Time, or Travel Time from previous Node if maintaining Posted Speed Limit (seconds) = DL/PLS
CPLRT:	Summarized Cumulative Posted Speed Limit Running Time, or Travel Time since beginning of Run if maintaining Posted Speed Limit (seconds) = accumulation of DL/PLS since beginning of Run
StopD:	Summarized Stopped Delay, or Time spent Waiting in Queue while traveling from previous Node (seconds). The "Stopped Delay" is counted from when the speed drops below 5 mph after exceeding 15 mph until it exceeds 15 mph once again
CStopD:	Summarized Cumulative Stopped Delay since beginning of Run (seconds). The "Stopped Delay" is counted from when the speed drops below 5 mph after exceeding 15 mph until it exceeds 15 mph once again
AS:	Summarized Actual Average Speed from previous Node (mph) = TL/TT
CAS:	Summarized Cumulative Actual Average Speed since beginning of Run (mph) = CTL/CTT
PLS:	Summarized User-specified Posted Speed Limit (mph)
Stops:	Summarized Number of Stops in Travel from previous Node. A "Stop" is counted when the speed drops below 5 mph after exceeding 15 mph
CStops:	Summarized Cumulative number of Stops in Run. A "Stop" is counted when the speed drops below 5 mph after exceeding 15 mph

Travel Time & Delay Report for Parental Homes Road - 12/9/2020

Cumulative Summary of runs Northbound from Bowden Rd

5 Neither-type runs, 5 of unverifiable origin, collected Wednesday 12/9/2020 to Wednesday 12/9/2020, over day(s) Wed, with starting times during 12:26:29 PM to 12:57:30 PM

	CTI	CTL	CD	CRT	CPLSD	CPLRT	CStopD	CAS	CStops
to Hogan Rd									
Average Neither (n=5)	208	9398	25	183	25	183	19	31.0	1.0
Std Dev Neither (n=5)	18	10	18	0	18	0	17	2.7	1.0

Cumulative Summary of runs Southbound from Hogan Rd

5 Neither-type runs, 5 of unverifiable origin, collected Wednesday 12/9/2020 to Wednesday 12/9/2020, over day(s) Wed, with starting times during 12:22:25 PM to 12:54:04 PM

	CTI	CTL	CD	CRT	CPLSD	CPLRT	CStopD	CAS	CStops
to Bowden Rd									
Average Neither (n=5)	206	9377	23	183	23	183	22	31.3	0.8
Std Dev Neither (n=5)	23	21	23	0	23	0	18	3.2	0.4

Cumulative Summary of all runs, either direction through artery

10 Neither-type runs, 10 of unverifiable origin, collected Wednesday 12/9/2020 to Wednesday 12/9/2020, over day(s) Wed, with starting times during 12:24:46 PM to 12:58:53 PM

	CTI	CTL	CD	CRT	CPLSD	CPLRT	CStopD	CAS	CStops
to End of Artery									
Average Neither (n=10)	207	9387	24	183	24	183	20	31.2	0.9
Std Dev Neither (n=10)	19	19	19	0	19	0	17	2.8	0.7
Difference	0	0	0	0	0	0	0	0.0	0.0
Std Dev Difference	0	0	0	0	0	0	0	0.0	0.0
% Difference	N/D	N/D	N/D	N/D	N/D	N/D	N/D	N/D	N/D

Travel Time & Delay Report for Parental Homes Road - 12/9/2020

Summary of runs Northbound from Bowden Rd

5 Neither-type runs, 5 of unverifiable origin, collected Wednesday 12/9/2020 to Wednesday 12/9/2020, over day(s) Wed, with starting times during 12:26:29 PM to 12:57:30 PM

Node	Dir	TI	CTI	IL	CTL	Delay	CD	RT	CRT	PLSD	CPLSD	PLRT	CPLRT	StopD	CStopD	AS	CAS	PLS	Stops	CStops
to Barnes Rd																				
Average Neither (n=5)	NB	48	48	2122	2122	7	7	41	41	7	7	41	41	0	0	30.4	30.4	35	0.0	0.0
Std Dev Neither (n=5)	NB	3	3	13	13	3	3	0	0	3	3	0	0	0	0	1.6	1.6	0	0.0	0.0
to Dean Rd																				
Average Neither (n=5)	NB	39	87	1596	3718	8	15	31	72	8	15	31	72	6	6	28.8	29.3	35	0.4	0.4
Std Dev Neither (n=5)	NB	8	7	2	12	8	7	0	0	8	7	0	0	8	8	5.9	2.4	0	0.5	0.5
to Hogan Rd																				
Average Neither (n=5)	NB	121	208	5680	9398	10	25	110	183	10	25	110	183	13	19	32.4	31.0	35	0.6	1.0
Std Dev Neither (n=5)	NB	15	18	9	10	15	18	0	0	15	18	0	0	14	17	3.7	2.7	0	0.5	1.0

Travel Time & Delay Report for Parental Homes Road - 12/9/2020

Summary of runs Southbound from Hogan Rd

5 Neither-type runs, 5 of unverifiable origin, collected Wednesday 12/9/2020 to Wednesday 12/9/2020, over day(s) Wed, with starting times during 12:22:25 PM to 12:54:04 PM

Node	Dir	TI	CTI	IL	CTL	Delay	CD	RT	CRT	PLSD	CPLSD	PLRT	CPLRT	StopD	CStopD	AS	CAS	PLS	Stops	CStops
to Dean Rd																				
Average Neither (n=5)	SB	105	105	5664	5664	-5	-5	110	110	-5	-5	110	110	0	0	36.8	36.8	35	0.0	0.0
Std Dev Neither (n=5)	SB	4	4	2	2	4	4	0	0	4	4	0	0	0	0	1.2	1.2	0	0.0	0.0
to Barnes Rd																				
Average Neither (n=5)	SB	34	139	1612	7276	2	-3	31	142	2	-3	31	142	2	2	33.3	35.9	35	0.2	0.2
Std Dev Neither (n=5)	SB	5	8	2	2	5	8	0	0	5	8	0	0	4	4	4.7	2.0	0	0.4	0.4
to Bowden Rd																				
Average Neither (n=5)	SB	67	206	2101	9377	26	23	41	183	26	23	41	183	20	22	23.2	31.3	35	0.6	0.8
Std Dev Neither (n=5)	SB	23	23	20	21	23	23	0	0	23	23	0	0	20	18	7.2	3.2	0	0.5	0.4

Travel Time & Delay Report for Parental Homes Road - 12/9/2020

Legend:

Dir:	Summarized Direction of Travel (NB, SB, EB, or WB)
TT:	Summarized Travel Time from previous Node (seconds)
CTT:	Summarized Cumulative Travel Time since beginning of Run (seconds)
TL:	Summarized Travel Distance from previous Node (feet)
CTL:	Summarized Cumulative Travel Distance since beginning of Run (feet)
Delay:	Summarized Delay in Travel Time from previous Node based on user-specified design speed and distance (seconds) = $TT - RT$
CD:	Summarized Cumulative Delay since beginning of Run (seconds) = $CTT - CRT$
RT:	Summarized Running Time from previous Node (seconds) = DL/DS
CRT:	Summarized Cumulative Running Time (seconds) = accumulation of DL/DS since beginning of Run
PLSD:	Summarized Delay in Posted Speed Limit Travel Time from previous Node (seconds) = $TT - DL/PLS$
CPLSD:	Summarized Cumulative Posted Speed Limit Delay since beginning of Run (seconds)
PLRT:	Summarized Posted Speed Limit Running Time, or Travel Time from previous Node if maintaining Posted Speed Limit (seconds) = DL/PLS
CPLRT:	Summarized Cumulative Posted Speed Limit Running Time, or Travel Time since beginning of Run if maintaining Posted Speed Limit (seconds) = accumulation of DL/PLS since beginning of Run
StopD:	Summarized Stopped Delay, or Time spent Waiting in Queue while traveling from previous Node (seconds). The "Stopped Delay" is counted from when the speed drops below 5 mph after exceeding 15 mph until it exceeds 15 mph once again
CStopD:	Summarized Cumulative Stopped Delay since beginning of Run (seconds). The "Stopped Delay" is counted from when the speed drops below 5 mph after exceeding 15 mph until it exceeds 15 mph once again
AS:	Summarized Actual Average Speed from previous Node (mph) = TL/TT
CAS:	Summarized Cumulative Actual Average Speed since beginning of Run (mph) = CTL/CTT
PLS:	Summarized User-specified Posted Speed Limit (mph)
Stops:	Summarized Number of Stops in Travel from previous Node. A "Stop" is counted when the speed drops below 5 mph after exceeding 15 mph
CStops:	Summarized Cumulative number of Stops in Run. A "Stop" is counted when the speed drops below 5 mph after exceeding 15 mph

Travel Time & Delay Report for Parental Homes Road - 12/9/2020

Cumulative Summary of runs Northbound from Bowden Rd

5 Neither-type runs, 5 of unverifiable origin, collected Wednesday 12/9/2020 to Wednesday 12/9/2020, over day(s) Wed, with starting times during 5:17:58 PM to 5:54:45 PM

	CTI	CTL	CD	CRT	CPLSD	CPLRT	CStopD	CAS	CStops
to Hogan Rd									
Average Neither (n=5)	235	9367	53	183	53	183	31	27.2	1.6
Std Dev Neither (n=5)	15	11	15	0	15	0	9	1.8	0.9

Cumulative Summary of runs Southbound from Hogan Rd

5 Neither-type runs, 5 of unverifiable origin, collected Wednesday 12/9/2020 to Wednesday 12/9/2020, over day(s) Wed, with starting times during 5:14:04 PM to 5:50:58 PM

	CTI	CTL	CD	CRT	CPLSD	CPLRT	CStopD	CAS	CStops
to Bowden Rd									
Average Neither (n=5)	243	9372	60	183	60	183	49	26.4	1.6
Std Dev Neither (n=5)	14	19	14	0	14	0	15	1.5	0.5

Cumulative Summary of all runs, either direction through artery

10 Neither-type runs, 10 of unverifiable origin, collected Wednesday 12/9/2020 to Wednesday 12/9/2020, over day(s) Wed, with starting times during 5:16:30 PM to 5:56:30 PM

	CTI	CTL	CD	CRT	CPLSD	CPLRT	CStopD	CAS	CStops
to End of Artery									
Average Neither (n=10)	239	9369	56	183	56	183	40	26.8	1.6
Std Dev Neither (n=10)	14	15	14	0	14	0	15	1.6	0.7
Difference	0	0	0	0	0	0	0	0.0	0.0
Std Dev Difference	0	0	0	0	0	0	0	0.0	0.0
% Difference	N/D	N/D	N/D	N/D	N/D	N/D	N/D	N/D	N/D

Travel Time & Delay Report for Parental Homes Road - 12/9/2020

Summary of runs Northbound from Bowden Rd

5 Neither-type runs, 5 of unverifiable origin, collected Wednesday 12/9/2020 to Wednesday 12/9/2020, over day(s) Wed, with starting times during 5:17:58 PM to 5:54:45 PM

Node	Dir	TI	CTI	IL	CTL	Delay	CD	RT	CRT	PLSD	CPLSD	PLRT	CPLRT	StopD	CStopD	AS	CAS	PLS	Stops	CStops
to Barnes Rd																				
Average Neither (n=5)	NB	53	53	2095	2095	12	12	41	41	12	12	41	41	2	2	27.2	27.2	35	0.4	0.4
Std Dev Neither (n=5)	NB	7	7	2	2	7	7	0	0	7	7	0	0	4	4	3.2	3.2	0	0.5	0.5
to Dean Rd																				
Average Neither (n=5)	NB	36	89	1596	3691	5	17	31	72	5	17	31	72	1	4	30.8	28.6	35	0.2	0.6
Std Dev Neither (n=5)	NB	5	11	2	3	5	11	0	0	5	11	0	0	3	5	4.1	3.3	0	0.4	0.9
to Hogan Rd																				
Average Neither (n=5)	NB	146	235	5675	9367	36	53	110	183	36	53	110	183	27	31	26.6	27.2	35	1.0	1.6
Std Dev Neither (n=5)	NB	12	15	9	11	12	15	0	0	12	15	0	0	11	9	2.2	1.8	0	0.0	0.9

Travel Time & Delay Report for Parental Homes Road - 12/9/2020

Summary of runs Southbound from Hogan Rd

5 Neither-type runs, 5 of unverifiable origin, collected Wednesday 12/9/2020 to Wednesday 12/9/2020, over day(s) Wed, with starting times during 5:14:04 PM to 5:50:58 PM

Node	Dir	TI	CTI	IL	CTL	Delay	CD	RT	CRT	PLSD	CPLSD	PLRT	CPLRT	StopD	CStopD	AS	CAS	PLS	Stops	CStops
to Dean Rd																				
Average Neither (n=5)	SB	116	116	5666	5666	5	5	110	110	5	5	110	110	3	3	33.6	33.6	35	0.2	0.2
Std Dev Neither (n=5)	SB	10	10	6	6	10	10	0	0	10	10	0	0	6	6	2.6	2.6	0	0.4	0.4
to Barnes Rd																				
Average Neither (n=5)	SB	43	158	1607	7273	11	17	31	142	11	17	31	142	7	10	27.1	31.5	35	0.4	0.6
Std Dev Neither (n=5)	SB	12	12	3	5	12	12	0	0	12	12	0	0	11	11	6.6	2.5	0	0.5	0.5
to Bowden Rd																				
Average Neither (n=5)	SB	85	243	2099	9372	43	60	41	183	43	60	41	183	39	49	17.2	26.4	35	1.0	1.6
Std Dev Neither (n=5)	SB	12	14	21	19	12	14	0	0	12	14	0	0	12	15	2.8	1.5	0	0.0	0.5

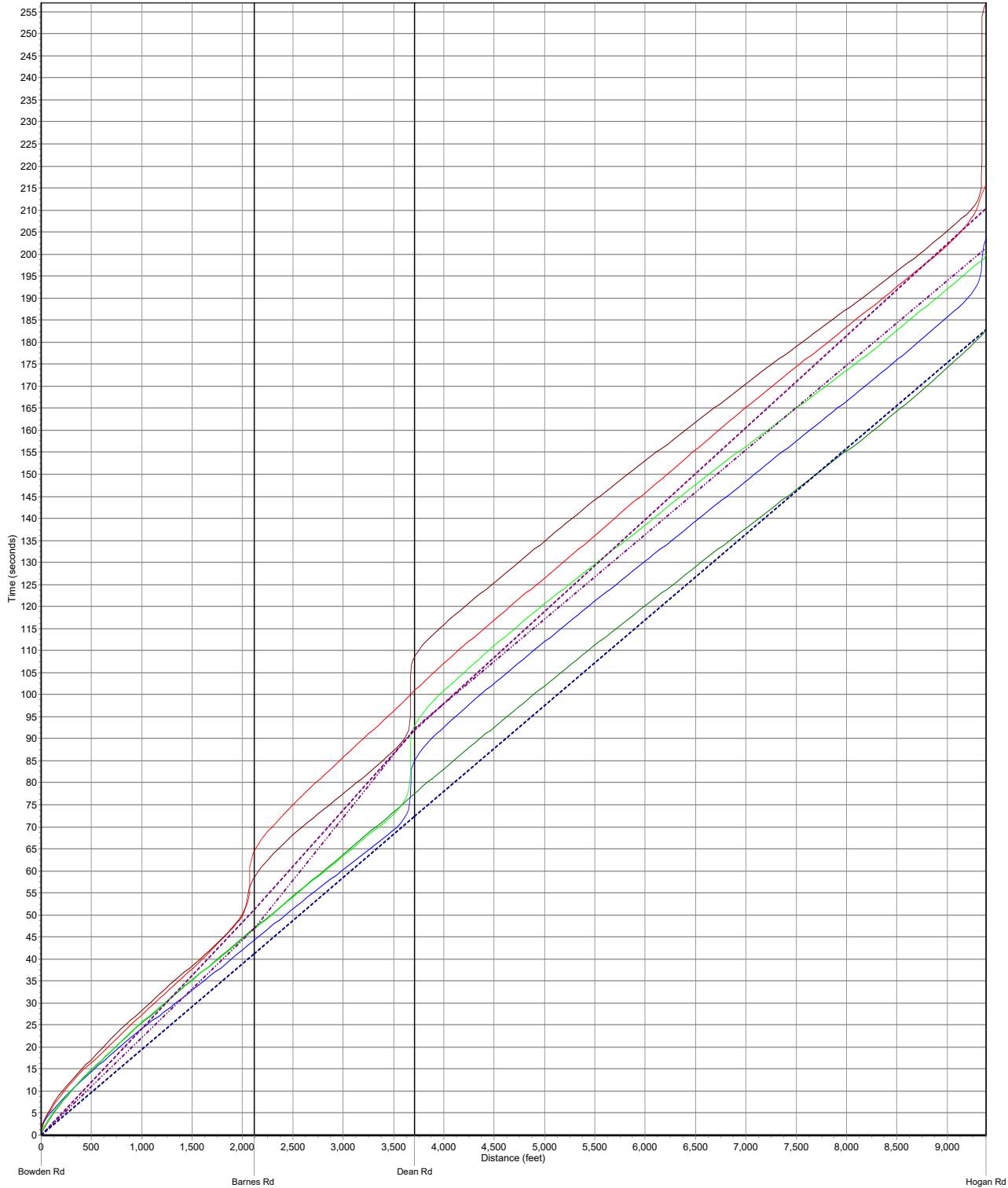

- (imported) <[CDATA[Lat:30.287579, Lon:-81.579186, Ele:-15.301698]]> Run 2 started 7:06 AM 12/9/2020
- (imported) <[CDATA[Lat:30.287579, Lon:-81.579186, Ele:-15.301698]]> Run 4 started 7:13 AM 12/9/2020
- (imported) <[CDATA[Lat:30.287579, Lon:-81.579186, Ele:-15.301698]]> Run 6 started 7:22 AM 12/9/2020
- (imported) <[CDATA[Lat:30.287579, Lon:-81.579186, Ele:-15.301698]]> Run 8 started 7:29 AM 12/9/2020
- (imported) <[CDATA[Lat:30.287579, Lon:-81.579186, Ele:-15.301698]]> Run 10 started 7:38 AM 12/9/2020
- Average Link Time
- Median Link Time
- Posted Time Limit

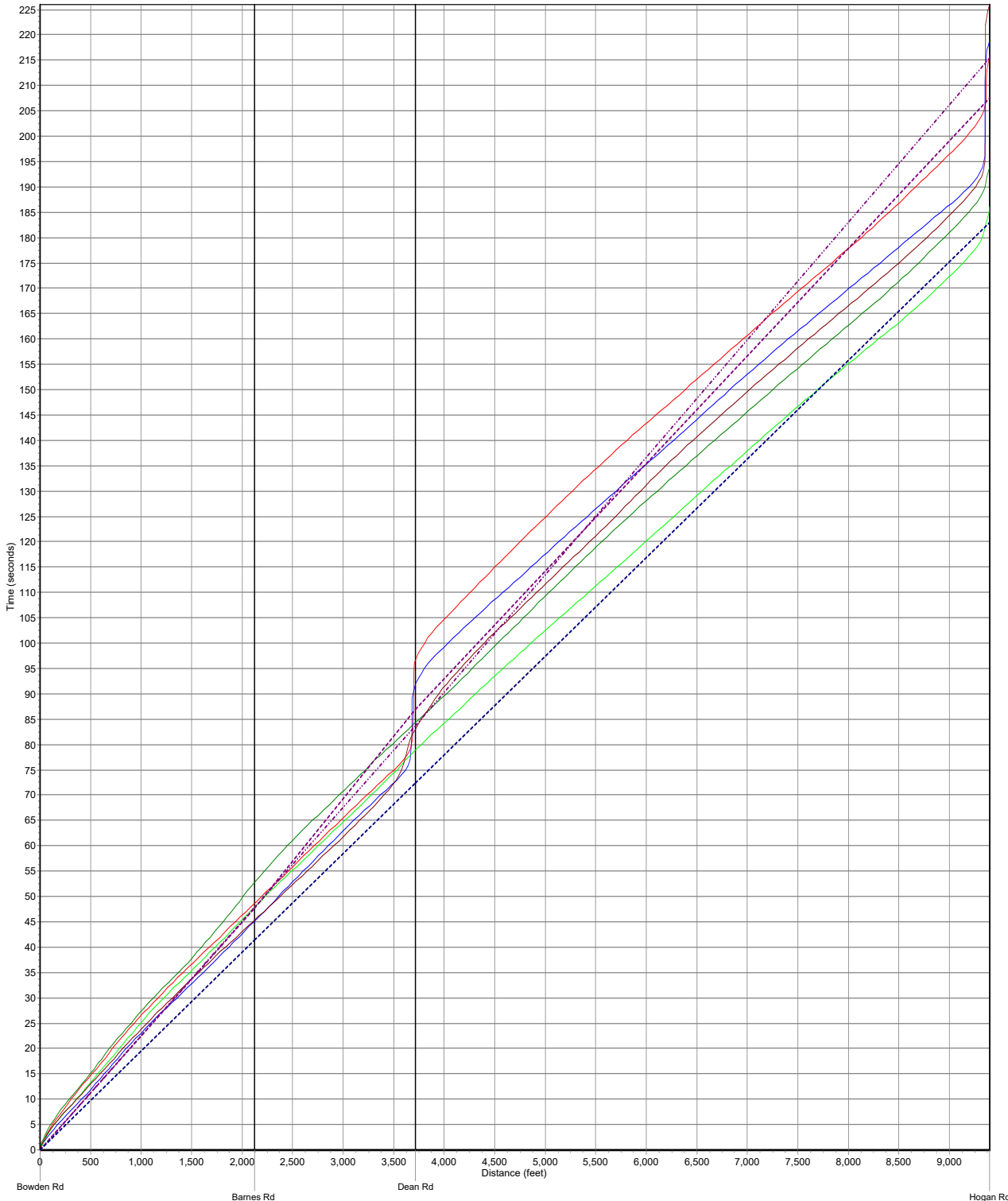

- (imported) <[CDATA[Lat:30.287578, Lon:-81.579050, Ele:-31.590820]]> Run 2 started 12:26 PM 12/9/2020
- (imported) <[CDATA[Lat:30.287578, Lon:-81.579050, Ele:-31.590820]]> Run 4 started 12:34 PM 12/9/2020
- (imported) <[CDATA[Lat:30.287578, Lon:-81.579050, Ele:-31.590820]]> Run 6 started 12:42 PM 12/9/2020
- (imported) <[CDATA[Lat:30.287578, Lon:-81.579050, Ele:-31.590820]]> Run 8 started 12:50 PM 12/9/2020
- (imported) <[CDATA[Lat:30.287578, Lon:-81.579050, Ele:-31.590820]]> Run 10 started 12:57 PM 12/9/2020
- Average Link Time
- Median Link Time
- Posted Time Limit

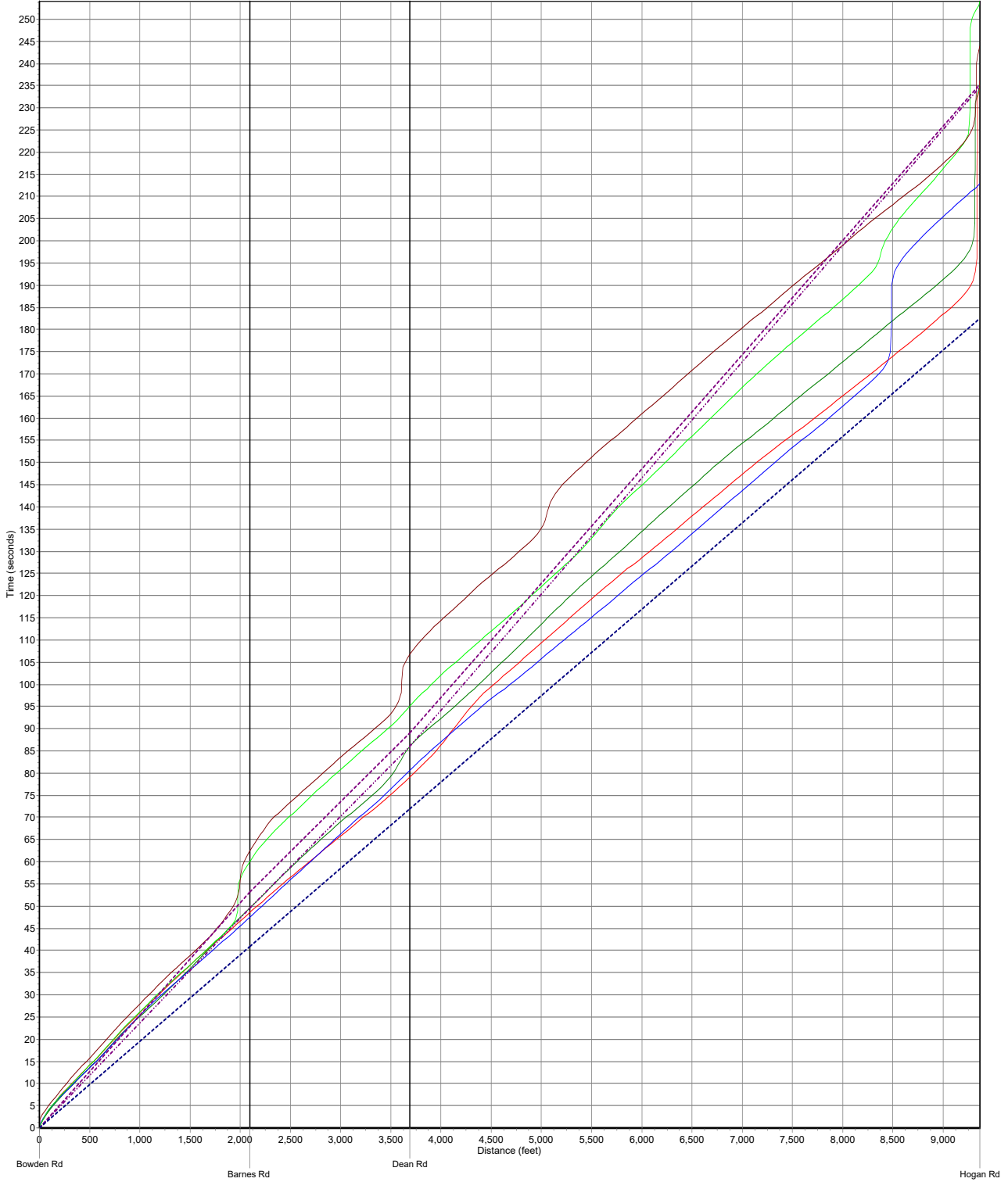

- (imported) <[CDATA[Lat:30.290327, Lon:-81.592611, Ele:-22.588165]]> Run 2 started 5:17 PM 12/9/2020
- (imported) <[CDATA[Lat:30.290327, Lon:-81.592611, Ele:-22.588165]]> Run 4 started 5:27 PM 12/9/2020
- (imported) <[CDATA[Lat:30.290327, Lon:-81.592611, Ele:-22.588165]]> Run 6 started 5:36 PM 12/9/2020
- (imported) <[CDATA[Lat:30.290327, Lon:-81.592611, Ele:-22.588165]]> Run 8 started 5:45 PM 12/9/2020
- (imported) <[CDATA[Lat:30.290327, Lon:-81.592611, Ele:-22.588165]]> Run 10 started 5:54 PM 12/9/2020
- Average Link Time
- Median Link Time
- Posted Time Limit

Appendix D

Survey Results

Q1 Which best describes your use of Parental Home Road?

Answered: 190 Skipped: 6

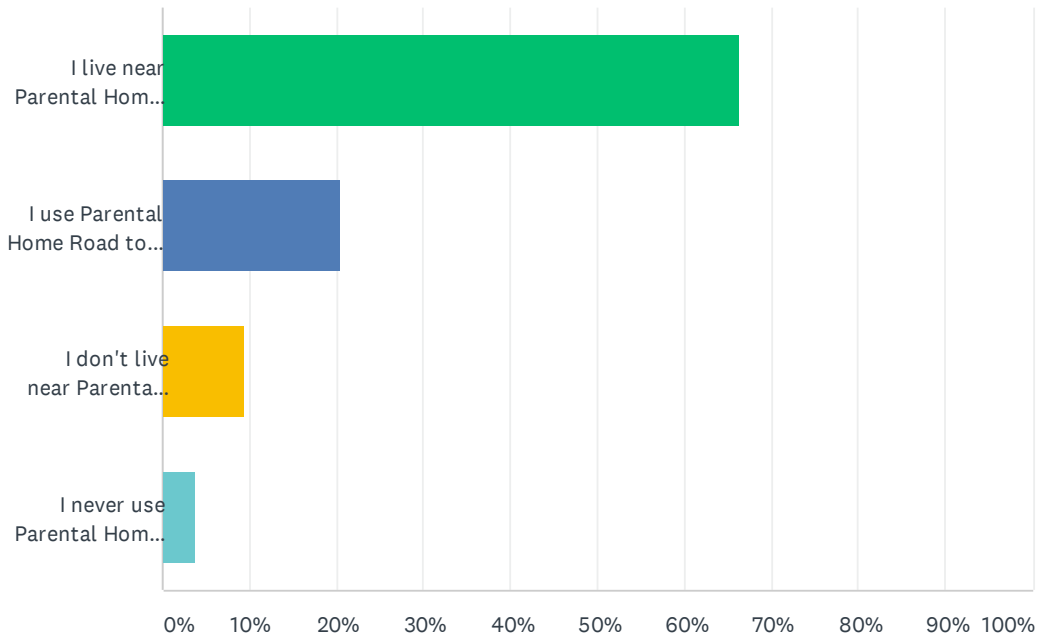

ANSWER CHOICES	RESPONSES	
I live near Parental Home Road and use it to get to many of my destinations.	66.32%	126
I use Parental Home Road to access Beach Boulevard.	20.53%	39
I don't live near Parental Home Road, but I use it to get to work or school.	9.47%	18
I never use Parental Home Road.	3.68%	7
TOTAL		190

Q2 How often do you walk or bike on Parental Home Road?

Answered: 185 Skipped: 11

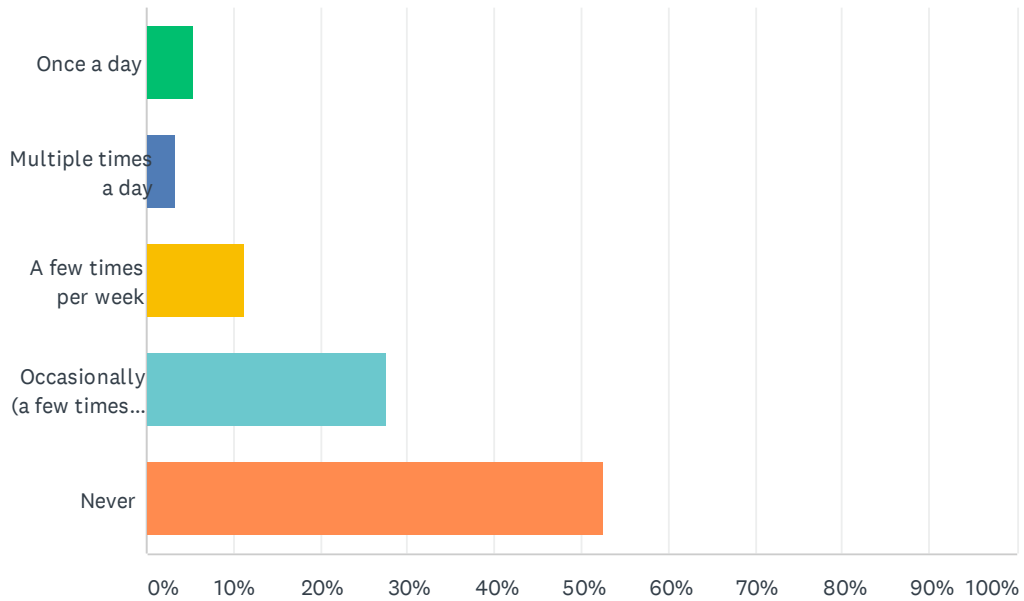

ANSWER CHOICES	RESPONSES	
Once a day	5.41%	10
Multiple times a day	3.24%	6
A few times per week	11.35%	21
Occasionally (a few times a month)	27.57%	51
Never	52.43%	97
TOTAL		185

Q3 What do you think is the best characteristic of Parental Home Road?

Answered: 133 Skipped: 63

#	RESPONSES	DATE
1	Easy access to destinations within the neighborhood	6/7/2021 9:43 PM
2	Needs work	6/7/2021 9:39 PM
3	It's a quiet street with a nice treescape as you drive through.	6/7/2021 9:12 AM
4	Line of site	5/31/2021 2:42 PM
5	It connects me with the main streets that I take to get to my destinations daily.	5/31/2021 1:19 PM
6	Access	5/31/2021 11:35 AM
7	It connects beach Blvd. with hogan and Bowden rd.	5/30/2021 11:10 PM
8	trees	5/30/2021 4:09 PM
9	Drew Park and Liberty Bakery	5/29/2021 10:06 PM
10	none	5/29/2021 4:10 PM
11	Good less traffic short-cut!	5/29/2021 12:16 PM
12	Location	5/29/2021 7:11 AM
13	Connects major corridors	5/28/2021 10:18 PM
14	light traffic usually	5/28/2021 10:14 PM
15	The length	5/28/2021 9:15 PM
16	Trees	5/28/2021 7:22 PM
17	Quiet	5/27/2021 11:53 AM
18	No speed humps	5/26/2021 2:52 AM
19	The quickest way to get to beach blvd	5/25/2021 10:14 AM
20	Country feel	5/24/2021 7:15 AM
21	The trees	5/23/2021 10:44 PM
22	Tree canopy at bowden	5/23/2021 10:40 PM
23	It is a good neighborhood area and a quick way to get where I need to go from where I live.	5/23/2021 9:25 PM
24	Trees and nice residential, parks	5/23/2021 6:42 AM
25	The 'tree tunnel' at the end by Bowden. Please don't remove it! It's a pretty spot.	5/23/2021 5:41 AM
26	The trees are beautiful	5/23/2021 12:36 AM
27	Great connection	5/22/2021 10:02 PM
28	Pld	5/22/2021 8:49 PM
29	The shortcut it provides between Beach and University Blvds.	5/22/2021 6:11 PM
30	Trees	5/22/2021 3:01 PM
31	Trees	5/22/2021 8:48 AM
32	Cut Through	5/22/2021 7:01 AM
33	A mildly busy road at peak times	5/21/2021 11:48 PM

Parental Home Road Survey

34	The lanes when going toward the Beach on Beach were well designed for on/off traffic flow on Parental Home	5/21/2021 11:02 PM
35	Location	5/21/2021 6:36 PM
36	Many neighborhoods with trees.	5/21/2021 5:22 PM
37	Oak trees	5/21/2021 2:00 PM
38	Not sure.	5/21/2021 12:59 PM
39	Nice homes and yards	5/21/2021 11:30 AM
40	Gives you an exposure to a traditional Jacksonville neighborhood	5/20/2021 2:15 PM
41	Nothing	5/20/2021 2:03 PM
42	It connects many neighborhoods with Beach Blvd.	5/20/2021 7:47 AM
43	Access to many main roads	5/20/2021 1:22 AM
44	The trees	5/19/2021 3:41 PM
45	East Road and Parental Home Road are extremely dangerous even with the sidewalks. The speeding is out of control	5/19/2021 8:30 AM
46	I love the little bakery at the corner of Parental and Bowden	5/19/2021 7:58 AM
47	scenic	5/19/2021 7:47 AM
48	Goes through Nice neighborhood	5/18/2021 5:16 PM
49	Trees	5/18/2021 4:16 PM
50	Convenient road to other places	5/18/2021 4:08 PM
51	Nothing needs bike access	5/18/2021 12:58 PM
52	Shade and tree-line road.	5/18/2021 11:58 AM
53	SHADE TREES	5/18/2021 11:07 AM
54	It follows the natural landscape created by the Pottsburg Creek watershed	5/18/2021 11:00 AM
55	nothing	5/18/2021 10:45 AM
56	The feel of a somewhat rural type road. The existing sidewalk and partial pieces. That you can access other areas of town such as South Point, University Blvd, Southside Blvd all while staying off of the major roadways. With the homes, ball park, schools and apartments in the area, there seems to be a substantial amount of pedestrians. Would really like to see it stay at a posted low speed and possibly use traffic calming enhancements at determined high speed or safety area concerns. Thank you.	5/18/2021 10:13 AM
57	The best part for me is the route. There are not good alternate routes with less traffic.	5/18/2021 9:33 AM
58	Sidewalks and parks	5/18/2021 4:23 AM
59	Trees	5/17/2021 12:49 PM
60	It's attractive between Bowden and Barnes. It provides great access between Bowden and Hogan and Beach.	5/17/2021 10:08 AM
61	The Park	5/17/2021 6:24 AM
62	Homey	5/16/2021 8:54 PM
63	The houses, trees, animals, everything. It's a good walks hearing little animals; watching people on porch, doing yard work . But on bad side cars going too fast sometimes don't want to share road with people or bicycles. My husband stop bicycling because he doesn't feel safe. Even walking it's a challenge.	5/16/2021 8:20 PM
64	It's a little slice of rural in the city	5/16/2021 8:00 PM

Parental Home Road Survey

65	It's a nice road or use to be in the 70's and 80's.It could be, but people don't respect it	5/16/2021 12:11 PM
66	nice road.	5/16/2021 11:46 AM
67	A good road	5/16/2021 8:56 AM
68	Connects to/from multiple feeder roads and Beach Blvd.	5/16/2021 7:56 AM
69	Less traffic	5/15/2021 8:18 PM
70	The old trees at the end near Bowden Rd. The Old Oak Trees Are Well Known For Parental Home Road,My Whole Life,56 years now.plus they were there when my mom was born and she's 81.. The Old Oak Trees!!!	5/15/2021 3:49 PM
71	It's long and walkable great for family walks	5/15/2021 11:43 AM
72	Access to Beach Blvd as well as I-95	5/15/2021 7:30 AM
73	Nice drive	5/14/2021 11:20 PM
74	The quint old Florida vibe, the convince of the road.	5/14/2021 10:25 PM
75	It's a neighborhood street not a highway	5/14/2021 8:52 PM
76	Many large trees! It's rural characteristics with many older homes sitting on huge lots.	5/14/2021 6:19 PM
77	I like the fact that it is mostly still 2 lanes from dean to hogan	5/14/2021 5:47 PM
78	It allows access to Beach Blvd for those of us who live between Belfort and Barnes	5/14/2021 5:34 PM
79	busy	5/14/2021 4:51 PM
80	It's access to Bowden Road	5/14/2021 2:19 PM
81	Old neighborhood	5/14/2021 2:09 PM
82	Easy access to Beach, Bowden, and Hogan. Friendly neighbors.	5/14/2021 1:22 PM
83	There isn't much good, except the original widening at the Bowden end. The traffic is bad and travels much faster than the 35 mph speed limit.	5/14/2021 1:03 PM
84	Great road condition	5/14/2021 12:42 PM
85	Love the trees at the end where Bowden Road is	5/14/2021 11:55 AM
86	Not much. It's not safe to walk or bike. Only use it because I live here.	5/14/2021 11:32 AM
87	Beautiful	5/14/2021 11:02 AM
88	Beautiful houses and yards	5/14/2021 10:27 AM
89	Residential, lots of trees.	5/14/2021 10:10 AM
90	Homey	5/14/2021 9:47 AM
91	The beauty of the gorgeous trees and birds and natural feel with wildlife. It's graceful and quite. It gets you away from confusion and is peaceful. Going to places in there are are a pleasure. I access Belfort and Hogan the but use it for Sallisberru and other destinations too. There are old beautiful homes with great huge yards. the mofrom there	5/14/2021 9:39 AM
92	Beauty of the property and homes	5/14/2021 9:36 AM
93	Neighborhood	5/14/2021 9:24 AM
94	The community	5/14/2021 8:38 AM
95	Trees	5/14/2021 7:46 AM
96	It provides access to many roadways	5/14/2021 7:38 AM
97	Historical homes and yards for those of us who grew up there.	5/14/2021 7:36 AM
98	There is hardly ever any traffic	5/14/2021 7:32 AM
99	The trees and medians on the southern end of the road	5/14/2021 7:31 AM

Parental Home Road Survey

100	Easy-to-use diagonal connection from Bowden to Beach.	5/14/2021 7:22 AM
101	The older homes have their own characteristics surrounded by beautiful trees	5/14/2021 7:21 AM
102	Few traffic lights	5/14/2021 7:20 AM
103	Residual neighborhood w/ old growth trees	5/14/2021 7:07 AM
104	?	5/14/2021 6:15 AM
105	A road that people use a a cut through to Bowen road	5/14/2021 5:50 AM
106	Though I live a block away from Parental it is a "cut through" road. It has always been a major road to get from Southside. Even 40 yrs ago I remember cutting through on it. This also its best characteristic.	5/13/2021 11:41 PM
107	Well maintained	5/13/2021 10:42 PM
108	The divider on south end of Parental Home Road with the 100 year old oaks	5/13/2021 9:22 PM
109	Not sure it has a best characteristic anymore.	5/13/2021 8:33 PM
110	It is allows easy access to Beach Blvd.	5/13/2021 7:53 PM
111	Old road. Get rid of the over grown trees.	5/13/2021 7:32 PM
112	Large lots with a lot of family history.	5/13/2021 6:01 PM
113	Way too busy as too many people use it as a cut through just like they use Hogan as a cut through and too many fly way above the speed limit because they don't live here and don't care.	5/13/2021 5:28 PM
114	The trees!	5/13/2021 5:26 PM
115	None	5/13/2021 4:38 PM
116	I like the overall speed of the road however needs to be designed with more bicycle and pedestrian friendly	5/13/2021 2:38 PM
117	Busy	5/13/2021 1:57 PM
118	Clean	5/13/2021 1:08 PM
119	Old neighborhood feel and charm down by the bakery.	5/13/2021 12:37 PM
120	Trees	5/13/2021 11:39 AM
121	The trees at the Bowden end	5/13/2021 11:21 AM
122	Hanzas Ct, new housing development	5/13/2021 10:25 AM
123	The gorgeous trees that arch over the street *especially near the intersection with Bowden).	5/13/2021 9:50 AM
124	It is one of the few remaining things of my childhood going back close to 85 years.	5/13/2021 8:23 AM
125	less traffic than university blvd	5/13/2021 8:17 AM
126	The giant oak trees on the south end	5/13/2021 7:36 AM
127	It's residential feel. Should reroute traffic from I95 to Beach Blvd.	5/13/2021 3:50 AM
128	Tree tunnel of live oaks at the intersection w/Bowden	5/13/2021 12:57 AM
129	Connectivity to beach Boulevard	5/12/2021 9:28 PM
130	Nice residential area that has beautiful trees, parks and homes.	5/12/2021 2:36 PM
131	street and sidewalk	5/10/2021 11:52 AM
132	Two lanes front facing homes	5/10/2021 9:38 AM
133	Trees!	5/4/2021 11:05 AM

Q4 What do you think is the worst characteristic of Parental Home Road?

Answered: 137 Skipped: 59

#	RESPONSES	DATE
1	Trash	6/7/2021 9:44 PM
2	Trash everywhere	6/7/2021 9:39 PM
3	The sidewalks for bicycles are hot garbage and in need of a resurface or grinding to smooth everything out.	6/7/2021 9:12 AM
4	To narrow	5/31/2021 2:43 PM
5	When it is busy, people seem to think it is a highway and do not pay attention to the speed limit. I have even had people pass me but I guess they must be colorblind and cannot see the double yellow line.	5/31/2021 1:19 PM
6	Curve	5/31/2021 11:36 AM
7	No room for bicycles. Traffic travels to fast. Poor narrow sidewalks, in poor condition.	5/30/2021 11:14 PM
8	n/a	5/30/2021 4:09 PM
9	Hogan intersection	5/29/2021 10:06 PM
10	asshole drivers	5/29/2021 4:11 PM
11	Not complete bike lanes	5/29/2021 12:17 PM
12	Safety and speed	5/29/2021 7:11 AM
13	Not smooth	5/28/2021 10:15 PM
14	Cut through	5/28/2021 9:15 PM
15	Sidewalks are in poor shape.	5/28/2021 7:22 PM
16	Weird street arrangement	5/27/2021 11:54 AM
17	None really	5/26/2021 2:52 AM
18	The speed limit is low	5/25/2021 10:15 AM
19	The guys who sit at the end, near beach and beg for money and the sketchy stores right there at the end.	5/24/2021 7:17 AM
20	Trees need to be trimmed more often	5/23/2021 11:21 PM
21	Only two lanes and part has no sidewalk	5/23/2021 10:44 PM
22	Autocentric. Deathtrap for pedestrians, cyclists and children	5/23/2021 10:41 PM
23	It is quite a busy road. It needs better markings and appropriate lanes and sidewalks for bikers and walkers.	5/23/2021 9:26 PM
24	Traffic	5/23/2021 6:42 AM
25	Traffic at the Beach end during rush hour.	5/23/2021 5:48 AM
26	The curve by Dean is dangerous.	5/23/2021 12:37 AM
27	Solitary	5/22/2021 10:03 PM
28	Traffic	5/22/2021 8:49 PM
29	Too undeveloped for the volume and level of current amount of traffic.	5/22/2021 6:13 PM
30	Cut though traffic	5/22/2021 3:01 PM

Parental Home Road Survey

31	Traffic	5/22/2021 8:49 AM
32	Cut through	5/22/2021 7:02 AM
33	Center turn lane is not the whole length of Parental Home	5/22/2021 12:00 AM
34	Drew Park on Parental Rd could use a few upgrades, maybe a bit more security @ night	5/21/2021 11:07 PM
35	People walking through yards on parental home to cut through	5/21/2021 6:36 PM
36	Main road could be cleaned up to be beautified.	5/21/2021 5:22 PM
37	Excessive cut through traffic and speeders	5/21/2021 2:01 PM
38	Tree/shrub blocking view when trying to enter from side street.	5/21/2021 1:11 PM
39	Not wide enough especially at the intersection with Beach Blvd. Especially during rush hour traffic really backs up and when Parental Home becomes wider at the intersection, some drivers are either confused or rude about try to cut over to another lane at the last minute. Also at the intersection with Dean, drivers turning left from Dean and parental Home do not a lot of the time stop where the line is where they are supposed to stop which makes it hard for people turning right from parental Home onto Dean.	5/21/2021 1:02 PM
40	Traffic and stray dogs	5/21/2021 11:31 AM
41	Too narrow	5/20/2021 2:15 PM
42	Potholes	5/20/2021 2:03 PM
43	There is no center passing lane, so things like deliveries and trash pick up cause back ups on the traffic flow.	5/20/2021 7:48 AM
44	The curve at Dean Rd. Coming from Bowden the traffic light is nearly hidden in the curve - have several near rear end hits	5/20/2021 1:26 AM
45	Traffic	5/19/2021 3:42 PM
46	All the speeding. We can't even ride bikes with our children or walk our dogs and feel safe ON THE SIDEWALKS. The speeding is worst on East Rd as everyone seems to use it as a cut through/ speedway	5/19/2021 8:34 AM
47	busy	5/19/2021 7:48 AM
48	Drivers go too fast for two lane road and inconsistent sidewalk condition	5/18/2021 5:17 PM
49	Speeding cars when there are limited sight distances	5/18/2021 4:17 PM
50	Traffic	5/18/2021 12:58 PM
51	Traffic and lack of space for safe walking/biking.	5/18/2021 11:59 AM
52	An large portion of the right-of-way is devoted to exclusive car use. Furthermore, the car-only-portion is designed specifically to allow distracted, temporarily sober, drivers to go as fast as they please. Which, is exactly how drivers use this road. To be a pedestrian using Parental Home Rd is to risk death by car, that is the worst characteristic.	5/18/2021 11:13 AM
53	SPEED	5/18/2021 11:07 AM
54	congested	5/18/2021 10:45 AM
55	The cost of the homes has declined and some are unkept which has attracted less desirable folks/crime. With just a little beatification, I believe the area would be revitalized and desirable in every way.	5/18/2021 10:15 AM
56	Narrow with no shoulder or bicycle facilities.	5/18/2021 9:33 AM
57	Speeders	5/18/2021 4:23 AM
58	Hard to get out of my street with traffic especially in am pm and school time people use this as a cut thru from Phillips hwy to beach blvd	5/17/2021 12:51 PM
59	When I'm running the Mills/San Sago area it is difficult to cross Parental Home to get to the	5/17/2021 10:10 AM

Parental Home Road Survey

	sidewalk when there is traffic. People drive too fast and in some places visibility is limited.	
60	Single lane	5/17/2021 6:24 AM
61	The intersection of PHR and Dean Road	5/16/2021 8:55 PM
62	Trash all over the road. Some people don't have proud where they live. See people throw trash from cars.	5/16/2021 8:22 PM
63	Cars speed to use as a cuthrough to breach blvd. don't feel safe walking down the road seen to many accidents	5/16/2021 8:08 PM
64	So narrow	5/16/2021 8:00 PM
65	Speeding, careless drivers	5/16/2021 12:11 PM
66	Two lanes	5/16/2021 8:56 AM
67	People driving too fast	5/16/2021 8:34 AM
68	I think it's about as good as it gets. Every member of my family have been using P.H.R. since we moved here in 1950.	5/16/2021 7:57 AM
69	People speeding down this road.	5/16/2021 6:22 AM
70	Too slow	5/15/2021 8:18 PM
71	People Speeding And using as a cute thru...	5/15/2021 3:50 PM
72	Too narrow!!!	5/15/2021 3:13 PM
73	Need better sidewalks	5/15/2021 11:43 AM
74	People speeding	5/15/2021 7:30 AM
75	During rush hour the congestion and the speeding. Often near the two schools and parks cars far exceeding the speed limit	5/14/2021 10:27 PM
76	Sometimes its pretty busy. At one time, there were no sidewalks. I think thats been resolved a lot though.	5/14/2021 8:53 PM
77	None come to mind.	5/14/2021 6:21 PM
78	Race track and big trucking cut thru from Bowden to beach	5/14/2021 5:48 PM
79	The curve by Dean Road	5/14/2021 5:34 PM
80	traffic light takes too long	5/14/2021 4:53 PM
81	How fast people drive on it	5/14/2021 2:20 PM
82	Too much traffic. Speeding.	5/14/2021 2:10 PM
83	People drive much too fast, well over 35mph. It's loud and very busy. I don't feel safe to walk on the sidewalks. It very much needs to be widened between Dean Rd and Hogan Rd.	5/14/2021 1:24 PM
84	The worst is the amount and speed of the traffic. You take your life in your hands to attempt to cross the street.	5/14/2021 1:05 PM
85	Nothing	5/14/2021 12:42 PM
86	Having to wait to get out on Parental when you are coming out from a side road	5/14/2021 11:55 AM
87	It's not safe to walk or bike. Needs a center turn lane so traffic is not backed up during peak travel times.	5/14/2021 11:32 AM
88	Traffic	5/14/2021 11:02 AM
89	There is no passing allowed.	5/14/2021 11:00 AM
90	Speeding cars	5/14/2021 10:42 AM
91	Traffic	5/14/2021 10:28 AM
92	Cut through traffic. Semis using road for cut through.	5/14/2021 10:10 AM

Parental Home Road Survey

93	Don't know of any	5/14/2021 10:05 AM
94	Old looking	5/14/2021 9:47 AM
95	The litter at family dollar.	5/14/2021 9:40 AM
96	Speeding traffic	5/14/2021 9:36 AM
97	Traffic and spending	5/14/2021 9:24 AM
98	Speeding from people that don't live here creates a dangerous environment exacerbated by a lack of light at night. Just like with Ryar Rd which has a sharp 90 degree turn where the name changes to Harvin.	5/14/2021 8:38 AM
99	People speeding	5/14/2021 8:32 AM
100	Racing cars. Cars driving too fast	5/14/2021 7:37 AM
101	Commercial blight proliferation near Beach and Hogan.	5/14/2021 7:32 AM
102	Nothing	5/14/2021 7:22 AM
103	The litter strewn on the sides of the roads	5/14/2021 7:22 AM
104	Not enough sidewalks	5/14/2021 7:21 AM
105	Narrow 2 Lane Rd. Needs street edge marking highlighted for night driving	5/14/2021 7:10 AM
106	Super busy, always backed up with traffic, residents have a hard time getting in and out of their driveway	5/14/2021 7:02 AM
107	?	5/14/2021 6:15 AM
108	Too much traffic, too many trucks	5/14/2021 5:50 AM
109	The traffic of cars cutting down this road. By the shear numbers	5/13/2021 11:41 PM
110	Too much speeding	5/13/2021 10:42 PM
111	Excessive speed of cut through traffic (speed limit 35)	5/13/2021 9:24 PM
112	Lack of sidewalks and bike paths.	5/13/2021 8:34 PM
113	The paving	5/13/2021 7:32 PM
114	Cut through Traffic.	5/13/2021 6:02 PM
115	Speeders as it is hard to pull out or turn off of without getting hit. Riding a bike or walking is way too dangerous.	5/13/2021 5:28 PM
116	Lack of sidewalks in some sections, open drainage ditches	5/13/2021 5:27 PM
117	Too dark, bad sidewalks	5/13/2021 4:38 PM
118	Side walls needed	5/13/2021 1:57 PM
119	No sidewalk on the other side and not enough street lights	5/13/2021 1:09 PM
120	very busy	5/13/2021 12:43 PM
121	Trash, and speeding	5/13/2021 12:37 PM
122	Poor side walks uneven. Heavy traffic with speeding	5/13/2021 11:40 AM
123	people coming off Beach BLVD and trying to cross the Parental Home turn lanes to get into The Dollar General	5/13/2021 11:23 AM
124	Not enough street lamps, overhanging foliage onto sidewalks	5/13/2021 10:47 AM
125	It's a cut through road, and not very well taken care of in appearance	5/13/2021 10:26 AM
126	I like that there's a sidewalk along the road, but I wish it went ALL the way to Beach Blvd.	5/13/2021 9:51 AM
127	Parks	5/13/2021 8:34 AM

Parental Home Road Survey

128	none	5/13/2021 8:17 AM
129	Increase in traffic due to RCSA	5/13/2021 7:37 AM
130	All the traffic from I95	5/13/2021 3:50 AM
131	Skinny for the amount of traffic it takes	5/13/2021 12:58 AM
132	Nothing	5/12/2021 9:29 PM
133	Traffic	5/12/2021 9:13 PM
134	Drivers dont follow the speed limit	5/12/2021 2:37 PM
135	speeding cars	5/10/2021 11:52 AM
136	People want to change it	5/10/2021 9:38 AM
137	...	5/4/2021 11:05 AM

Q5 How often do you use Parental Home Road?

Answered: 164 Skipped: 32

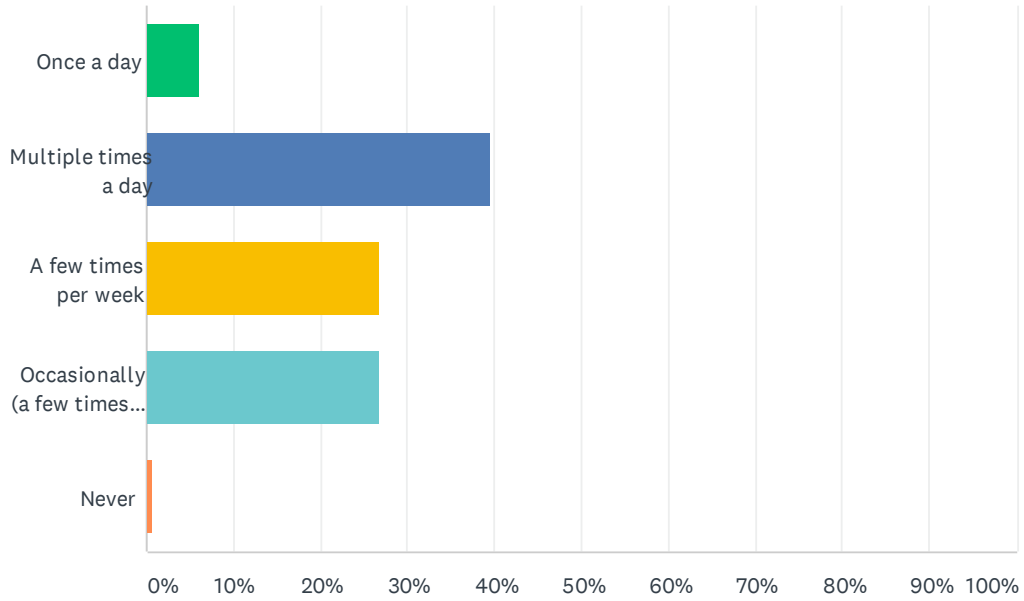

ANSWER CHOICES	RESPONSES	
Once a day	6.10%	10
Multiple times a day	39.63%	65
A few times per week	26.83%	44
Occasionally (a few times a month)	26.83%	44
Never	0.61%	1
TOTAL		164

Q6 What form of transportation do you use most often when you travel along Parental Home Road?

Answered: 165 Skipped: 31

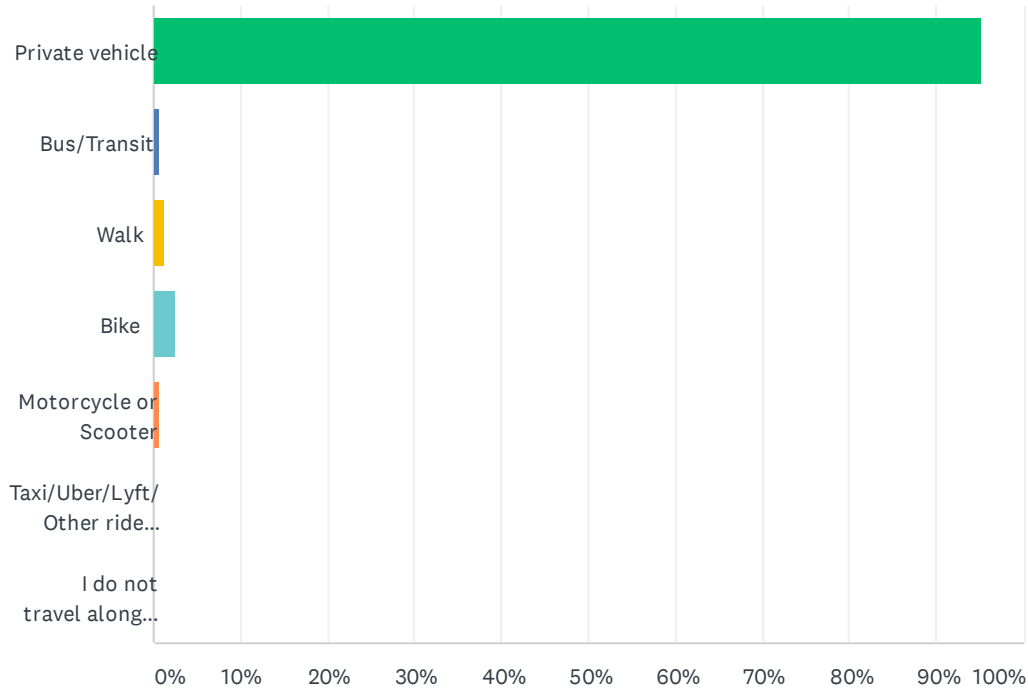

ANSWER CHOICES	RESPONSES	
Private vehicle	95.15%	157
Bus/Transit	0.61%	1
Walk	1.21%	2
Bike	2.42%	4
Motorcycle or Scooter	0.61%	1
Taxi/Uber/Lyft/Other ride share	0.00%	0
I do not travel along Parental Home Road.	0.00%	0
TOTAL		165

Q7 Please rank the importance of the following transportation problems on Parental Home Road with 1 being the most important and 5 being the least important.

Answered: 140 Skipped: 56

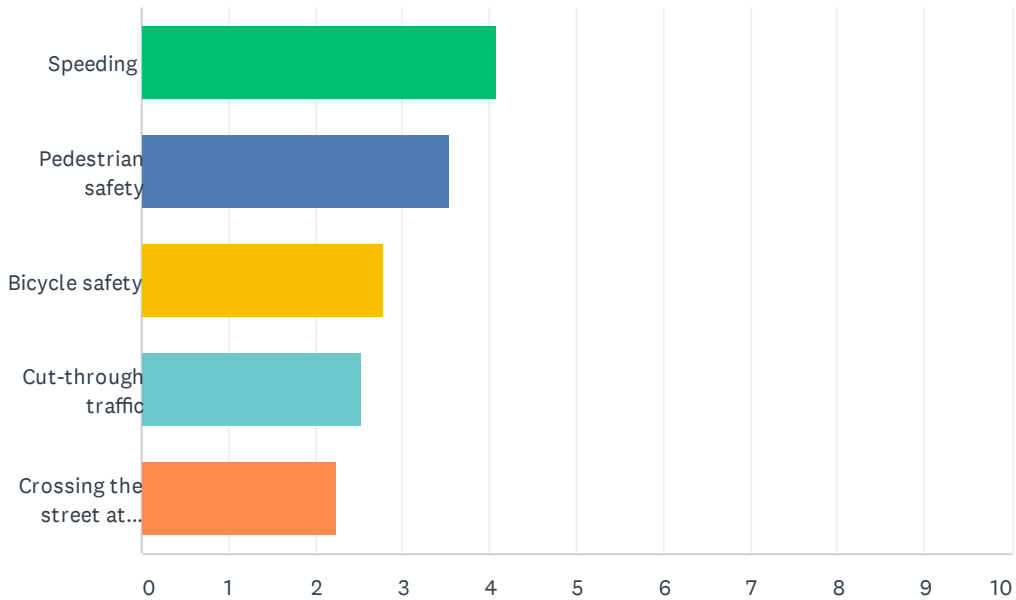

	1	2	3	4	5	TOTAL	SCORE
Speeding	57.89% 77	15.04% 20	12.78% 17	6.02% 8	8.27% 11	133	4.08
Pedestrian safety	14.39% 19	46.21% 61	21.21% 28	14.39% 19	3.79% 5	132	3.53
Bicycle safety	8.76% 12	16.79% 23	37.23% 51	18.98% 26	18.25% 25	137	2.79
Cut-through traffic	12.69% 17	17.91% 24	11.19% 15	26.87% 36	31.34% 42	134	2.54
Crossing the street at non-intersection locations	8.96% 12	7.46% 10	17.16% 23	30.60% 41	35.82% 48	134	2.23

Q8 Would you support traffic calming projects such as narrowing travel lanes and/or raised or painted crosswalks?

Answered: 140 Skipped: 56

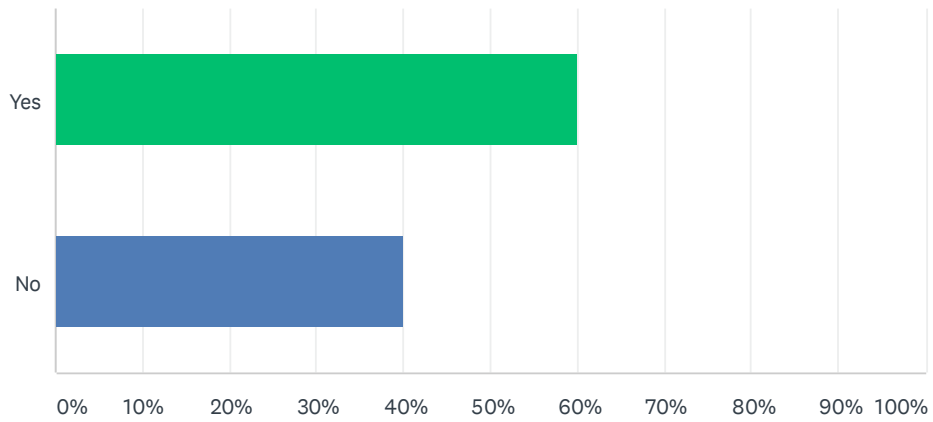

ANSWER CHOICES	RESPONSES	
Yes	60.00%	84
No	40.00%	56
TOTAL		140

Q9 You indicated you would support traffic calming projects. Please rank the following traffic calming projects with 1 being the most important and 4 being the least important.

Answered: 79 Skipped: 117

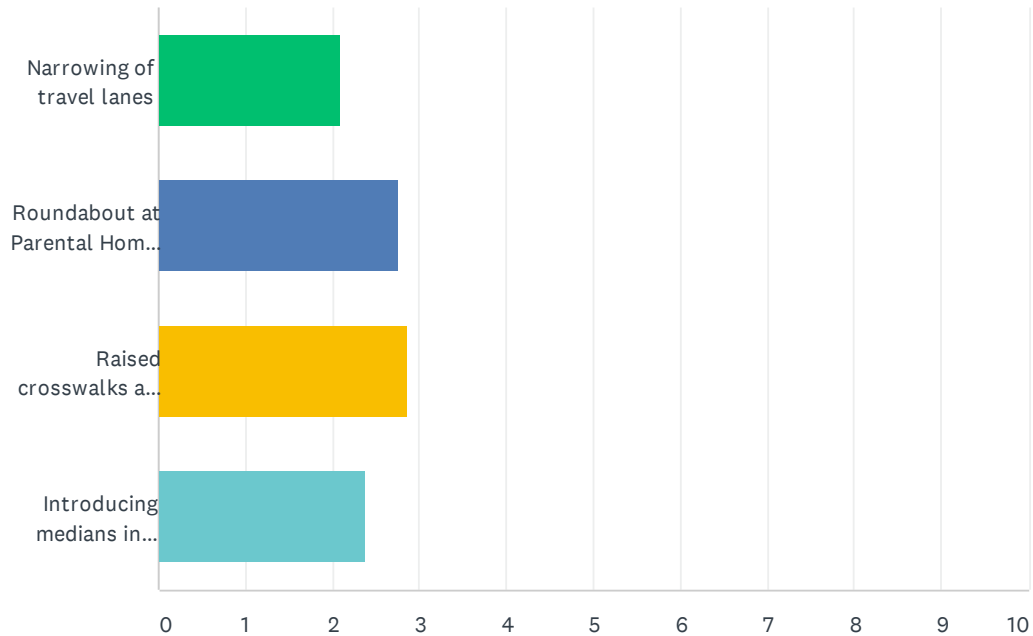

	1	2	3	4	TOTAL	SCORE
Narrowing of travel lanes	17.33% 13	14.67% 11	28.00% 21	40.00% 30	75	2.09
Roundabout at Parental Home Road and Dean Road	37.33% 28	22.67% 17	18.67% 14	21.33% 16	75	2.76
Raised crosswalks at limited locations	35.53% 27	26.32% 20	26.32% 20	11.84% 9	76	2.86
Introducing medians in limited locations	14.47% 11	34.21% 26	27.63% 21	23.68% 18	76	2.39

Q10 You indicated you would not support traffic calming projects. Please explain why.

Answered: 55 Skipped: 141

#	RESPONSES	DATE
1	I just don't think it would make a difference and I would not want to see the roadway narrowed.	5/31/2021 1:22 PM
2	I support the raised crosswalk but not narrowing the lanes. It already feels dangerous if a mail truck or other car is stopped along the road.	5/29/2021 10:09 PM
3	Cars speed over the raised sections of Dean Rd, I don't think the help. Therefore we shouldn't spend money on it	5/28/2021 10:19 PM
4	Peach Drive 2.0 would be such a treat, right.	5/28/2021 7:27 PM
5	Because that would effect traffic on the road	5/26/2021 2:53 AM
6	I am the traffic and I don't want to be calmed	5/25/2021 10:16 AM
7	Narrowing the travel lines would only make things worse. As mentioned, part of this road has no sidewalks.	5/23/2021 10:46 PM
8	The road is narrow enough	5/22/2021 3:04 PM
9	Traffic is only heavy during peak times	5/22/2021 12:17 AM
10	I just don't see enough of a need. Traffic is ok most of the time. May get backed up @ the school/park a bit. Nothing major	5/21/2021 11:11 PM
11	It works	5/21/2021 9:31 PM
12	Neither sound helpful.	5/21/2021 8:17 PM
13	Speed bumps are annoying and we don't need lanes narrowing	5/21/2021 6:38 PM
14	They don't work. I see people that refused to walk a few extra steps to go to a crosswalk and continue to walk in the middle of the road also bicycles do not a lot of the time follow the rules of the road either.	5/21/2021 1:05 PM
15	They are generally avoided and not achieve the intended purpose	5/20/2021 2:18 PM
16	You need to replace this road.	5/20/2021 2:04 PM
17	I personally do not use them. I would support clearly marked pedestrian crossing locations, but narrowing of driving lanes increases traffic congestion.	5/20/2021 7:52 AM
18	not sure they work	5/19/2021 7:50 AM
19	They are narrow enough now	5/18/2021 1:15 PM
20	I live on this street. I don't believe narrowing the lanes would slow down speeders.	5/18/2021 4:26 AM
21	They don't seem to work in Jacksonville. No one except me slows down for the apeed humps on Dean Road.	5/16/2021 8:58 PM
22	I don't suppose narrow roads because that can increase accidents	5/16/2021 8:26 PM
23	The two lanes are too narrow already	5/16/2021 8:02 PM
24	Narrowing???? Dangerous	5/16/2021 12:14 PM
25	the traffic bumps - aka speed bumps - are annoying, hurt cars and cause all sorts of problems	5/16/2021 11:49 AM
26	Damage to my vehicle. Turns a nice drive into a f'in nightmare dodging the unnecessary obstructions.	5/16/2021 8:01 AM

Parental Home Road Survey

27	The road is already narrow enough. Narrow it anymore and it will be a single lane road. I can't think of any benefits to painting the sidewalk, this would be a waste of money.	5/16/2021 6:25 AM
28	Our police officers can set up there speed traps like they use to do. They could get a month's worth of tickets in two or three days,plus DUI's,No Driver License,etc. The officers just need to set up with radars on..	5/15/2021 3:57 PM
29	Destructive to vehicle	5/15/2021 7:31 AM
30	The road is narrow enough. There is a lot of through traffic on the road. I dont see *excessive* speeding as being a problem. "Traffic calming" would turn PHR into a traffic jam from Dean to Beach.	5/14/2021 8:59 PM
31	They need to put officer's to work not put stuff out that tears people's car up. I do understand Y if speeding is an issue but police need to give tickets. To slow the traffic.	5/14/2021 6:48 PM
32	I'm not sure speeders and truck drivers would be affected by narrow lanes or pedestrian crossings	5/14/2021 5:51 PM
33	who wants narrow streets	5/14/2021 4:55 PM
34	Unnecessary.	5/14/2021 2:12 PM
35	Speed bumps are useless and tear up cars	5/14/2021 12:44 PM
36	No speed bumps	5/14/2021 11:58 AM
37	We don't need speed bumps. We need safer access for pedestrians and wider (center turn lane) on the section from Hogan to the curve.	5/14/2021 11:35 AM
38	I see no reason for them. I drive on the road and the lanes are already narrow. I do not want to drive over raised areas that are not good for my vehicle, even at a speed of 35mph and I do not want to see a lower speed limit on a through street.	5/14/2021 11:06 AM
39	No speedbumps like peach drive!!	5/14/2021 10:12 AM
40	In my experience, those "solutions " do not slow traffic and are visually unattractive. Continuous enforcement of existing traffic regulations would provide more immediate relief (by discouraging the offensive behavior and raising funds through traffic fines). Additionally, the use of traffic circles at major intersections would improve traffic flow and ease congestion.	5/14/2021 7:42 AM
41	Lane narrowing doesn't seem calming and raised crosswalks (speed bumps) oftentimes is more frustrating because people will speed between the speed bumps. I've lived in other neighborhoods where this was the case and eventually they were removed.	5/14/2021 7:28 AM
42	The road is narrow enough and speed bumps are annoying	5/14/2021 7:24 AM
43	I would support speed humps but not narrowing the traffic lanes because the lanes are already pretty narrow	5/14/2021 7:04 AM
44	Narrowing lanes doesn't reduce traffic - it just increases it. Pedestrians don't follow painted cross walk lines as it is, adding more won't help fix the problem.	5/14/2021 6:48 AM
45	Because I live on East Road, which is 100% residential and runa paralell to Parental Home Road. These efforts will push even MORE cut through traffic on to East Road, which is already becoming a HUGE problem since the City decided to open a school and a DMV on Hogan Road. East Road needs traffic calming measures.	5/14/2021 5:53 AM
46	Not necessary	5/13/2021 10:44 PM
47	Road is already relatively narrow & I see very few persons trying to cross the road except where there are already traffic lights.	5/13/2021 8:01 PM
48	Leave things alone	5/13/2021 7:34 PM
49	You need to fix the reason people cut through there and Hogan and then start handing out speeding tickets like free candy as they would fix the problems with all the traffic flying down that road.	5/13/2021 5:31 PM
50	More narrow lanes is not feasible. It's too busy of a street to promote bicycle riding.	5/13/2021 12:46 PM
51	Travel lanes do not need narrowed and you are an idiot if you think they do. There are	5/13/2021 11:26 AM

Parental Home Road Survey

	sidewalks the length of the road, there is no need for bicycle lanes	
52	Traffic calming was installed on Peach/Forest and it's awful. Can't maintain the speed limit and very hard on vehicles.	5/13/2021 7:40 AM
53	Need to better understand solutions	5/13/2021 3:52 AM
54	Narrowing an already narrow road w/deep ditches on the side sounds even more dangerous than what already exists. I wouldn't be totally opposed to raised speed bumps (similar to Dean Rd). An additional light somewhere would probably slow people down as well.	5/13/2021 1:02 AM
55	Inconvenience to getting where I need to go without speed tables etc	5/12/2021 9:15 PM

Q11 Would you support additional bicycle facilities along Parental Home Road? (This may include adding a paved shoulder or a dedicated bicycle lane.)

Answered: 134 Skipped: 62

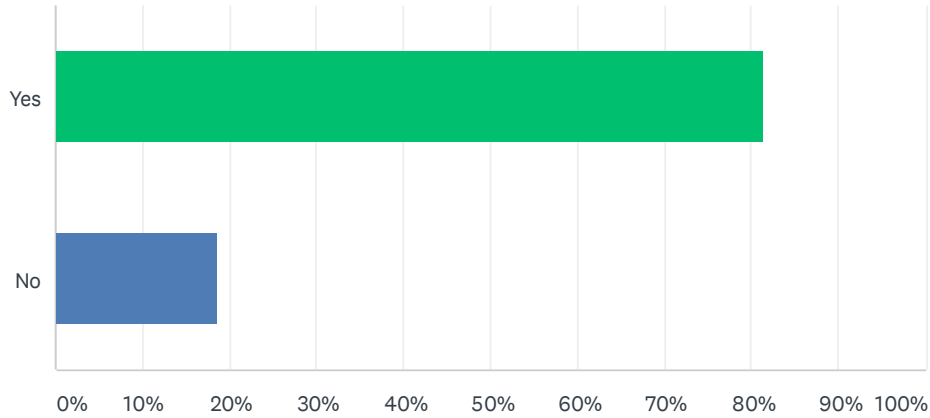

ANSWER CHOICES	RESPONSES	
Yes	81.34%	109
No	18.66%	25
TOTAL		134

Q12 Would you prefer to see on-road or separated facilities?

Answered: 104 Skipped: 92

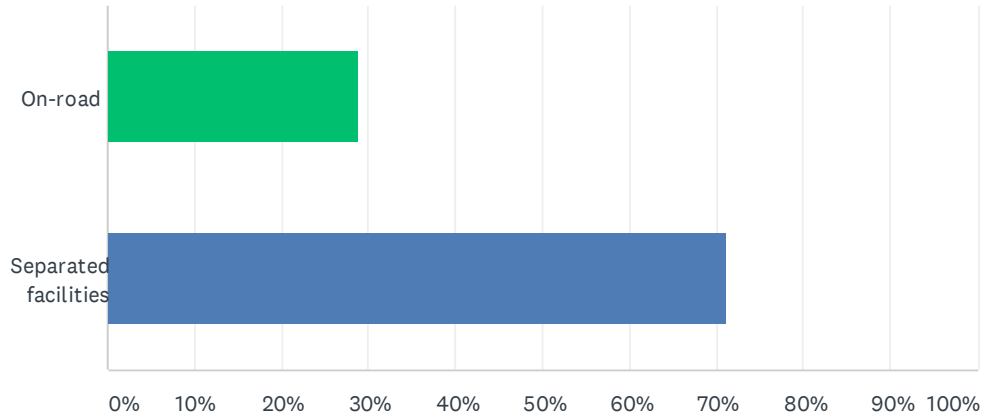

ANSWER CHOICES	RESPONSES
On-road	28.85% 30
Separated facilities	71.15% 74
TOTAL	104

Q13 Would you support additional pedestrian facilities along Parental Home Road? (This may include a 6-foot sidewalk or a 12-foot multi-use path.)

Answered: 130 Skipped: 66

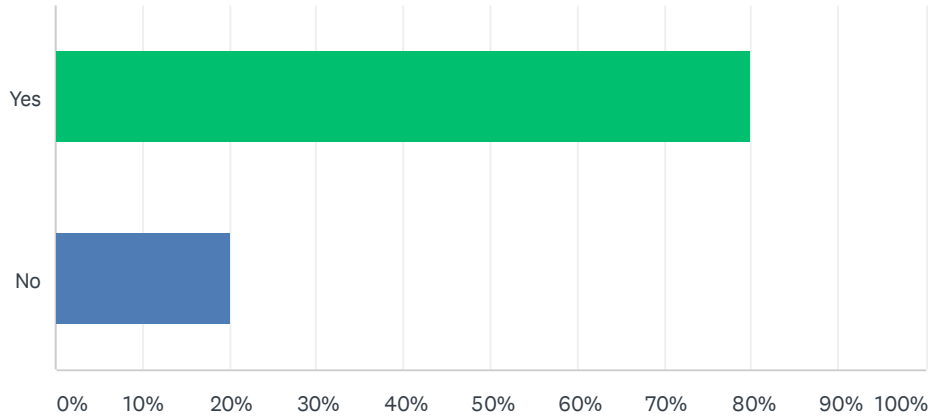

ANSWER CHOICES	RESPONSES	
Yes	80.00%	104
No	20.00%	26
TOTAL		130

Q14 Would you support additional lighting along Parental Home Road to better light the roadway and sidewalks?

Answered: 129 Skipped: 67

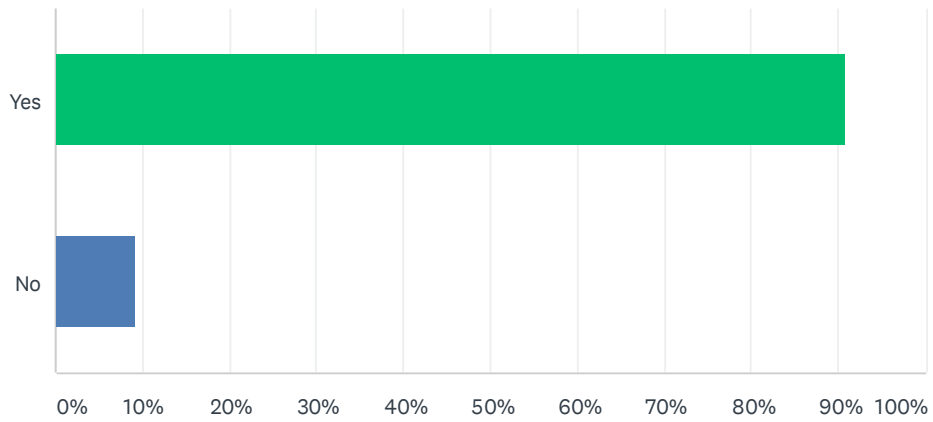

ANSWER CHOICES	RESPONSES	
Yes	90.70%	117
No	9.30%	12
TOTAL		129

Q15 If you would like to provide any additional feedback for the project team, please do so below.

Answered: 49 Skipped: 147

#	RESPONSES	DATE
1	If you widen the road for bike lanes you will need to put in storm sewer	5/31/2021 2:48 PM
2	N/a	5/29/2021 10:10 PM
3	THis a high bike areaandneeds facilities	5/29/2021 4:15 PM
4	Appreciate opportunity to give input.	5/29/2021 7:14 AM
5	Thank you for working to make this area safer!!	5/23/2021 9:30 PM
6	No roundabouts	5/23/2021 6:46 AM
7	I do not think a roundabout at Parental and Dean is a good idea. That is a dangerous intersection already even though there is a traffic light there.	5/23/2021 12:41 AM
8	We have a lot of foot and bicycle traffic from Barnes Rd to Beach Blvd. This should be the starting point for upgrades.	5/22/2021 12:20 AM
9	Cars speed around the corner at dean and parental home and have hit my mailbox and other trees multiple times. Pedestrians and bikes do not need to be in the road with cars.	5/21/2021 6:40 PM
10	Stop the semi trucks from traveling on road	5/21/2021 11:33 AM
11	Repave it first. Don't waste money on the rest.	5/20/2021 2:05 PM
12	we have seen cars turning onto Parental Home (from Bowden headed east) turn to the wrong side of the median (against one way traffic)	5/19/2021 8:16 AM
13	Dedicated bicycle and pedestrian facilities must include physical protection, please.	5/18/2021 11:33 AM
14	used to live across from parental home road and bike to work that way. very dangerous. they need a turn signal light at beach too. can't believe a school is there kids cross over that!	5/18/2021 11:19 AM
15	I have lived on this road for 20 years. Years ago motorcycle police would sit and catch speeders. That ended and the speeding got worse. The road is more dangerous than ever.	5/18/2021 4:30 AM
16	The bushes at Emily Ln on parental heading to Lofberg dr when over grown make it dangerous to get on parental you can't see the traffic coming without moving out into the lane	5/17/2021 12:57 PM
17	Educated people to share the road and slow down. This road already have sidewalks can be use for walks and bicycles that's why I said I don't support because already exist.	5/16/2021 8:28 PM
18	Safety for all, is !its important. Thank you.	5/16/2021 9:00 AM
19	Definitely need better lighting along much of this road. Better control over speeders that doesn't involve putting in speed bumps. Too many speed bumps already going through Sans Souci.	5/16/2021 6:29 AM
20	Ive lived on prentalhome road for 24 years now.Our road has always been a cut thru,if people didnt speed we'd be fine.. The police use to set up traps every week or so and that slowed people and traffic down alot. I really think that is a great resolution.. Bring back the speed trap/check points. Youll get more then speeders that way..	5/15/2021 4:03 PM
21	Due to the drainage ditches, the road/lanes already feel narrow. From Beach Blvd to Drew Park the sidewalk is adequate for peds/bikes, but no sidewalk from Drew Park to Bowden Road. Cut through traffic to/from South point contributes to most of the congestion and speeding.	5/14/2021 10:37 PM
22	A center lane would be nice too, but I doubt there is room for bike lanes, sidewalks, and a center lane along the whole corridor. It's pretty narrow with the existing homes along parts of it.	5/14/2021 9:04 PM

Parental Home Road Survey

Just please don't turn it into peach drive.

23	Any improvements in this survey must be done with an absolute minimum of tree damage or removal. If you remove too many trees from Parental Home Road you completely destroy it's character.	5/14/2021 6:27 PM
24	NO RAISED SPEED BUMPS like there are on Dean Road	5/14/2021 5:37 PM
25	My main concern is how fast people drive. Slowing them down is necessary	5/14/2021 2:24 PM
26	I live on Parental Home Road. I don't feel safe to walk along the sidewalk. Additional police speed enforcement would be nice. Speeding is a real problem. Widening of the road would be wonderful.	5/14/2021 1:29 PM
27	I live on Parental Home Road. It has become a raceway with vehicles traveling, 60 and 70mph. Often we have accidents with cars getting rear-ended when attempting to turn. Thank you for considering a project. We would appreciate any help to reduce the speed.	5/14/2021 1:09 PM
28	No speed bumps!!!!	5/14/2021 12:45 PM
29	I don't want the road closer to my house	5/14/2021 11:05 AM
30	Semis should not be allowed on this road. It is a residential neighborhood.	5/14/2021 10:13 AM
31	Please if you do anything, narrow the travel lanes and separate the walking paths/bicyclists from the roadway. Narrowing the travel lanes is something that has been proven to be most effective across the US and internationally at traffic calming and keeping our nonvehicular traffic 5-10 feet away has been proven to keep them safer as well.	5/14/2021 8:44 AM
32	While we need to curb the speeding, please no speed bumps	5/14/2021 8:34 AM
33	The cut through traffic on parental home also significantly impacts Hogan rd between Parental Home and Foster Drive, particularly as it relates to left turning vehicles traveling eastbound on that section. Traffic circles at these intersections would improve traffic flow and reduce the number of accidents at those intersections.	5/14/2021 7:50 AM
34	don't even think about speed bumps or humps!	5/14/2021 7:35 AM
35	This is a major travel route for me multiple times a day and an extended construction project would greatly disrupt my life.	5/14/2021 7:27 AM
36	Safety concerns for the children who walk to school/Southside junior high, plus car traffic from parents dropping off & picking up of students; safety of walkers or bikers accessing Drew Park.	5/14/2021 7:24 AM
37	The issues on parental home are also valid for East Rd and on Dean Rd. There is constant racing at all hours day and night. The speed humps done really stop the speeders on Dean Rd as they just jump them at high speeds and there's always kids at the park that could get hurt	5/14/2021 7:07 AM
38	PLEASE look into the problems this will create for surrounding streets, like East Road which will bear the brunt of the people who want to avoid slowing down. I'm afraid this is going to significantly exaserbate the problems we're having on East Road.	5/14/2021 5:56 AM
39	Drew Park needs to be made safer	5/13/2021 10:46 PM
40	Some speed bumps would help. Also sidewalks where needed as only part of the road has them.	5/13/2021 8:39 PM
41	None	5/13/2021 7:34 PM
42	Traffic is heavy at rush hour and it is hard to safely get out of driveway at times . Also we have a lot of vagrants population in our area that needs to be looked at. Lighting is another issue that could be expanded and the existing sidewalks are unlevel and very unsafe for special needs.	5/13/2021 6:16 PM
43	Sidewalks don't need to be 6 feet wide that is crazy. Figure out why so many cars and even big trucks are cutting through and fix that. Also hand out speeding tickets like candy and that will stop the speeding.	5/13/2021 5:32 PM
44	PLEASE keep the beautiful old oak trees near Parental Home and Bowden	5/13/2021 5:29 PM
45	More lighting, round about at dean and parental, wider sidewalks	5/13/2021 10:52 AM

Parental Home Road Survey

46	I live in a newly built 13 home community directly off Parental Home Rd. (Hanzas Ct.). I am the HOA president and will share this survey with the neighborhood on our FB group page. We moved from a similar street situation in Isle of Palms (Eunice Rd.), which was used as a cut through to avoid traffic on nearby San Pablo Rd. They installed speed humps (so, so many dang speed humps) and it was AWFUL. And it didn't even help because cut through traffic didn't decrease and people sped over the humps like it was a monster truck rally. I would much rather see roundabouts to slow traffic without stopping it, RRFB's to provide safer pedestrian crossing, and sidewalks along the entire road. Please, no humps!!!	5/13/2021 10:02 AM
47	Parental home needs to be upgraded due to the flow of traffic over that roadway	5/13/2021 8:49 AM
48	Please do not consider any 'improvements' that would imperil the century live oak stand at PH/Bowden. Very few spots like that exist anymore and it adds to the character of the neighborhood.	5/13/2021 1:05 AM
49	test survey	5/4/2021 11:08 AM